

2024

**Ragol<sup>®</sup>**

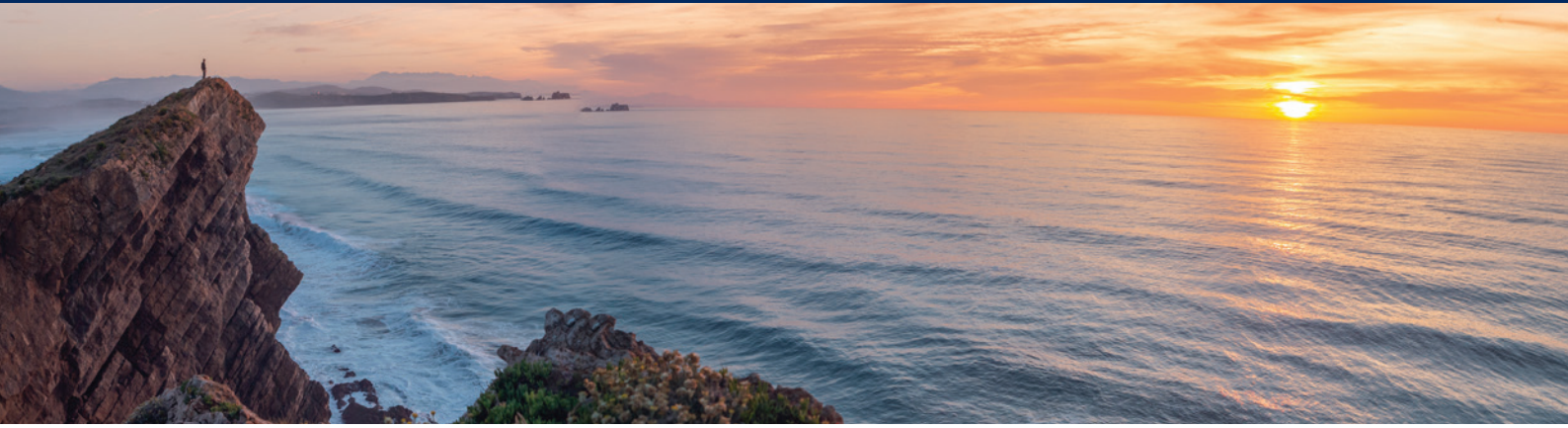

# SALES AND MARKETING OFFICES



## Group Headquarters

---

### **Rapala VMC Corporation**

Mäkeläkatu 91  
00610 Helsinki  
FINLAND  
[www.rapalavmc.com](http://www.rapalavmc.com)



## Logistic Center

---

### **Rapala VMC France**

ZI - 49, rue de l'Industrie  
90140 Bourogne  
FRANCE  
[contact-normark@rapala.fr](mailto:contact-normark@rapala.fr)  
+33(0)3 84 57 35 00

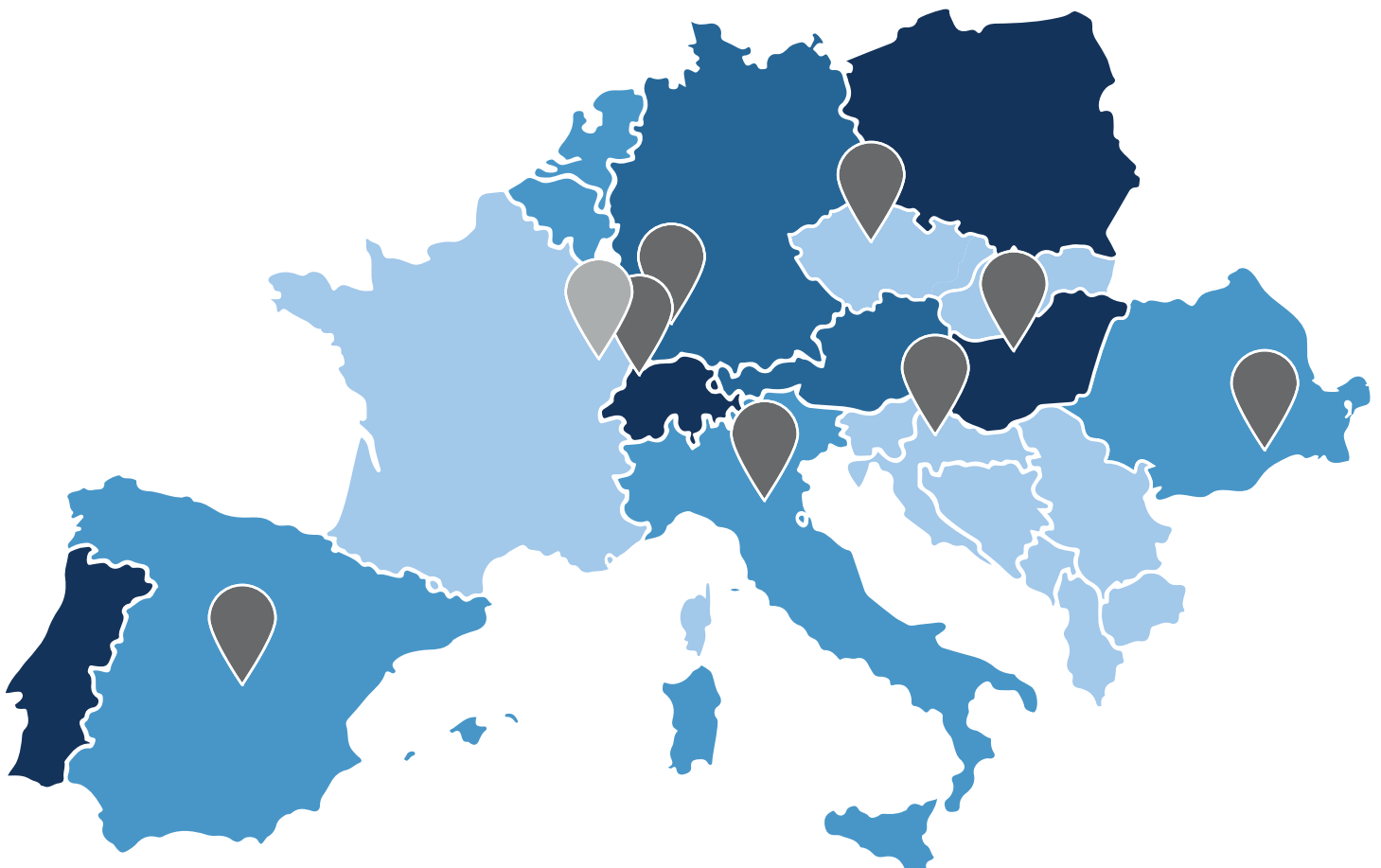



# SALES AND MARKETING OFFICES



## Rapala VMC Sales & Marketing Offices

### **Rapala VMC France**

ZI - 49, rue de l'Industrie  
90140 Bourogne  
FRANCE  
contact-normark@rapala.fr  
+33(0)3 84 57 35 00

### **Rapala VMC Italia srl**

Via Rodolfo Audinot 4  
40134 Bologna (BO)  
ITALIA  
+39 339 832 3605  
info@normarkitalia.it

### **Rapala VMC Deutschland GmbH**

Basler Straße 115  
79115 Freiburg  
DEUTSCHLAND  
+49 761 36949  
salesgermany@rapala.fr  
salesaustria@rapala.fr

### **Rapala VMC Spain**

Camino de lo cortao 19A  
28750 San Sebastian de los Reyes  
Madrid  
ESPAÑA  
ES: +34 918 487 277  
PO: +351 919 362 389  
info@normark.es

### **Rapala VMC Switzerland AG**

Allée des Soupirs 1  
2900 Porrentruy / JU  
SWITZERLAND  
+41 55 251 52 92  
s.stebler@rapala-fishco.ch

### **Rapala VMC Czech s.r.o**

Dopraváků 749/3  
Praha 8-Dolní Chabry, 184 00  
+420 725 944 791  
info@normark.cz

### **Rapala VMC Hungary Zrt.**

Fehérvári út 97-99.  
1119 Budapest  
HUNGARY  
+36 1 206 0702  
info@rapalavmc.hu

### **Rapala VMC ROMÂNIA S.R.L**

Str. Leordeni, Nr. 161S, Popesti Leordeni  
ROMANIA  
+40 751155044  
office@normark.ro

### **Rapala VMC Adriatic d.o.o.**

Velika cesta 22C  
10254 Odra-Zagreb  
CROATIA  
+385 1 4107 565  
info@normarkadriatik.hr





# INDEX

## A

ACCESSORIES.....	72-74,76-77
ACCESSORIES - SEA.....	124-128
ACCESSORIES - TROUT/TOC.....	80-81
AIR PUMPS.....	86-87
ALARMS.....	76
ALUMINIUM JOINTED HANDLE.....	172
ANGUILL®.....	154
ANTI-TANGLE BOOM.....	74,125
AQUADIVE®.....	128
AQUASURE®.....	120

## B

BACKING.....	168
BAGS.....	105-109
BAGS - SEA.....	111-112
BAIT COLLECTION.....	169-171
BAIT ELASTIC.....	128
BAITS.....	122
BAITS - SEA.....	171
BAKKAN.....	112
BANKSTICK.....	90
BASKET BAG.....	110
BEADS.....	77,125
BELLS.....	76
BOMBARDA.....	21-22
BOOTS.....	120
BOXES.....	82-85
BUCKETS.....	88
BULDO.....	37

## C

CAP.....	117
CASTING GLOVES.....	124
CATAPULT.....	73
CHAIR.....	114-115
CIVELIX®.....	163
CLIP SURF ROD.....	92
CLIPLIGHT.....	41
CLIPS.....	124
CLOTHES.....	116-117
COOKED SEEDS.....	122
COOLER.....	111
COPPER WIRE.....	79
CRAYFISH NET KIT.....	97

## D

DE-SCALER.....	128
DIAMOND EYE THREADER.....	74
DIODES.....	126
DISGORGERS.....	71
DOUBLE GODILLE.....	79
DRY BAG.....	111

## E

ELASTIC POLE CONNECTOR.....	73
END RIG WITH LEAD.....	135

## F

FIGHTING BELT.....	127
FINS.....	124
FISH BAG.....	170
FISH COUNTER.....	74
FISH TRAP.....	96
FISHING LINES.....	165
FISHING VEST.....	116-117
FLOAT - ELECTRIC.....	39

FLOAT - FINNESSE.....	16-19
FLOAT - KITS.....	42-43
FLOAT - LUMINOUS.....	39
FLOAT - MATCH.....	16
FLOAT - PLEASURE FISHING.....	20
FLOAT - PREDATORS.....	31-36
FLOAT - SEA.....	38-40
FLOAT - TROUT.....	23-30
FLOAT CONNECTOR - CLIP.....	74
FLOAT RUBBER ASSORTMENT.....	73
FLUOROCARBON.....	5
FOOT FISHING CHILD KIT.....	170

## G

GAFF.....	101
GAGS.....	72
GALVANISED NET.....	170-171
GLUE.....	120

## H

HANDLE.....	97
HEADLAMPS.....	127
HOOK SHARPENER.....	72
HOOK TO NYLON CLASSIC FRESHWATER.....	65-67
HOOK TO NYLON CLASSIC SEA.....	69-70
HOOK TO NYLON FLUOROCARBON FRESHWATER.....	62
HOOK TO NYLON FLUOROCARBON SEA.....	68
HOOK TO NYLON VANADIUM FRESHWATER.....	63-64

## I

IMITATION MOTH GRUB.....	80
--------------------------	----

## J

JIGS.....	145-151
-----------	---------

## K

KEEPNETS.....	93-96
KIT SUPPORTS.....	89
KNIFE.....	128

## L

LEADS.....	44-48
LINES.....	6-15
LONGLINE BRASS RING.....	47
LONGLINE RAPID CLIP.....	168

## M

MAGGOTS BAG.....	80
MAGNETIC BOX.....	82
METAL CAGE FEEDER.....	74
METRE RULER.....	76
METRE TRAY.....	127
MITRAILLETES.....	136-143
MULTI USE BAG.....	108
MUSETTE BAGS.....	109
MYSTIC.....	121

## N

NEEDLES.....	75
NET HEAD.....	101
NETS.....	98-100,104
NETS.....	171

## P

PELLET BANDER + 30 BANDS.....	74
PELLET BANDS.....	74
PLAICE CARRIER.....	96

PLIERS.....	72
POLYSTYRENE BALLS.....	81
PORTE STARLITE.....	40
POUND NET.....	88
PRETECTOR MULTICOLOR.....	80

## R

RACKETS.....	102-103
RAGLOU®.....	156-161
RAGLOU® HYBRID.....	162
RAGLOU® SPID.....	163
RAGLOU® TIGER.....	155
RAGTENYA.....	152-153
RAGTUNA.....	164
RAPID SNAP.....	124
RIG ANCHORS.....	73,74
RIGS - COMMERCIAL.....	54
RIGS - FINESSE.....	49-54
RIGS - KITS.....	60-61
RIGS - PLEASURE FISHING.....	55-56
RIGS - PREDATOR.....	59-60
RIGS - SEA.....	59-60
RIGS - TROUT.....	56-58
ROD HOLDALL.....	105-108,111
ROD REST.....	90-91
ROD TUBE.....	110
ROLLERS.....	89
RUBBER BANDS.....	73
RUBBER WASHERS.....	73
RUN CLIP.....	76

## S

SALTWATER METHOD.....	128
SANDOWS.....	78
SARDINE OIL.....	171
SCALE.....	76
SCISSORS.....	128
SEA RIGS.....	130-135
SEAT BOX.....	115
SEATS.....	114-115
SHRIMPS NETS.....	97
SLIDING STOP BEADS.....	74
SLIDING SWIVELS AND CLIPS.....	124,125
SQUID JIG.....	126
STAINLESS COATED WIRE.....	79
STAINLESS STEEL PIANO WIRE.....	79
STARLIGHT.....	41
STEEL CLIPS PATERNOSTER.....	135
STOP FLOAT.....	77
STORMSURE.....	120
STROUILLE.....	171
SURF BANKSTICK.....	92
SURF SUPPORT.....	92

## T

TELESCOPIC BEACH NET.....	104
TIPS.....	78
TRIPOD.....	91
TROLLEYS.....	113
TROLLING LINES.....	166-168

## U

UMBRELLAS.....	93
----------------	----

## W

WADERS.....	118-119
WINDERS.....	129
WIRE GUIDE.....	81



NEW FOR 2024



NEW SIZE CODE



NEW COLOR CODE



# FLUOROCARBON



- 100% Fluorocarbon
- Refraction index close to that of water
  - Invisible underwater
  - Is used in all clear waters
  - Exceptional abrasion resistance
  - Superior nylon resistance thanks to perfect impermeability
  - Flows three times faster than a traditional thread
  - Perfectly dampens shocks

PVDF FLUOROCARBON 25 m				
Code	Ø	Strength	Gencod	RRP (€)
010017010	0,10 mm	1 kg	[Barcode]	7,85
012017010	0,125 mm	1,5 kg	[Barcode]	7,85
015017010	0,15 mm	2 kg	[Barcode]	7,85
017017010	0,175 mm	2,5 kg	[Barcode]	7,85
020017010	0,20 mm	3,4 kg	[Barcode]	7,85
022017010	0,225 mm	3,9 kg	[Barcode]	7,85
025017010	0,25 mm	5,2 kg	[Barcode]	8,99
027017010	0,275 mm	5,9 kg	[Barcode]	8,99
030017010	0,30 mm	6,4 kg	[Barcode]	8,99
035017010	0,35 mm	8,2 kg	[Barcode]	10,50
040017010	0,40 mm	11,3 kg	[Barcode]	10,50
045017010	0,45 mm	12,9 kg	[Barcode]	11,80
050017010	0,50 mm	15 kg	[Barcode]	11,80
060017010	0,60 mm	20,5 kg	[Barcode]	15,70
AWQ470023	0,70 mm	32,4 kg	[Barcode]	23,30
AWQ470024	0,80 mm	35,6 kg	[Barcode]	28,90
AWQ470133	0,90 mm	43,2 kg	[Barcode]	38,50

Trade Pack: x6



- Refractive index close to that of water.
- Almost invisible underwater.
- Exceptional abrasion resistance.
- Superior nylon resistance thanks to perfect impermeability.
- Flows three times faster than a traditional thread.
- Perfectly dampens shocks.

TRIDENT VX FLUORO 50 m				
Code	Ø	Strength	Gencod	RRP (€)
RG4700018	0,125 mm	1,5 kg	[Barcode]	11,90
RG4700019	0,15 mm	2 kg	[Barcode]	11,90
ATO470062	0,175 mm	2,5 kg	[Barcode]	12,40
ATO470063	0,20 mm	3,4 kg	[Barcode]	12,40
ATO470064	0,225 mm	3,9 kg	[Barcode]	12,40
ATO470065	0,25 mm	5,2 kg	[Barcode]	14,85
ATO470066	0,275 mm	5,9 kg	[Barcode]	14,85
ATO470067	0,30 mm	6,4 kg	[Barcode]	16,05
ATO470068	0,35 mm	8,2 kg	[Barcode]	17,25
ATO470069	0,40 mm	11,3 kg	[Barcode]	21,00
ATO470070	0,45 mm	12,9 kg	[Barcode]	23,50
ATO470071	0,50 mm	15 kg	[Barcode]	27,15
ATO470072	0,60 mm	20,5 kg	[Barcode]	35,85
ATO470109	0,70 mm	32,4 kg	[Barcode]	44,50

Trade Pack: x6



# LINES

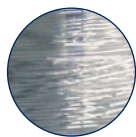

- Nylon combining all the specificities of a high-end nylon.
- High quality copolymers.
- High resistance to knots.
- High resistance to abrasion.
- Reduced elongation for better control of the line.
- Joined spools for loading on to larger reels and less memory.
- Very good glide.
- VX FORCE, universal transparent color suitable for all types of fishing.



TRIDENT VX FORCE 150 m

Code	Ø	Strength	Gencod	RRP (€)
ATO470041	0,16 mm	3,1 kg		11,90
ATO470042	0,18 mm	3,7 kg		11,90
ATO470043	0,20 mm	4,5 kg		11,90
ATO470044	0,225 mm	5,7 kg		13,60
ATO470045	0,25 mm	7,1 kg		13,60
ATO470046	0,28 mm	9,1 kg		14,90
ATO470047	0,30 mm	10 kg		14,90
ATO470048	0,35 mm	13,1 kg		15,90
ATO470049	0,40 mm	15,6 kg		17,50

Trade Pack: x6



TRIDENT VX FORCE 300 m

Code	Ø	Strength	Gencod	RRP (€)
ATO470012	0,20 mm	4,5 kg		18,30
ATO470013	0,225 mm	5,7 kg		18,30
ATO470014	0,25 mm	7,1 kg		19,80
ATO470015	0,28 mm	9,1 kg		21,30
ATO470016	0,30 mm	10 kg		23,10
ATO470017	0,35 mm	13,1 kg		25,90
ATO470018	0,4 mm	15,6 kg		28,40
ATO470019	0,45 mm	18,3 kg		30,70
ATO470020	0,50 mm	23,1 kg		32,90
ATO470021	0,60 mm	27,4 kg		34,90

Trade Pack: x6

NEW 2024



TRIDENT VX FORCE 1000 m

Code	Ø	Strength	Gencod	RRP (€)
RG4700020	0,20 mm	4,5 kg		24,90
RG4700021	0,225 mm	5,7 kg		24,90
RG4700009	0,25 mm	7,1 kg		29,90
RG4700010	0,28 mm	9,1 kg		29,90
RG4700011	0,30 mm	10 kg		29,90
RG4700012	0,35 mm	13,1 kg		33,80
RG4700013	0,4 mm	15,6 kg		36,80
RG4700014	0,5 mm	23,1 kg		51,20
RG4700015	0,6 mm	27,4 kg		57,30
RG4700016	0,7 mm	37,1 kg		68,60
RG4700017	0,8 mm	51,5 kg		78,90

Trade Pack: x1





Highly visible red color particularly suitable for Surf-casting or long-distance fishing.



TRIDENT VX SURF 300 m				
Code	Ø	Strength	Gencod	RRP (€)
ATO470023	0,30 mm	10 kg		21,30
ATO470024	0,35 mm	13,1 kg		22,95
ATO470025	0,40 mm	15,6 kg		25,50
ATO470026	0,45 mm	18,3 kg		28,00

Trade Pack: x6



- Nylon specially designed for all sea fishing
- From Ø30 to Ø80
- Exceptional abrasion resistance
- High knot strength
- Low visibility colour
- Perfectly adapts to the water temperature
- Designed with optimum stretch



TRIDENT 150 m				
Code	Ø	Strength	Gencod	RRP (€)
TRIC03000	0,30 mm	8,3 kg		12,95
TRIC03500	0,35 mm	11,1 kg		12,95
TRIC04000	0,40 mm	14,4 kg		12,95
TRIC04500	0,45 mm	17,65 kg		16,85
TRIC05000	0,50 mm	21,6 kg		18,15
TRIC06000	0,60 mm	30,1 kg		20,80
TRIC07000	0,70 mm	40,6 kg		22,10
TRIC08000	0,80 mm	51,6 kg		23,34

Trade Pack: x6



TRIDENT 300 m				
Code	Ø	Strength	Gencod	RRP (€)
TRI503000	0,30 mm	8,3 kg		19,40
TRI503500	0,35 mm	11,1 kg		19,40
TRI504000	0,40 mm	14,4 kg		19,40
TRI504500	0,45 mm	17,65 kg		24,75
TRI505000	0,50 mm	21,6 kg		27,25
TRI506000	0,60 mm	30,1 kg		29,90
TRI507000	0,70 mm	40,6 kg		32,45

Trade Pack: x6



High quality nylon recommended for feeder fishing. Silicone coating for a perfect slip in the rings. High resistance to abrasion, and excellent resistance to knots.

- Flows easily.
- Purple color perfectly adapted to this type of fishing.

FEEDER 200 m				
Code	Ø	Strength	Gencod	RRP (€)
022134134	0,20 mm	3,3 kg		11,90
024134134	0,225 mm	4,2 kg		11,90
026134134	0,25 mm	5,2 kg		11,90
028134134	0,275 mm	6,2 kg		11,90

Trade Pack: x6



- Low elasticity
- Very flowing
- Long and accurate throws
- Real-time shoeing
- Ultra-soft finish, very soft feel
- Unparalleled performance in high level competition

SPECIAL MATCH 150 m				
Code	Ø	Strength	Gencod	RRP (€)
413056015	0,135 mm	1,7 kg		10,40
415056015	0,15 mm	2,1 kg		10,40
418056015	0,175 mm	2,7 kg		10,40
420056015	0,20 mm	3,5 kg		10,40
422056015	0,225 mm	4,2 kg		10,40
425056015	0,25 mm	5 kg		10,40

Trade Pack: x6

- Excellent strength / diameter ratio
- Abrasion resistant
- High knot strength
- Controlled stretch (higher stretch in small diameters, lower in larger)
- Transparent design aids low visibility



POLE FISHING 25 m				
Code	Ø	Strength	Gencod	RRP (€)
010017015	0,10 mm	1,18 kg		6,15
012017015	0,12 mm	1,44 kg		6,15
014017015	0,14 mm	2,28 kg		6,15
016017015	0,16 mm	2,8 kg		6,15
018017015	0,18 mm	3,25 kg		6,15

Trade Pack: x6



POLE FISHING 100 m				
Code	Ø	Strength	Gencod	RRP (€)
008047015	0,08 mm	0,77 kg		13,05
010047015	0,10 mm	1,18 kg		13,05
012047015	0,12 mm	1,44 kg		13,05
014047015	0,14 mm	2,28 kg		13,05
016047015	0,16 mm	2,8 kg		13,05
018047015	0,18 mm	3,25 kg		13,05
020047015	0,20 mm	3,89 kg		13,05

Trade Pack: x6





- Fluorocarbon coating
- Smooth and constant surface
- Blue coloring at U.V
- High resistance to knots and abrasion

CASTING CLEAR 200 m				
Code	Ø	Strength	Gencod	RRP (€)
017133130	0,175 mm	3 kg		14,35
020133130	0,20 mm	3,6 kg		14,35
022133130	0,225 mm	4,5 kg		14,35
025133130	0,25 mm	5,8 kg		16,30
027133130	0,275 mm	6,7 kg		16,30
030133130	0,30 mm	9,3 kg		16,30
035133130	0,35 mm	10 kg		16,30

Trade Pack: x6



- Transparent and universal nylon
- Suitable for all fishing
- Strong and reliable

CLEAR LINE 100 m				
Code	Ø	Strength	Gencod	RRP (€)
AWQ470037	0,10 mm	1 kg		4,75
AWQ470038	0,12 mm	1,2 kg		4,75
AWQ470039	0,14 mm	1,5 kg		4,75
AWQ470001	0,16 mm	1,8 kg		4,75
AWQ470002	0,18 mm	2,2 kg		4,75
AWQ470003	0,20 mm	2,7 kg		4,75
AWQ470004	0,22 mm	3,5 kg		4,75
AWQ470005	0,24 mm	4,3 kg		4,75
AWQ470006	0,26 mm	4,6 kg		4,75
AWQ470007	0,28 mm	5,3 kg		4,75
AWQ470008	0,30 mm	6,1 kg		4,75
AWQ470009	0,35 mm	7,6 kg		4,75

Trade Pack: x6





# LINES

- A nylon that has proven itself in freshwater as well as in the sea.
- Available in a wide range of diameters, it is as reliable as it is versatile.



## SUPER CONTROL GREEN CONNECTED 100 m

Code	Ø	Strength	Gencod	RRP (€)
VER302600	0,26 mm	4,2 kg		3,95
VER302800	0,28 mm	4,8 kg		3,95
VER303000	0,30 mm	5,4 kg		5,20
VER303500	0,35 mm	7,4 kg		5,20
VER304000	0,40 mm	9,75 kg		6,60
VER304500	0,45 mm	12,3 kg		6,60
VER305000	0,50 mm	14,8 kg		7,30
VER305500	0,55 mm	17,2 kg		7,65
VER306000	0,60 mm	20,9 kg		7,85
VER307000	0,70 mm	26,25 kg		9,15
Trade Pack: x12				
VER308000	0,80 mm	34,65 kg		11,65
VER309000	0,90 mm	41,8 kg		15,70

Trade Pack: x6



## SUPER CONTROL CRISTAL CONNECTED 100 m

Code	Ø	Strength	Gencod	RRP (€)
CRI302000	0,20 mm	2,65 kg		3,95
CRI302400	0,24 mm	4 kg		3,95
CRI302600	0,26 mm	4,2 kg		3,95
CRI302800	0,28 mm	4,8 kg		3,95
CRI303000	0,30 mm	5,4 kg		5,20
CRI303500	0,35 mm	7,4 kg		5,20
CRI304000	0,40 mm	9,75 kg		6,60
CRI304500	0,45 mm	12,3 kg		6,60
CRI305000	0,50 mm	14,8 kg		7,30
CRI306000	0,60 mm	17,2 kg		7,85
CRI307000	0,70 mm	20,9 kg		9,15
CRI308000	0,80 mm	26,25 kg		11,65
Trade Pack: x12				
CRI309000	0,90 mm	34,65 kg		15,70
CRI310000	1,00 mm	41,8 kg		16,90

Trade Pack: x6



# LINES

A family of monofilaments specially selected by type of fish. A perfect mimicry with colors adapted to the water. A high resistance to knot and abrasion, as well as a length designed for a perfect filling of the reels. Outstanding durability for an excellent price/quality ratio.



PASSION PIKE 150 m				
Code	Ø	Strength	Gencod	RRP (€)
028050411	0,28 mm	5,9 kg		7,85
030050411	0,30 mm	7 kg		7,85
035050411	0,35 mm	9,3 kg		7,85
040050411	0,40 mm	11,9 kg		7,85

Trade Pack: x6



PASSION CARP 300 m				
Code	Ø	Strength	Gencod	RRP (€)
030151410	0,30 mm	7,1 kg		14,35
035151410	0,35 mm	9,1 kg		14,35
040151410	0,40 mm	11,3 kg		14,35

Trade Pack: x6



PASSION FLURO 150 m				
Code	Ø	Strength	Gencod	RRP (€)
017050411	0,175 mm	2,4 kg		7,85
020050411	0,20 mm	3 kg		7,85
022050411	0,225 mm	3,5 kg		7,85
025050411	0,25 mm	4,3 kg		7,85
027050411	0,275 mm	5,2 kg		7,85
030051411	0,30 mm	6,2 kg		7,85
035051411	0,35 mm	8,1 kg		7,85

Trade Pack: x6



PASSION ROACH 100 m				
Code	Ø	Strength	Gencod	RRP (€)
008040411	0,08 mm	0,7 kg		6,60
010040411	0,10 mm	1 kg		6,60
012040411	0,12 mm	1,3 kg		6,60
014040411	0,14 mm	1,8 kg		6,60
016040411	0,16 mm	2,2 kg		6,60

Trade Pack: x6



# LINES

A family of monofilaments specially selected by type of fish. A perfect mimicry with colors adapted to the water. A high resistance to knot and abrasion, as well as a length designed for a perfect filling of the reels. Outstanding durability for an excellent price/quality ratio.



## PASSION ZANDER 150 m

Code	Ø	Strength	Gencod	RRP (€)
022050414	0,225 mm	4,2 kg		7,85
025050414	0,25 mm	5,2 kg		7,85
027050414	0,275 mm	6,3 kg		7,85
030050414	0,30 mm	7,2 kg		7,85

Trade Pack: x6



## PASSION CATFISH 300 m

Code	Ø	Strength	Gencod	RRP (€)
050151411	0,50 mm	16 kg		18,40
060151411	0,60 mm	22 kg		18,40
070151411	0,70 mm	27,5 kg		18,40

Trade Pack: x6



## PASSION TROUT 150 m

Code	Ø	Strength	Gencod	RRP (€)
015050412	0,15 mm	2,2 kg		7,85
017050412	0,175 mm	2,9 kg		7,85
020050412	0,20 mm	3,6 kg		7,85
022050412	0,22 mm	4,2 kg		7,85
025050412	0,25 mm	5,4 kg		7,85

Trade Pack: x6



# LINES

Range of nylons specially selected by fishing type:  
 - Color adapted to each type of fishing or fish.  
 - Length of nylon studied for a perfect filling of the reels.  
 - Excellent price / quality ratio.



## PIKE 500 m

Code	Ø	Strength	Gencod	RRP (€)
AWQ470099	0,28 mm	5,6 kg		9,50
AWQ470086	0,30 mm	6,5 kg		9,50
AWQ470087	0,35 mm	8,1 kg		9,50
AWQ470088	0,40 mm	11,2 kg		9,50

Trade Pack: x6



## CARP 480 m

Code	Ø	Strength	Gencod	RRP (€)
AWQ470095	0,30 mm	6,5 kg		9,50
AWQ470096	0,35 mm	8,1 kg		9,50
AWQ470097	0,40 mm	11,2 kg		9,50

Trade Pack: x6



## ZANDER 500 m

Code	Ø	Strength	Gencod	RRP (€)
AWQ470089	0,225 mm	3,6 kg		9,50
AWQ470090	0,25 mm	4,8 kg		9,50
AWQ470091	0,275 mm	5,6 kg		9,50

Trade Pack: x6



## TROUT 500 m

Code	Ø	Strength	Gencod	RRP (€)
AWQ470098	0,175 mm	2,6 kg		9,50
AWQ470092	0,20 mm	3,3 kg		9,50
AWQ470093	0,225 mm	3,6 kg		9,50
AWQ470094	0,25 mm	4,9 kg		9,50

Trade Pack: x6

# LINES

Range of nylons specially selected by fishing type:  
 - Color adapted to each type of fishing or fish.  
 - Length of nylon studied for a perfect filling of the reels.  
 - Excellent price / quality ratio.



BASS						
Code	Ø	Strength	Size	Gencod	RRP (€)	
ATO470094	0,30 mm	6,5 kg	480 m		9,50	
ATO470095	0,35 mm	8,1 kg	360 m		9,50	
ATO470096	0,40 mm	11,2 kg	280 m		9,50	
ATO470134	0,45 mm	13,2 kg	220 m		9,50	

Trade Pack: x6



SEA BREAM						
Code	Ø	Strength	Size	Gencod	RRP (€)	
ATO470089	0,275 mm	5,6 kg	500 m		9,50	
ATO470090	0,30 mm	6,5 kg	480 m		9,50	
ATO470091	0,35 mm	8,1 kg	360 m		9,50	

Trade Pack: x6



MACKEREL						
Code	Ø	Strength	Size	Gencod	RRP (€)	
ATO470119	0,35 mm	8,1 kg	360 m		9,50	
ATO470120	0,40 mm	11,2 kg	280 m		9,50	
ATO470136	0,45 mm	13,2 kg	220 m		9,50	
ATO470121	0,50 mm	16 kg	180 m		9,50	

Trade Pack: x6



# LINES

Range of nylons specially selected by fishing type:  
 - Color adapted to each type of fishing or fish.  
 - Length of nylon studied for a perfect filling of the reels.  
 - Excellent price / quality ratio.



SEA						
Code	Ø	Strength	Size	Gencod	RRP (€)	
ATO470122	0,275 mm	5,6 kg	500 m		9,50	
ATO470123	0,30 mm	6,5 kg	480 m		9,50	
ATO470124	0,35 mm	8,1 kg	360 m		9,50	
ATO470125	0,40 mm	11,2 kg	280 m		9,50	
ATO470137	0,45 mm	13,2 kg	220 m		9,50	
ATO470126	0,50 mm	16 kg	180 m		10,55	
ATO470127	0,60 mm	23,3 kg	140 m		11,80	

Trade Pack: x6



SURF FLUO						
Code	Ø	Strength	Size	Gencod	RRP (€)	
RG4700001	0,35 mm	9,4 kg	300 m		10,30	
RG4700002	0,40 mm	11,9 kg	300 m		11,45	
RG4700003	0,50 mm	17,1 kg	300 m		12,60	

Trade Pack: x6



# FLOATS MATCH



BRIGHTON				
Code	Weight	Gencod	RRP (€)	
153901271	3+1 g		5,05	
153902271	4+1 g		5,05	
153903271	6+2 g		5,05	
153904271	8+2 g		5,05	
153905271	10+2 g		5,05	

Trade Pack: x6 (1 per Bag)



INM PICOLLO				
Code	Weight	Gencod	RRP (€)	
103402141	4+1 g		5,05	
103403141	5+1 g		5,05	
103404141	7+1 g		5,05	
103405141	9+1 g		5,05	
AWQ330215	11+1 g		5,05	

Trade Pack: x6 (1 per Bag)

# FLOATS FINESSE



ANDLAU				
Code	Weight	Gencod	RRP (€)	
150001271	0,4 g		2,49	
150002271	0,6 g		2,49	
150003271	0,8 g		2,49	

Trade Pack: x12 (Bulk)



BEUVE						
Weight	Code	Gencod	RRP (€)	Code	Gencod	RRP (€)
		BULK		2 PER BAG		
0,6 g	103602091		2,49	204202091		5,65
0,8 g	103603091		2,49	204203091		5,65
1 g	103604091		2,49	204204091		5,65
1,5 g	103605091		2,49	-	-	-
2 g	103606091		2,49	-	-	-

Trade Pack: x12

Trade Pack: x6

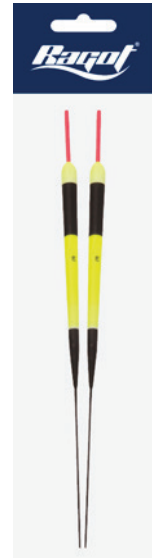

# FLOATS FINESSE



L1			
Code	Weight	Gencod	RRP (€)
RG3200018	0,4 g		2,49
RG3200019	0,6 g		2,49
RG3200020	0,8 g		2,49
RG3200021	1 g		2,49
RG3200022	1,5 g		2,49
RG3200023	2 g		2,49

Trade Pack: x12 (Bulk)



L2			
Code	Weight	Gencod	RRP (€)
RG3200024	0,4 g		2,49
RG3200025	0,6 g		2,49
RG3200026	0,8 g		2,49
RG3200027	1 g		2,49
RG3200028	1,5 g		2,49
RG3200029	2 g		2,49

Trade Pack: x12 (Bulk)



L3			
Code	Weight	Gencod	RRP (€)
RG3200030	0,4 g		2,49
RG3200031	0,6 g		2,49
RG3200032	0,8 g		2,49
RG3200033	1 g		2,49
RG3200034	1,5 g		2,49
RG3200035	2 g		2,49

Trade Pack: x12 (Bulk)



L4			
Code	Weight	Gencod	RRP (€)
RG3200036	0,4 g		2,49
RG3200037	0,6 g		2,49
RG3200038	0,8 g		2,49
RG3200039	1 g		2,49
RG3200040	1,5 g		2,49
RG3200041	2 g		2,49

Trade Pack: x12 (Bulk)



L5			
Code	Weight	Gencod	RRP (€)
RG3200042	0,4 g		2,49
RG3200043	0,6 g		2,49
RG3200044	0,8 g		2,49
RG3200045	1 g		2,49
RG3200046	1,5 g		2,49
RG3200047	2 g		2,49

Trade Pack: x12 (Bulk)

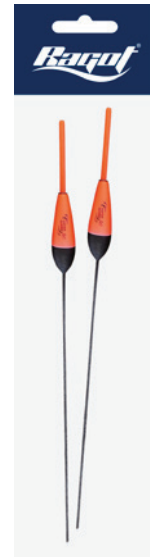

BORNE			
Code	Weight	Gencod	RRP (€)
AWQ330045	0,6 g		5,65
AWQ330046	0,8 g		5,65
AWQ330047	1 g		5,65

Trade Pack: x6 (2 per Bag)



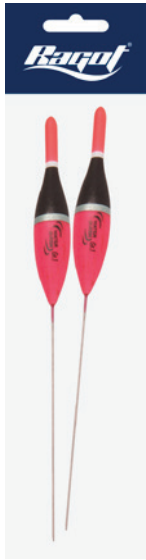

## CORBIONNE

Code	Weight	Gencod	RRP (€)
349702091	0,6 g		5,65
349803091	0,8 g		5,65

Trade Pack: x6 (2 per Bag)



## GARDON

Code	Weight	Gencod	RRP (€)
349002091	0,6 g		5,65
349103091	0,8 g		5,65
349203091	1 g		5,65

Trade Pack: x6 (2 per Bag)



## MUSSY

Code	Weight	Gencod	RRP (€)
RG3200056	0,4 g		2,49
RG3200057	0,6 g		2,49
RG3200058	0,8 g		2,49
RG3200059	1 g		2,49

Trade Pack: x12 (Bulk)



## ORBIZE

Code	Weight	Gencod	RRP (€)
115103271	1 g		2,49
115104271	1,5 g		2,49
115105271	2 g		2,49
115106271	3 g		2,49
115107271	4 g		2,49

Trade Pack: x12 (Bulk)



## OUERE

Code	Weight	Gencod	RRP (€)
101104141	0,8 g		2,49
101105141	1 g		2,49
101106141	1,5 g		2,49

Trade Pack: x12 (Bulk)



## PAGANINI

Code	Weight	Gencod	RRP (€)
RG3200064	0,4 g		2,49
RG3200065	0,6 g		2,49
RG3200066	0,8 g		2,49
RG3200067	1 g		2,49

Trade Pack: x12 (Bulk)

# FLOATS FINESSE



RODE			
Code	Weight	Gencod	RRP (€)
RG3200072	0,4 g		2,49
RG3200073	0,6 g		2,49
RG3200074	0,8 g		2,49
RG3200075	1 g		2,49

Trade Pack: x12 (Bulk)

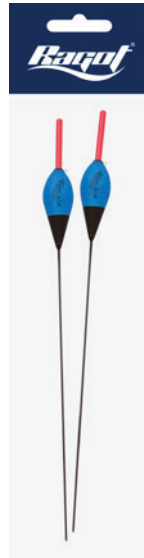

SCORE			
Code	Weight	Gencod	RRP (€)
AWQ330048	0,8 g		5,90
AWQ330049	1 g		5,90
AWQ330050	1,5 g		5,90

Trade Pack: x6 (2 per Bag)



VIERES			
Code	Weight	Gencod	RRP (€)
AWQ320106	0,4 g		2,49
AWQ320107	0,6 g		2,49
AWQ320108	0,8 g		2,49
AWQ320195	1 g		2,49

Trade Pack: x12 (Bulk)



VERSAILLES RED						
Weight	Code	Gencod	RRP (€)	Code	Gencod	RRP (€)
		BULK			2 PER BAG	
0,2 g	100102092		1,79	-	-	-
0,3 g	100103092		1,79	113203091		4,15
0,5 g	100104092		1,79	-	-	-
0,6 g	100105092		1,79	113405091		4,15
1 g	100106092		1,79	113506091		4,15
1,5 g	100107092		1,79	-	-	-
2,5 g	100108092		1,79	-	-	-

Trade Pack: x12

Trade Pack: x6

# FLOATS PLEASURE FISHING



FLOPPY						
Weight	Code	Gencod	RRP (€)	Code	Gencod	RRP (€)
BULK				2 PER BAG		
0,55 g	190001081		1,79	-	-	-
1 g	190002081		1,79	148502091		4,15
1,5 g	190003081		1,79	186103091		4,15
2 g	190004081		1,79	-	-	-
3 g	190005081		1,79	-	-	-
5 g	190006081		1,79	-	-	-
7 g	190007081		1,79	-	-	-
Trade Pack: x12				Trade Pack: x6		



MONTJOIE			
Code	Weight	Gencod	RRP (€)
100702091	0,2 g		1,79
100703091	0,3 g		1,79
100704091	0,5 g		1,79
100705091	0,6 g		1,79
100706091	0,8 g		1,79
100707091	1 g		1,79
Trade Pack: x12 (Bulk)			



ROYAL			
Code	Weight	Gencod	RRP (€)
100308118	0,5 g		2,19
100302112	0,8 g		2,19
100303113	1,2 g		2,19
100304114	2 g		2,19
100305115	3 g		2,19
Trade Pack: x12 (Bulk)			



TRANSAT			
Code	Weight	Gencod	RRP (€)
104802091	1,5 g		2,39
104803091	2,5 g		2,39
104804091	5 g		2,39
104805091	7 g		2,39
Trade Pack: x12 (Bulk)			



# FLOATS BOMBARDA FLOATS



FLOATING						
Weight	Code	Gencod	RRP (€)	Code	Gencod	RRP (€)
BULK			1 PER BAG			
6 g	100103141		3,60	-	-	-
8 g	100104141		3,60	-	-	-
10 g	100105141		3,60	123650091		4,55
15 g	100106141		3,60	195560091		4,55
20 g	100107141		3,60	-	-	-
30 g	100108141		3,60	-	-	-

Trade Pack: x12 Trade Pack: x6



DIVING			
Code	Weight	Gencod	RRP (€)
100205141	10 g		3,60
100206141	15 g		3,60
100207141	20 g		3,60
100208141	30 g		3,60

Trade Pack: x12 (Bulk)



SEMI-DIVING			
Code	Weight	Gencod	RRP (€)
100305141	20 g		3,60

Trade Pack: x12 (Bulk)



BOMBARDE DISTANZ			
Code	Weight	Gencod	RRP (€)
AWQ330147	10 g		6,35
AWQ330148	15 g		6,35
AWQ330149	20 g		6,35
AWQ330150	30 g		6,35

Trade Pack: x6 (1 per Bag)

# FLOATS BOMBARDA FLOATS



OPAQUE FLOATING						
Weight	Code	Gencod	RRP (€)	Code	Gencod	RRP (€)
BULK			1 PER BAG			
10 g	-	-	-	394201091		3,70
15 g	101702141		3,15	394302091		3,70
20 g	101703141		3,15	394403091		3,70
30 g	101704141		3,25	394505091		3,95
40 g	101705141		4,25	AWQ330263		4,85
60 g	-	-	-	AWQ330280		6,15
Trade Pack: x12			Trade Pack: x6			



OPAQUE SEMI-DIVING						
Weight	Code	Gencod	RRP (€)	Code	Gencod	RRP (€)
BULK			1 PER BAG			
10 g	AWQ320086		3,25	-	-	-
15 g	AWQ320087		3,25	AWQ330055		3,95
20 g	AWQ320088		3,25	AWQ330056		3,95
25 g	AWQ321262		3,25	-	-	-
30 g	AWQ320089		3,50	AWQ330057		4,15
40 g	-	-	-	AWQ330058		5,55
50 g	-	-	-	AWQ330059		6,15
60 g	-	-	-	AWQ330025		6,40
Trade Pack: x12			Trade Pack: x6			



TRANSPARENT DIVING						
Weight	Code	Gencod	RRP (€)	Code	Gencod	RRP (€)
BULK			1 PER BAG			
10 g	AWQ320001		3,25	AWQ330005		3,95
15 g	AWQ320002		3,25	AWQ330006		3,95
20 g	AWQ320003		3,25	AWQ330007		3,95
25 g	AWQ321263		3,25	-	-	-
30 g	AWQ320004		3,60	AWQ330008		4,15
40 g	AWQ320005		4,65	AWQ330009		5,55
50 g	-	-	-	AWQ330010		6,15
60 g	RG3200198		6,00	-	-	-
80 g	RG3200199		7,00	-	-	-
Trade Pack: x12			Trade Pack: x6			



# FLOATS TROUT



ASCHEN			
Code	Weight	Gencod	RRP (€)
AWQ320039	2,5 g		3,25
AWQ320045	4,5 g		3,25
AWQ320046	6 g		3,25
AWQ320047	8 g		3,25

Trade Pack: x12 (Bulk)

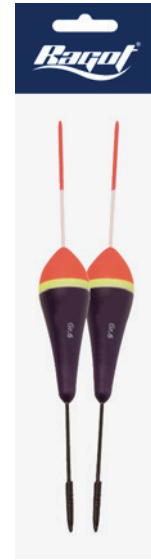

API						
Weight	Code	Gencod	RRP (€)	Code	Gencod	RRP (€)
BULK				2 PER BAG		
0,8 g	100703113		2,55	-	-	-
1,7 g	100704114		2,55	-	-	-
2,2 g	100705115		2,55	-	-	-
3 g	100706116		2,55	115406091		5,65
4 g	100707117		2,55	194207091		5,65
5 g	100708118		2,55	AWQ330086		5,65

Trade Pack: x12

Trade Pack: x6



CEROU			
Code	Weight	Gencod	RRP (€)
AWQ321220	1 g		2,55
AWQ321222	2 g		2,55
AWQ321224	3 g		2,55
AWQ321226	4 g		2,55
AWQ321227	5 g		2,55
AWQ321228	6 g		2,55
AWQ321229	8 g		2,55

Trade Pack: x12 (Bulk)



CEROU SPLIT			
Code	Weight	Gencod	RRP (€)
AWQ321235	1 g		2,55
AWQ321237	2 g		2,55
AWQ321239	3 g		2,55
AWQ321241	4 g		2,55
AWQ321242	5 g		2,55
AWQ321243	6 g		2,55

Trade Pack: x12 (Bulk)



ECHEZ			
Code	Weight	Gencod	RRP (€)
RG3200099	2 g		2,55
RG3200100	3 g		2,55
RG3200101	4 g		2,55
RG3200102	5 g		2,55

Trade Pack: x12 (Bulk)



# FLOATS TROUT

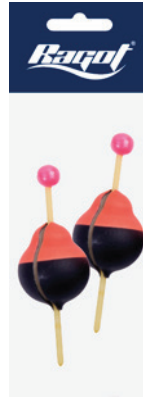

ERVE SPLIT							
Weight	Code	Gencod	RRP (€)	Code	Gencod	RRP (€)	
BULK				2 PER BAG			
1 g	AWQ320228		2,65	-	-	-	
1,5 g	-	-	-	AWQ330104		5,90	
2 g	AWQ320230		2,65	AWQ330284		5,90	
3 g	AWQ320231		2,65	-	-	-	
4 g	AWQ320232		2,65	-	-	-	
Trade Pack: x12				Trade Pack: x6			



ESCAUT			
Code	Weight	Gencod	RRP (€)
AWQ320212	2 g		2,55
AWQ320213	3 g		2,55
AWQ320214	4 g		2,55
AWQ320215	5 g		2,55
Trade Pack: x12 (Bulk)			



FARIO			
Code	Weight	Gencod	RRP (€)
123402051	3 g		2,75
123403051	4 g		2,75
123404051	5 g		2,75
Trade Pack: x12 (Bulk)			



GAVE			
Code	Weight	Gencod	RRP (€)
RG3200115	2 g		2,75
RG3200116	3 g		2,75
RG3200117	4 g		2,75
Trade Pack: x12 (Bulk)			



JUNON			
Code	Weight	Gencod	RRP (€)
103501111	2,5 g		2,55
103502112	4 g		2,55
103503113	6 g		2,55
103504114	8 g		2,55
Trade Pack: x12 (Bulk)			

# FLOATS TROUT



## SCARPE

Code	Weight	Gencod	RRP (€)
AWQ320223	3 g		2,65
AWQ320224	4 g		2,65
AWQ320225	5 g		2,65

Trade Pack: x12 (Bulk)



## TOULOUSAIN LEADED SPIRE

Code	Weight	Gencod	RRP (€)
AWQ320008	3 g		3,60
AWQ320009	4 g		3,60
AWQ320010	5 g		3,60
AWQ320011	6 g		3,60
AWQ320012	8 g		3,60

Trade Pack: x12 (Bulk)



## TOULOUSAIN ACE

Weight	Code	Gencod	RRP (€)	Code	Gencod	RRP (€)
		BULK		2 PER BAG		
0,15 g	102200220		1,85	-	-	-
0,3 g	AWQ320233		1,85	-	-	-
0,6 g	102201221		1,85	147201091		3,95
0,8 g	102202222		1,85	086702091		3,95
1 g	102203223		1,95	118603091		4,30
2 g	102204224		1,95	118704091		4,30
3 g	102205225		1,95	118805091		4,30
4 g	102206226		2,40	118906091		5,20
5 g	102207227		2,40	119007091		5,20
6 g	102217227		2,40	-	-	-
2 + 3 + 4 g	-	-	-	111645091		6,50

Trade Pack: x12

Trade Pack: x6

# FLOATS TROUT



TOULOUSAIN ECO SPLIT						
Weight	Code	Gencod	RRP (€)	Code	Gencod	RRP (€)
		BULK			2 PER BAG	
0,8 g	151603091		2,10	-	-	-
1 g	151604091		2,30	-	-	-
2 g	151605091		2,30	178605091		4,95
3 g	151606091		2,30	178706091		4,95
4 g	151607091		2,65	178807091		5,80
5 g	151608091		2,65	178908091		5,80
Trade Pack: x12				Trade Pack: x6		



TROUT						
Weight	Code	Gencod	RRP (€)	Code	Gencod	RRP (€)
		BULK			2 PER BAG	
3 g	120001081		2,55	119301091		5,65
4 g	120001181		2,55	347002091		5,65
5 g	120002081		2,55	119402091		5,65
6 g	120002181		2,55	347104091		5,65
7 g	120003081		2,55	119503091		5,65
Trade Pack: x12				Trade Pack: x6		



# FLOATS TROUT



TRUST						
Weight	Code	Gencod	RRP (€)	Code	Gencod	RRP (€)
BULK				2 PER BAG		
2,5 g	-	-	-	119601091		5,65
3 g	060002081		2,55	119702091		5,65
4 g	060003081		2,55	119803091		5,65
5 g	060003181		2,55	347204091		5,65
6 g	060004081		2,55	178404091		5,65
Trade Pack: x12				Trade Pack: x6		



TURSAN				
Code	Weight	Gencod	RRP (€)	
072001271	3 g		2,75	
072002271	5 g		2,75	
072003271	7 g		2,75	
Trade Pack: x12 (Bulk)				



KIWI			
Code	Weight	Gencod	RRP (€)
105201091	2,5 g		2,55
105202091	4 g		2,55
105203091	6 g		2,55
105204091	8 g		2,55
Trade Pack: x12 (Bulk)			



KIWI SPLIT						
Weight	Code	Gencod	RRP (€)	Code	Gencod	RRP (€)
BULK				2 PER BAG		
2,5 g	102901091		2,55	-	-	-
4 g	102902091		2,55	179102091		5,65
6 g	102903091		2,55	179203091		5,65
8 g	102904091		2,55	179304091		5,65
Trade Pack: x12				Trade Pack: x6		

# FLOATS TROUT



METEOR PAC						
Weight	Code	Gencod	RRP (€)	Code	Gencod	RRP (€)
		BULK			2 PER BAG	
0,6 g	101703113		1,95	-	-	-
1 g	101704114		1,95	179404091		4,30
1,3 g	-	-	-	127105091		4,30
2 g	101705125		2,20	AWQ330087		4,30
3 g	101706116		2,20	125206091		4,75
4 g	101707117		2,20	125307091		4,75
5 g	101708118		2,20	-	-	-
6 g	101709119		2,55	-	-	-
8 g	110701111		2,55	-	-	-
10 g	110702112		2,55	-	-	-

Trade Pack: x12

Trade Pack: x6



METEOR PAC SPLIT						
Weight	Code	Gencod	RRP (€)	Code	Gencod	RRP (€)
		BULK			2 PER BAG	
1,2 g	101803113		2,10	-	-	-
2 g	101804114		2,10	179504091		4,50
2,8 g	101805115		2,65	117305091		5,90
3,5 g	101806116		2,65	117406091		5,90
5 g	101807117		2,65	117507091		5,90
6 g	101808118		2,65	-	-	-
7 g	101809119		2,65	-	-	-

Trade Pack: x12

Trade Pack: x6



# FLOATS CORK TROUT FLOAT



## LAUSANNOIS CORK

Code	Weight	Gencod	RRP (€)
102420091	2 g		3,95
102430091	3 g		4,10
102440091	4 g		4,30

Trade Pack: x12 (Bulk)



## POIRE CORK

Code	Weight	Gencod	RRP (€)
101404114	1 g		2,25
101405115	1,5 g		2,45
101406116	2 g		3,15
101407117	3 g		3,45
101408118	4 g		3,45
101409119	5 g		3,55

Trade Pack: x12 (Bulk)



## TOULOUSAIN CORK SPLIT

Code	Weight	Gencod	RRP (€)
102206091	0,6 g		2,50
102208091	0,8 g		2,90
102210091	1 g		3,05
102215091	1,5 g		3,20
102220091	2 g		3,45
102230091	3 g		3,70
102240091	4 g		3,95
102250091	5 g		4,60
102260091	6 g		5,20

Trade Pack: x12 (Bulk)



## NICOISE CORK SPLIT

Code	Weight	Gencod	RRP (€)
100103113	1 g		2,55
100104114	2 g		3,05
100105115	3 g		3,15
100106116	4 g		3,25

Trade Pack: x12 (Bulk)



## POIRE CORK SPLIT

Code	Weight	Gencod	RRP (€)
101504114	1 g		2,40
101505115	1,5 g		2,55
101506116	2 g		3,60
101507117	3 g		3,75
101508118	4 g		3,75
101509119	5 g		3,80

Trade Pack: x12 (Bulk)



# FLOATS CORK TROUT FLOAT



TOULOUSAIN CORK						
Weight	Code	Gencod	RRP (€)	Code	Gencod	RRP (€)
		BULK			2 PER BAG	
0,1 g	AWQ320234		2,40	-	-	-
0,15 g	102101091		2,40	-	-	-
0,3 g	AWQ320235		2,40	-	-	-
0,6 g	102106091		2,50	407300091		5,60
0,8 g	102108091		2,50	-	-	-
1 g	102110091		2,90	407500091		6,30
1,5 g	102115091		3,10	-	-	-
2 g	102120091		3,20	407700091		7,00
3 g	102130091		3,60	407800091		7,50
4 g	102140091		3,80	407900091		7,85
5 g	102150091		4,00	408000091		8,20
6 g	102160091		4,55	-	-	-
7 g	102170091		5,10	-	-	-
			Trade Pack: x12	Trade Pack: x6		



# FLOATS PREDATORS



AIX			
Code	Weight	Gencod	RRP (€)
106902112	8 g		2,50
106903113	10 g		2,50
106904114	15 g		2,50
106905115	20 g		2,50
AWQ320352	30 g		2,70

Trade Pack: x12 (Bulk)



ALLIER			
Code	Weight	Gencod	RRP (€)
RG3200118	5 g		2,50
RG3200119	10 g		2,50
RG3200120	15 g		2,50
RG3200121	20 g		2,50

Trade Pack: x12 (Bulk)



ANJOU			
Code	Weight	Gencod	RRP (€)
100801111	4 g		2,50
100802112	6 g		2,50
100803113	8 g		2,50
100804114	10 g		2,50
100805115	15 g		2,50

Trade Pack: x12 (Bulk)



AUTIZE			
Code	Weight	Gencod	RRP (€)
100702141	6 g		4,05
100703141	8 g		4,05
100704141	10 g		4,05
100706141	15 g		4,05

Trade Pack: x12 (Bulk)



BLAISE			
Code	Weight	Gencod	RRP (€)
RG3200184	5 g		2,50
RG3200185	10 g		2,50
RG3200186	15 g		2,50
RG3200187	20 g		2,50

Trade Pack: x12 (Bulk)



BOULOGNE			
Code	Weight	Gencod	RRP (€)
101801271	5 g		2,50
101802271	10 g		2,50
101812271	15 g		2,50
101822271	20 g		2,50
AWQ320238	30 g		2,70
101804271	50 g		3,65
101805271	70 g		4,85

Trade Pack: x12 (Bulk)

# FLOATS PREDATORS



PIKE						
Weight	Code	Gencod	RRP (€)	Code	Gencod	RRP (€)
BULK				1 PER BAG		
3,5 g	152000091		2,50	-	-	-
5 g	152001091		2,50	-	-	-
8 g	AWQ320092		2,50	-	-	-
10 g	152002091		2,50	RG3200179		3,15
15 g	152003091		2,50	RG3200180		3,15
20 g	152004091		2,50	RG3200181		3,15
30 g	152005091		2,70	-	-	-
40 g	152006091		3,40	-	-	-
50 g	152007091		3,65	-	-	-

Trade Pack: x12

Trade Pack: x6



BOURNE			
Code	Weight	Gencod	RRP (€)
RG3200122	5 g		2,50
RG3200123	10 g		2,50
RG3200124	15 g		2,50
RG3200125	20 g		2,50

Trade Pack: x12 (Bulk)



CEZE			
Code	Weight	Gencod	RRP (€)
100900141	5 g		2,50
100903141	10 g		2,50
100908141	15 g		2,50
100906141	20 g		2,50

Trade Pack: x12 (Bulk)



CHERE			
Code	Weight	Gencod	RRP (€)
RG3200188	5 g		2,50
RG3200189	10 g		2,50
RG3200200	15 g		2,50
RG3200201	20 g		2,50

Trade Pack: x12 (Bulk)



# FLOATS PREDATORS



COISE						
Weight	Code	Gencod	RRP (€)	Code	Gencod	RRP (€)
BULK				1 PER BAG		
5 g	AWQ320252		2,50	-	-	-
8 g	AWQ320356		2,50	-	-	-
10 g	AWQ320253		2,50	AWQ330108		3,15
15 g	AWQ320254		2,50	-	-	-
20 g	AWQ320255		2,50	AWQ330109		3,15
30 g	AWQ320256		2,70	AWQ330110		3,35
40 g	AWQ320257		3,40	AWQ330111		3,15
Trade Pack: x12				Trade Pack: x6		



COSSON			
Code	Weight	Gencod	RRP (€)
RG3200145	5 g		2,50
RG3200146	10 g		2,50
RG3200147	15 g		2,50
RG3200148	20 g		2,50
Trade Pack: x12 (Bulk)			



DER						
Weight	Code	Gencod	RRP (€)	Code	Gencod	RRP (€)
BULK				1 PER BAG		
4 g	153301271		2,50	-	-	-
6 g	153302271		2,50	345800141		3,15
8 g	153303271		2,50	345900141		3,15
10 g	153304271		2,50	346000141		3,15
15 g	153305271		2,50	346100141		3,15
Trade Pack: x12				Trade Pack: x6		



DONAN			
Code	Weight	Gencod	RRP (€)
153403271	4 g		2,50
153404271	6 g		2,50
153405271	8 g		2,50
153406271	10 g		2,50
153407271	15 g		2,50
Trade Pack: x12 (Bulk)			

# FLOATS PREDATORS



DRAC			
Code	Weight	Gencod	RRP (€)
AWQ320240	7+1 g		3,40
AWQ320241	8+2 g		3,40
AWQ320242	10+2 g		4,05
AWQ320243	13+2 g		4,05

Trade Pack: x12 (Bulk)



DURGEON			
Code	Weight	Gencod	RRP (€)
RG3200149	5 g		2,50
RG3200150	10 g		2,50
RG3200151	15 g		2,50
RG3200152	20 g		2,50

Trade Pack: x12 (Bulk)



ESQUE			
Code	Weight	Gencod	RRP (€)
AWQ320361	8 g		2,50
AWQ320263	10 g		2,50
AWQ320264	15 g		2,50
AWQ320265	20 g		2,50
AWQ320266	30 g		2,70
AWQ320267	40 g		3,40

Trade Pack: x12 (Bulk)



ISCH							
Weight	Code	Gencod	RRP (€)	Code	Gencod	RRP (€)	
		BULK			1 PER BAG		
5 g	100301271		2,50	193301091		3,15	
8 g	100302271		2,50	-	-	-	
10 g	100303271		2,50	188902091		3,15	
15 g	100304271		2,50	159803091		3,15	
20 g	100305271		2,50	160005091		3,15	
30 g	100306271		2,70	167506091		3,35	
40 g	100307271		3,40	018007091		4,05	
50 g	AWQ320189		3,65	-	-	-	

Trade Pack: x12

Trade Pack: x6



FRENCH			
Code	Weight	Gencod	RRP (€)
080002081	8 g		2,50
080003081	10 g		2,50
080004081	15 g		2,50
080005081	20 g		2,50

Trade Pack: x12 (Bulk)

# FLOATS PREDATORS



KOUROU						
Weight	Code	Gencod	RRP (€)	Code	Gencod	RRP (€)
BULK				1 PER BAG		
5 g	FCKOU0501		2,50	-	-	-
10 g	FCKOU1001		2,50	FCKOU10B1		3,15
15 g	FCKOU1501		2,50	FCKOU15B1		3,15
20 g	FCKOU2001		2,50	FCKOU20B1		3,15
30 g	FCKOU3001		2,70	FCKOU30B1		3,35
Trade Pack: x12				Trade Pack: x6		



LIZAINE			
Code	Weight	Gencod	RRP (€)
111100271	5 g		2,50
RG3200157	8 g		2,50
111101271	10 g		2,50
111102271	15 g		2,50
111103271	20 g		2,50
111104271	30 g		2,70
Trade Pack: x12 (Bulk)			



LOING			
Code	Weight	Gencod	RRP (€)
AWQ320281	10 g		2,50
AWQ320282	15 g		2,50
AWQ320283	20 g		2,50
AWQ320284	25 g		2,50
Trade Pack: x12 (Bulk)			



MADON			
Code	Weight	Gencod	RRP (€)
AWQ320285	10 g		2,50
AWQ320286	15 g		2,50
AWQ320287	20 g		2,50
AWQ320288	25 g		2,50
AWQ320289	30 g		2,70
Trade Pack: x12 (Bulk)			



ORNE			
Code	Weight	Gencod	RRP (€)
RG3200202	5 g		2,50
RG3200203	10 g		2,50
RG3200204	15 g		2,50
RG3200205	20 g		2,50
Trade Pack: x12 (Bulk)			

# FLOATS PREDATORS



SEILLE						
Weight	Code	Gencod	RRP (€)	Code	Gencod	RRP (€)
BULK				1 PER BAG		
5 g	106201141		2,50	-	-	-
8 g	AWQ320363		2,50	-	-	-
10 g	106202141		2,50	AWQ330001		3,15
15 g	106203141		2,50	AWQ330002		3,15
20 g	106204141		2,50	AWQ330003		3,15
30 g	106205141		2,70	-	-	-
Trade Pack: x12				Trade Pack: x6		



SOMME			
Code	Weight	Gencod	RRP (€)
108902141	10 g		2,50
108903141	15 g		2,50
108904141	20 g		2,50
Trade Pack: x12 (Bulk)			



SIFFLET						
Weight	Code	Gencod	RRP (€)	Code	Gencod	RRP (€)
BULK				1 PER BAG		
6 g	122301051		2,50	038560051		3,15
8 g	RG3200158		2,50	RG3200182		3,15
10 g	122302051		2,50	038660091		3,15
15 g	122303051		2,50	038760091		3,15
20 g	122304051		2,50	105660091		3,15
30 g	122305051		2,70	105760091		3,35
Trade Pack: x12				Trade Pack: x6		



VOUGLAN			
Code	Weight	Gencod	RRP (€)
102602112	5 g		2,50
102603113	7 g		2,50
102604114	10 g		2,50
102605115	15 g		2,50
102606116	20 g		2,50
102607117	30 g		2,70
Trade Pack: x12 (Bulk)			



# FLOATS BULDO



## BALL FLOAT - LOADING

Model	Code	Gencod	RRP (€)	Code	Gencod	RRP (€)
		Cristal			Red	
Ø 25 mm - 8 g	AB0000100		1,60	AB0001100		1,60
Ø 30 mm - 15 g	AB0000200		1,70	AB0001200		1,70
Ø 40 mm - 30 g	AB0000300		2,10	AB0001300		2,10
Ø 45 mm - 40 g	AB0000400		2,55	AB0001400		2,55

Trade Pack: x10 (Bulk)

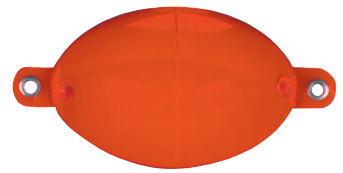

## BALL FLOAT - OVAL LOADING

Model	Code	Gencod	RRP (€)	Code	Gencod	RRP (€)
		Cristal			Red	
Ø 23 mm - 8 g	AB0007100		1,50	-	-	-
Ø 28 mm - 15 g	AB0007200		1,70	AB0008200		1,70
Ø 35 mm - 30 g	AB0007300		2,10	AB0008300		2,10
Ø 40 mm - 40 g	AB0007400		2,55	AB0008400		2,55
Ø 45 mm - 60 g	AB0007500		3,50	AB0008500		3,50
Ø 50 mm - 80 g	RG3200096		4,00	AB0008600		4,00

Trade Pack: x10 (Bulk)

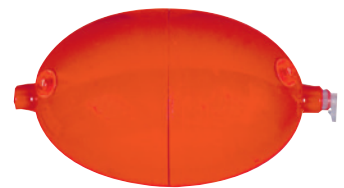

## BALL FLOAT - ADJUSTABLE OVAL LOADING

Model	Code	Gencod	RRP (€)	Code	Gencod	RRP (€)	Code	Gencod	RRP (€)
		White/Red			Cristal			Red	
Ø 23 mm - 8 g	AB0006100		2,35	AB0004100		2,00	AB0005100		2,00
Ø 28 mm - 15 g	AB0006200		2,55	AB0004200		2,25	AB0005200		2,25
Ø 35 mm - 30 g	AB0006300		2,75	AB0004300		2,65	AB0005300		2,65
Ø 40 mm - 40 g	AB0006400		2,95	AB0004400		2,75	-	-	-

Trade Pack: x10 (Bulk)



## FLEXIBULL

Code	Ø	Weight	Gencod	RRP (€)
RG3200097	24 mm	8 g		1,80
RG3200098	30 mm	14 g		1,90

Trade Pack: x10 (Bulk)

# FLOATS SEA



BALL FLOAT - SPLIT BC						
Weight	Code	Gencod	RRP (€)	Code	Gencod	RRP (€)
BULK				2 PER BAG		
1 g	FBNFB0200		1,85	FBNFB02B0		4,30
2 g	FBNFB0300		1,85	FBNFB03B0		4,30
3 g	FBNFB0400		1,85	FBNFB04B0		4,30
4 g	FBNFB0500		2,20	-	-	-
5 g	FBNFB0600		2,20	-	-	-
6 g	FBNFB0700		2,20	-	-	-
8 g	FBNFB0800		2,20	-	-	-
10 g	FBNFB0900		2,20	-	-	-
Trade Pack: x12				Trade Pack: x6		



LUBINA TALLA			
Code	Weight	Gencod	RRP (€)
RG3200190	20 g		3,15
RG3200191	25 g		3,25
RG3200192	30 g		3,25
RG3200193	35 g		3,80
RG3200194	40 g		3,80
RG3200195	50 g		4,25
RG3200196	60 g		4,70
Trade Pack: x12 (Bulk)			



ESPIGNOL			
Code	Weight	Gencod	RRP (€)
FMESP0402	4 g		2,45
FMESP0603	6 g		2,45
FMESP0804	8 g		2,45
FMESP1005	10 g		2,45
Trade Pack: x12 (Bulk)			

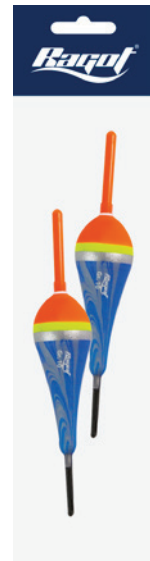

CAGNE						
Weight	Code	Gencod	RRP (€)	Code	Gencod	RRP (€)
BULK				2 PER BAG		
4 g	FMCAG0402		2,45	FMCAG04B2		5,10
6 g	FMCAG0603		2,45	-	-	-
8 g	FMCAG0804		2,45	-	-	-
Trade Pack: x12				Trade Pack: x6		

# FLOATS SEA



## EVA FLOAT

Code	Weight	Gencod	RRP (€)
18BFEVA02	02-15 g		3,90
18BFEVA03	03-25 g		3,95
18BFEVA04	04-30 g		4,60
18BFEVA05	05-40 g		5,10
18BFEVA06	06-60 g		5,55

Trade Pack: x6 (1 per Blister)



- Electric float for use with a lithium battery (not supplied).
- Gasket.

## ELECTRIC FLOAT

Code	Weight	Gencod	RRP (€)
ATO330013	10 g		11,30
RG3200173	15 g		11,30
ATO330015	20 g		11,30

Trade Pack: x5 (1 per Bag)



Crystal tube designed to receive a Starlite SL-4 or SL-5 (10g model) or SL-1 (15 and 20g models).

## LUMINOUS FLOAT NARROW

Code	Weight	Gencod	RRP (€)
FLE015000	15 g		5,75

Trade Pack: x6 (1 per Bag)



Crystal tube designed to receive a Starlite SL-1.

## LUMINOUS FLOAT LARGE

Code	Weight	Gencod	RRP (€)
FLL020000	20 g		5,75
FLL030000	30 g		5,75

Trade Pack: x6 (1 per Bag)

# FLOATS SEA



- Pre-loaded float
- Can be used as fixed or sliding
- Includes plastic antenna in 4,5 mm
- Can hold a starlite in 4,5 mm

SEALIGHT				
Code	Weight	Gencod	RRP (€)	
RG3300001	10+10 g		5,65	
RG3300002	20+10 g		6,10	
RG3300003	20+20 g		6,50	
RG3300004	30+20 g		7,00	

Trade Pack: x6 (1 per packet)



- Two versions available:
- Inline version complete with an inner wire for a better control of the line.
  - Sliding version, attached from the base, for longer casting.
- Features include:
- Special design for float fishing in the sea.
  - High visibility during the day due to the white body & coloured head.
  - Very visible at night due to the illuminated heads (supplied with two colour options).
  - Works with a CR-2032 battery (supplied with the float).

RAGFLASH			
Code	Weight	Gencod	RRP (€)
RG3200178	20 g		12,50

Trade Pack: x5 (1 per Bag)

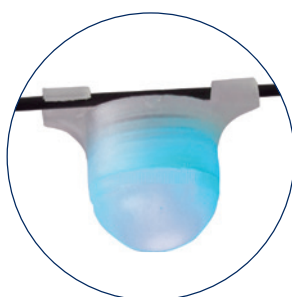

Instructions for use: Connect the detector at the tip of the rod. The green light will flash once it is in place. When a bite is detected the diode changes to blue. Remove the detector at the end of the fishing trip.

- Features:
- Lifetime of about 1000 hours
  - Visible up to 65m (in good conditions)
  - Waterproof
  - Supplied with 1 CR1225 3 V battery

AUTO LIGHT BLUE		
Code	Gencod	RRP (€)
ATO030002		13,50

Trade Pack: x10



Thanks to its aerodynamic shape, the indestructible Ballrag® bounces safely on the rocks and propels the lures at a great distance to a precise location. Floating model

BALLRAG®			
Code	Weight	Gencod	RRP (€)
RG3251134	40 g		6,70
RG3251136	60 g		7,60
RG3251164	40 g		6,35
RG3251166	60 g		7,30

Trade Pack: x6



Allows you to use a Starlite SL-1 or SL-2.

PORTE STARLITE			
Code	Size	Gencod	RRP (€)
APS000100	Small x2		2,20
APS000200	Large x2		2,20

Trade Pack: x10 (2 per Bag)



LED lights for night fishing, cork fishing, eging, etc. Includes long life battery for each light. Colors red or green, also pack with 2 batteries.

LIGHT+ BATTERY			
Code	Color	Gencod	RRP (€)
RG3200174	Green		4,50
RG3200175	Red		4,50

Trade Pack: x6 (1 per Bag)



- BR-435- 3 V batteries
- Compatible with our electric floats

LITHIUM ECO BATTERY		
Code	Gencod	RRP (€)
ATO010035		4,50

Trade Pack: x10 (x2)



# CLIPLIGHT / STARLITE



CLIPLIGHT				
Code	Size	Specifications	Gencod	RRP (€)
AA0032050	1,4 to 1,7 mm	S		1,25
AA0032100	1,8 to 2,3 mm	M		1,15
AA0032200	2,4 to 2,9 mm	L		1,15
AA0032300	3 to 3,5 mm	XL		1,15
AA0033000	3,6 to 4,1 mm	XXL		1,15

Trade Pack: x50 (1 per Bag)



STARLITE				
Code	Size	Specifications	Gencod	RRP (€)
ATO010004	∅ 2,2 x 22 mm	-		2,30
AA0031100	∅ 4,5 x 37 mm	SL-1		0,80
AA0031200	∅ 4,5 x 37 mm	SL-2		0,80
AA0031300	∅ 6,0 x 50 mm	SL-3		0,95
AA0031500	∅ 2,9 x 50 mm	SL-4		0,85
AA0031600	∅ 3,0 x 25 mm	SL-5		0,85
AA0032000	∅ 7,5 x 75 mm	SL-75		1,50
AA0032001	∅ 4,5 x 42 mm	SL 1+2		1,00
AA0032004	∅ 4,5-8,0 x 30 mm	SL 11		1,15

Trade Pack: x50 (3 per Bag)



STARLITE				
Code	Size	Specifications	Gencod	RRP (€)
AA0032003	∅ 6,0 x 50 mm	SL 3		2,85

Trade Pack: x25 (6 per Bag)



STARLITE				
Code	Size	Specifications	Gencod	RRP (€)
AA0032002	∅ 4,5 x 42 mm	SL 1+2		3,05

Trade Pack: x25 (10 per Bag)

# FLOATS KITS



Brighton 4 + 1 - Picollo 5 + 1 -  
London 6 + 2 g

### LEADED MATCH FLOAT KIT x3

Code	Gencod	RRP (€)
AWQ330016		14,20

Trade Pack: x6 (3 per Bag)



Ouere 0,80 - Briance 0,60 - Drou 0,40 g

### 3 FLOAT KIT FOR CANAL AND LAKE

Code	Gencod	RRP (€)
AWQ330017		6,45

Trade Pack: x6 (3 per Bag)



Orbize 2,00 - Ognon 1,50 - Lignon 1,00 g

### 3 FLOAT KIT FOR RIVER

Code	Gencod	RRP (€)
AWQ330018		6,45

Trade Pack: x6 (3 per Bag)



Floppy 1,00 - Versailles 0,60 - Zoom 1,50 g

### 3 FLOAT KIT FOR PLEASURE FISHING

Code	Gencod	RRP (€)
AWQ330024		5,45

Trade Pack: x6 (3 per Bag)



Diving 6,00 - Floating 15,00 - Half Depth  
10,00 g

### 3 FLOAT KIT SURFACE FLOATS

Code	Gencod	RRP (€)
AWQ330019		10,80

Trade Pack: x6 (3 per Bag)



Floating 15,00 - Half Depth 10,00 - Diving  
15,00 g

### 3 FLOAT KIT SURFACE FLOATS TRANSPARENT

Code	Gencod	RRP (€)
AWQ330020		9,90

Trade Pack: x6 (3 per Bag)



Api 4,00 - Trout 3,00 - Toulouse ACE 2,00 g

### TROUT FLOAT KIT x3

Code	Gencod	RRP (€)
AWQ330021		5,45

Trade Pack: x6 (3 per Bag)



Kiwi 4,00 - Cerou 3,00 - Meteor PAC 2,00 g

### PEAR TROUT FLOAT KIT x3

Code	Gencod	RRP (€)
AWQ330022		5,45

Trade Pack: x6 (3 per Bag)



Cerou 4,00 - 6,00 - 8,00 g

### PEAR FLOAT KIT x3

Code	Gencod	RRP (€)
AWQ330290		6,45

Trade Pack: x6 (3 per Bag)

# FLOATS KITS



Cerou Split 2,00 - 3,00 - 4,00 g

### PEAR FLOAT SPLIT KIT x3

Code	Gencod	RRP (€)
AWQ330291		6,70

Trade Pack: x6 (3 per Bag)



Kiwi split 2,50 - Toulousain ECO split 4,00 - Meteor PAC cracked 3,50 g

### PEAR TROUT FLOAT SPLIT KIT x3

Code	Gencod	RRP (€)
AWQ330023		6,45

Trade Pack: x6 (3 per Bag)



Api 0,4 - Meteor Pac 0,3 + 0,6 - Toulousain ACE 0,6 + 0,8 g

### TROUT KIT x4 + 1 FREE

Code	Gencod	RRP (€)
110100091		8,00

Trade Pack: x6 (4 per Bag + 1 Free)



Pike 5,00 - 8,00 - 10,00 g

### KIT 3 FLOATS PREDATOR SMALL

Code	Gencod	RRP (€)
AWQ330078		7,35

Trade Pack: x6 (3 per Bag)



Pike 10,00 - 15,00 - 20,00 g

### KIT 3 FLOATS PREDATOR LARGE

Code	Gencod	RRP (€)
AWQ330079		7,70

Trade Pack: x6 (3 per Bag)



Coise 5,00 - Loing 10,00 - Esque 15,00 g

### KIT 3 FLOATS PREDATOR

Code	Gencod	RRP (€)
AWQ330178		7,35

Trade Pack: x6 (3 per Bag)



Madon 10,00 - Furan 15,00 - Viaur 20,00 g

### KIT 3 FLOATS PREDATOR

Code	Gencod	RRP (€)
AWQ330179		7,70

Trade Pack: x6 (3 per Bag)



Esque 15,00 - Coise 20,00 - Isch 30,00 g

### KIT 3 FLOATS PREDATOR

Code	Gencod	RRP (€)
RG3200183		8,50

Trade Pack: x6 (3 per Blister)

# LEADS



**SPLIT SHOT DISPENSER x 4**

Size	Composition	Code	BULK		1 PER BLISTER	
			Gencod	RRP (€)	Code	RRP (€)
Small	0,012 - 0,03 - 0,06 - 0,12 g	142000211		5,30	-	-
Medium	0,12 - 0,18 - 0,28 - 0,48 g	134000211		5,30	075110211	7,30
Large	0,36 - 0,48 - 0,7 - 0,77 g	141000211		5,30	121311211	7,30

Trade Pack: x10

Trade Pack: x10



**SPLIT SHOT DISPENSER x 6**

Size	Composition	Code	BULK		1 PER BLISTER	
			Gencod	RRP (€)	Code	RRP (€)
Small	0,012 - 0,02 - 0,03 - 0,04 - 0,06 - 0,09 g	130000211		6,60	-	-
Medium	0,04 - 0,06 - 0,09 - 0,12 - 0,14 - 0,18 g	131000211		6,60	010600211	8,45
Large	0,24 - 0,28 - 0,36 - 0,48 - 0,7 - 0,77 g	132000211		6,60	010700211	8,45
Very Large	0,36 - 0,48 - 0,77 - 0,94 - 1,23 - 1,80 g	RG5521001		6,60	-	-

Trade Pack: x10

Trade Pack: x10



**MATCH SPLIT SHOT DISPENSER x 6**

Size	Composition	Code	BULK		1 PER BLISTER	
			Gencod	RRP (€)	Code	RRP (€)
N°1 - BB - AAA - SSG - 8 - 4	0,06 - 0,18 - 0,28 - 0,36 - 0,77 et 2 g	131000213		7,05	010500213	8,90

Trade Pack: x10

Trade Pack: x10



# LEADS



## PRACTICAL SPLIT SHOT DISPENSER x 6

Size	Composition	Code	Gencod	RRP (€)	Code	Gencod	RRP (€)
		BULK			1 PER BLISTER		
N°BB - 3/0 - 7 - 5 - 4	0,5 - 1 - 2 - 2,5 and 3 g	112600211		8,45	123000211		11,20
				Trade Pack: x10			
					Trade Pack: x10		



## SPLIT SHOT DISPENSER x 5

Ø	Composition	Code	Gencod	RRP (€)
		BULK		
10 - 9 - 12,50 - 12 - 11	4,15 - 5,5 - 8,3 - 10 and 12 g	123310211		14,10
Trade Pack: x10				



Soft Weights, regular and very well centered.

## SPLIT SHOT BOXES

Code	Ø	Weight	N°	Gencod	RRP (€)	Code	Ø	Weight	N°	Gencod	RRP (€)
892016211	6,80 mm	1,77 g	SSG-8/0		3,35	879003211	3,30 mm	0,221 g	3		3,35
135000222	6,20 mm	1,56 g	7/0		3,35	880004211	3,10 mm	0,177 g	4		3,35
135100221	5,60 mm	1,18 g	SG-6/0		3,35	881005211	2,90 mm	0,135 g	5		3,35
135200221	5 mm	0,69 g	AAA-5/0		3,35	882006211	2,70 mm	0,112 g	6		3,35
890014211	4,50 mm	0,68 g	4/0		3,35	883007211	2,50 mm	0,088 g	7		3,35
135300221	4,30 mm	0,47 g	3/0		3,35	884008211	2,30 mm	0,07 g	8		3,35
891015211	3,90 mm	0,39 g	BB-0		3,35	885009211	2,10 mm	0,056 g	9		3,35
877001211	3,70 mm	0,295 g	1		3,35	886010211	1,90 mm	0,040 g	10		3,35
878002211	3,50 mm	0,271 g	2		3,35						

Trade Pack: x6

Trade Pack: x6

# LEADS



## ARLESEY BLISTER

Code	Weight	Quantity	Gencod	RRP (€)
013710211	7 g	10 per Blister		7,70
013810211	10 g	8 per Blister		7,70
013910211	15 g	8 per Blister		8,30
014010211	20 g	6 per Blister		8,30
021010211	30 g	5 per Blister		8,30
021110211	40 g	4 per Blister		8,30
021210211	50 g	3 per Blister		8,30
021310211	60 g	3 per Blister		8,30

Trade Pack: x10



## SPLIT SHOT BLISTER

Code	Weight	Quantity	Gencod	RRP (€)
AWQ550002	0,5 g	30 per Blister		3,00
154100221	0,75 g	20 per Blister		3,00
113500211	1 g	20 per Blister		3,25
113600211	1,5 g	20 per Blister		3,60
113700211	2 g	20 per Blister		4,15
112700211	3 g	20 per Blister		4,85
112800211	4 g	15 per Blister		4,85
112900211	6 g	15 per Blister		6,25
113000211	8 g	12 per Blister		6,45
113100211	10 g	12 per Blister		7,50

Trade Pack: x10



## CLIP ON PLUMMET BLISTER

Code	Weight	Quantity	Gencod	RRP (€)
121410211	5 g	2 per Blister		7,40
086810211	10 g	2 per Blister		7,65
086910211	15 g	2 per Blister		8,00
100510211	25 g	2 per Blister		8,90

Trade Pack: x10



## HEXAGONAL WEIGHTS BLISTER

Code	Weight	Quantity	Gencod	RRP (€)
023610211	20 g	8 per Blister		5,30
018510211	30 g	6 per Blister		5,30
023710211	40 g	4 per Blister		5,30
023810211	50 g	3 per Blister		5,30
023910211	60 g	3 per Blister		5,30
025410211	75 g	2 per Blister		5,30
025510211	100 g	2 per Blister		5,30

Trade Pack: x10



## OLIVE LARGE BLISTER

Code	Weight	Quantity	Gencod	RRP (€)
075410211	3 g	20 per Blister		5,00
007310211	5 g	10 per Blister		5,00
007410211	7 g	10 per Blister		5,00
018010211	10 g	10 per Blister		5,00
116800211	15 g	8 per Blister		5,00
116900211	20 g	8 per Blister		5,00

Trade Pack: x10

# LEADS



OLIVETTE WEIGHT									
Weight	Code	Quantity	Gencod	RRP (€)	Code	Quantity	Gencod	RRP (€)	
BULK					BLISTER				
2,5 g	-	-	-	-	116700211	20 per Blister		4,70	
4 g	-	-	-	-	075510211	20 per Blister		4,70	
6 g	-	-	-	-	075610211	20 per Blister		4,70	
8 g	-	-	-	-	080910211	10 per Blister		4,70	
10 g	115500211	100 per Bag		25,35	016510211	10 per Blister		4,70	
15 g	115600211	50 per packet		19,55	075210211	8 per Blister		4,70	
20 g	115700211	50 per packet		26,00	016410211	8 per Blister		5,65	
30 g	115900211	50 per packet		35,15	016710211	6 per Blister		5,65	
40 g	-	-	-	-	016910211	4 per Blister		5,65	
50 g	-	-	-	-	027210211	4 per Blister		6,35	
60 g	-	-	-	-	027310211	3 per Blister		6,35	
75 g	-	-	-	-	027710211	3 per Blister		6,85	
100 g	-	-	-	-	027510211	2 per Blister		6,85	
Trade Pack: x1					Trade Pack: x10				



LONGLINE BRASS RING									
Weight	Code	Quantity	Gencod	RRP (€)	Code	Quantity	Gencod	RRP (€)	
BULK					BLISTER				
30 g	PAL003000	10 per Bag		14,25	-	-	-	-	
40 g	PAL004000	10 per Bag		17,05	PAL0040B0	2 per Blister		4,90	
50 g	PAL005000	10 per Bag		20,80	PAL0050B0	2 per Blister		5,30	
60 g	PAL006000	10 per Bag		25,90	PAL0060B0	2 per Blister		6,55	
80 g	PAL008000	10 per Bag		28,50	PAL0080B0	2 per Blister		7,20	
100 g	PAL010000	10 per Bag		31,75	PAL0100B0	2 per Blister		7,70	
120 g	PAL012000	10 per Bag		35,05	PAL0120B0	2 per Blister		7,90	
150 g	PAL015000	10 per Bag		38,40	-	-	-	-	
200 g	PAL020000	10 per Bag		43,90	-	-	-	-	
Trade Pack: x1					Trade Pack: x10				



Multi-purpose sea fishing lead that can be used for legering or vertical fishing.

#### OLIVE LARGE + SWIVEL BULK

Code	Weight	Gencod	RRP (€)
RG5521015	20 g		9,45
RG5521016	30 g		11,55
RG5521017	40 g		13,65
RG5521018	50 g		15,75
RG5521019	60 g		18,00

Trade Pack: x1 (10 per Bag)



Special shape for sea fishing and mainly surf-casting. Designed not to grip and to roam the seabed dragging the bait with it.

#### PORTUGUESE LEAD BULK

Code	Weight	Gencod	RRP (€)
RG5521008	80 g		28,35
RG5521009	100 g		32,55
RG5521010	120 g		37,80
RG5521011	150 g		43,05
RG5521012	170 g		49,35

Trade Pack: x1 (10 per Bag)



#### RELEASE WEIGHT BULK

Code	Weight	Gencod	RRP (€)
DEX010000	100 g		51,15
DEX012500	125 g		55,35
DEX015000	150 g		59,90
DEX017500	175 g		64,70

Trade Pack: x1 (10 per Bag)



#### BRASS WEIGHT FRAME BULK

Code	Weight	Gencod	RRP (€)
GRA010000	100 g		42,75
GRA012000	120 g		54,80
GRA015000	150 g		60,30

Trade Pack: x1 (10 per Bag)



LB : 7 m - ET : 20 cm



L1				
Code	N°H	Weight	Gencod	RRP (€)
RG8200002	20	0,6 g		4,90
RG8200003	18	0,8 g		4,90
RG8200004	16	1 g		4,90

Trade Pack: x6 (Bulk)



L2				
Code	N°H	Weight	Gencod	RRP (€)
RG8200005	20	0,6 g		4,90
RG8200006	18	0,8 g		4,90
RG8200007	16	1 g		4,90

Trade Pack: x6 (Bulk)



L3				
Code	N°H	Weight	Gencod	RRP (€)
RG8200008	20	0,6 g		4,90
RG8200009	18	0,8 g		4,90
RG8200010	16	1 g		4,90

Trade Pack: x6 (Bulk)



L5				
Code	N°H	Weight	Gencod	RRP (€)
RG8200011	20	0,8 g		4,90
RG8200012	18	1 g		4,90
RG8200013	16	1,5 g		4,90

Trade Pack: x6 (Bulk)



ABL0UX				
Code	N°H	Weight	Gencod	RRP (€)
206800141	18	1 g		4,40
206900141	16	1,5 g		4,40

Trade Pack: x6 (Bulk)



ANDLAU				
Code	N°H	Weight	Gencod	RRP (€)
052212281	22	0,4 g		4,40
052012281	20	0,6 g		4,40
051812281	18	0,8 g		4,40

Trade Pack: x6 (Bulk)

LB : 7 m - ET : 20 cm



ANGLIN				
Code	N°H	Weight	Gencod	RRP (€)
642011141	20	0,6 g		4,40
641811141	18	0,8 g		4,40

Trade Pack: x6 (Bulk)



BEUVE				
Code	N°H	Weight	Gencod	RRP (€)
832041141	20	0,6 g		4,40
831811141	18	0,8 g		4,40
831611141	16	1 g		4,40
831411141	14	1,5 g		4,40

Trade Pack: x6 (Bulk)



BLAVET				
Code	N°H	Weight	Gencod	RRP (€)
AWQ821216	20	0,8 g		4,40
AWQ821217	18	1 g		4,40
AWQ820069	16	1 g		4,40

Trade Pack: x6 (Bulk)



BORNE				
Code	N°H	Weight	Gencod	RRP (€)
207000141	20	0,8 g		4,40
207100141	18	1 g		4,40
207200141	16	1,5 g		4,40

Trade Pack: x6 (Bulk)



BRAGUE				
Code	N°H	Weight	Gencod	RRP (€)
072011141	20	0,6 g		4,40
071811141	18	0,8 g		4,40
071611141	16	1 g		4,40

Trade Pack: x6 (Bulk)



BRIANCE				
Code	N°H	Weight	Gencod	RRP (€)
822211141	22	0,3 g		4,40
822011141	20	0,4 g		4,40
821811141	18	0,6 g		4,40
821611141	16	0,8 g		4,40

Trade Pack: x6 (Bulk)

LB : 7 m - ET : 20 cm



### CORBIONNE

Code	N°H	Weight	Gencod	RRP (€)
272221281	22	0,4 g		4,40
272021281	20	0,6 g		4,40
271821281	18	0,8 g		4,40
271621281	16	1 g		4,40

Trade Pack: x6 (Bulk)



### DESSOUBRE

Code	N°H	Weight	Gencod	RRP (€)
530181281	18	0,7 g		4,40
530161281	16	1 g		4,40
530141281	14	1,5 g		4,40

Trade Pack: x6 (Bulk)



### DROU

Code	N°H	Weight	Gencod	RRP (€)
128201141	20	0,4 g		4,40
128181141	18	0,6 g		4,40
128161141	16	0,8 g		4,40
128141141	14	1 g		4,40

Trade Pack: x6 (Bulk)



### FAVE

Code	N°H	Weight	Gencod	RRP (€)
RG8200000	22	0,2 g		4,40
112032281	20	0,4 g		4,40
111812281	18	0,6 g		4,40
111612281	16	0,6 g		4,40

Trade Pack: x6 (Bulk)



### GARDON

Code	N°H	Weight	Gencod	RRP (€)
531202281	20	0,4 g		4,40
531181281	18	0,6 g		4,40
531161281	16	0,8 g		4,40
531141281	14	1 g		4,40

Trade Pack: x6 (Bulk)



### GERVANNE

Code	N°H	Weight	Gencod	RRP (€)
114221141	22	0,8 g		4,40
114201141	20	1 g		4,40
114181141	18	1,25 g		4,40
114161141	16	1,5 g		4,40

Trade Pack: x6 (Bulk)

LB : 7 m - ET : 20 cm



GRISON				
Code	N°H	Weight	Gencod	RRP (€)
AWQ820030	22	0,2 g		4,40
942011141	20	0,2 g		4,40
941811141	18	0,3 g		4,40
941611141	16	0,4 g		4,40

Trade Pack: x6 (Bulk)



GROSNE				
Code	N°H	Weight	Gencod	RRP (€)
124201141	20	0,6 g		4,40
124181141	18	0,8 g		4,40
124161141	16	1 g		4,40

Trade Pack: x6 (Bulk)



HOUSTON				
Code	N°H	Weight	Gencod	RRP (€)
125201141	20	0,6 g		4,40
125181141	18	0,8 g		4,40
125161141	16	0,8 g		4,40

Trade Pack: x6 (Bulk)



JUINE				
Code	N°H	Weight	Gencod	RRP (€)
105211141	20	0,6 g		4,40
105181141	18	0,8 g		4,40
105161141	16	1 g		4,40

Trade Pack: x6 (Bulk)



LIGNON				
Code	N°H	Weight	Gencod	RRP (€)
736201141	20	0,6 g		4,40
735181141	18	0,8 g		4,40
734161141	16	1 g		4,40
733141141	14	1,5 g		4,40

Trade Pack: x6 (Bulk)



MODER				
Code	N°H	Weight	Gencod	RRP (€)
222012281	20	0,4 g		4,40
221812281	18	0,6 g		4,40
221612281	16	0,8 g		4,40

Trade Pack: x6 (Bulk)

LB : 7 m - ET : 20 cm



MUSSY				
Code	N°H	Weight	Gencod	RRP (€)
739201141	20	0,4 g		4,40
738181141	18	0,6 g		4,40
737161141	16	0,8 g		4,40

Trade Pack: x6 (Bulk)



OGNON				
Code	N°H	Weight	Gencod	RRP (€)
207300141	20	0,8 g		4,40
207400141	18	1 g		4,40
207500141	16	1,5 g		4,40

Trade Pack: x6 (Bulk)



ORBIZE				
Code	N°H	Weight	Gencod	RRP (€)
745181141	18	0,8 g		4,40
744161141	16	1 g		4,40
743141141	14	1,5 g		4,40
742121141	12	2 g		4,40
741101141	10	3 g		4,40

Trade Pack: x6 (Bulk)



OTHAIN				
Code	N°H	Weight	Gencod	RRP (€)
507221281	22	0,4 g		4,40
507201281	20	0,6 g		4,40
507181281	18	0,8 g		4,40

Trade Pack: x6 (Bulk)



OUERE				
Code	N°H	Weight	Gencod	RRP (€)
042011141	20	0,3 g		4,40
041811141	18	0,4 g		4,40
041611141	16	0,6 g		4,40

Trade Pack: x6 (Bulk)



RODE				
Code	N°H	Weight	Gencod	RRP (€)
749201141	20	0,4 g		4,40
748181141	18	0,6 g		4,40
747161141	16	0,8 g		4,40

Trade Pack: x6 (Bulk)



# RIGS FINESSE

LB : 7 m - ET : 20 cm



TAMIGI				
Code	N°H	Weight	Gencod	RRP (€)
122201141	20	0,4 g		4,40
122181141	18	0,6 g		4,40
122161141	16	0,8 g		4,40

Trade Pack: x6 (Bulk)



THALIE				
Code	N°H	Weight	Gencod	RRP (€)
127201141	20	0,4 g		4,40
127181141	18	0,6 g		4,40
127161141	16	0,8 g		4,40

Trade Pack: x6 (Bulk)



VIERES				
Code	N°H	Weight	Gencod	RRP (€)
AWQ820052	20	0,4 g		4,40
AWQ820053	18	0,6 g		4,40
AWQ820054	16	0,8 g		4,40

Trade Pack: x6 (Bulk)

# RIGS CARP

LB : 22 m - ET : 20 cm



CARPE 1				
Code	N°H	Weight	Gencod	RRP (€)
AWQ820045	12	0,8 g		4,90
AWQ820046	10	1 g		4,90

Trade Pack: x6 (Bulk)



CARPE 3				
Code	N°H	Weight	Gencod	RRP (€)
AWQ820047	12	0,8 g		4,90
AWQ820048	10	1 g		4,90

Trade Pack: x6 (Bulk)

LB : 7 m - ET : 20 cm



CLUB				
Code	N°H	Weight	Gencod	RRP (€)
252033281	20	0,5 g		3,95
251811281	18	0,8 g		3,95
251611281	16	1,5 g		3,95

Trade Pack: x6 (Bulk)



CORVETTE				
Code	N°H	Weight	Gencod	RRP (€)
192011281	20	0,1 g		3,95
191811281	18	0,2 g		3,95
191611281	16	0,3 g		3,95

Trade Pack: x6 (Bulk)



ETOILE				
Code	N°H	Weight	Gencod	RRP (€)
202011141	20	0,2 g		3,95
201811141	18	0,3 g		3,95
201611141	16	0,3 g		3,95
201411141	14	0,7 g		3,95

Trade Pack: x6 (Bulk)



FLOPPY				
Code	N°H	Weight	Gencod	RRP (€)
232011421	20	0,55 g		3,95
231811421	18	0,55 g		3,95
231611421	16	1 g		3,95

Trade Pack: x6 (Bulk)



KILT				
Code	N°H	Weight	Gencod	RRP (€)
AWQ820071	8	3,5 g		3,95
AWQ820072	6	5 g		3,95

Trade Pack: x6 (Bulk)



MONTJOIE				
Code	N°H	Weight	Gencod	RRP (€)
162211141	22	0,2 g		3,95
162011141	20	0,2 g		3,95
161811141	18	0,3 g		3,95
161611141	16	0,5 g		3,95
161411141	14	0,6 g		3,95

Trade Pack: x6 (Bulk)

# RIGS PLEASURE

LB : 7 m - ET : 20 cm



PAU				
Code	N°H	Weight	Gencod	RRP (€)
082011141	20	0,3 g		3,95
081811141	18	0,4 g		3,95
081611141	16	0,7 g		3,95

Trade Pack: x6 (Bulk)



PEP Balsa				
Code	N°H	Weight	Gencod	RRP (€)
261811281	18	0,55 g		3,95
261611281	16	0,7 g		3,95
261411281	14	0,8 g		3,95

Trade Pack: x6 (Bulk)



ROYAL				
Code	N°H	Weight	Gencod	RRP (€)
231811141	18	0,2 g		3,95
231611141	16	0,5 g		3,95
231411141	14	0,8 g		3,95
231211141	12	1,25 g		3,95

Trade Pack: x6 (Bulk)



VERSAILLES				
Code	N°H	Weight	Gencod	RRP (€)
192211141	22	0,2 g		3,95
192011141	20	0,3 g		3,95
191811141	18	0,5 g		3,95
191611141	16	0,6 g		3,95
191411141	14	0,5 g		3,95

Trade Pack: x6 (Bulk)

# RIGS TROUT



API				
Code	N°H	Weight	Gencod	RRP (€)
401211141	12	0,8 g		3,95
AWQ820033	10	2,2 g		3,95
AWQ820031	8	3 g		3,95
AWQ820012	6	3 g		3,95

Trade Pack: x6 (Bulk)



CAGNE				
Code	N°H	Weight	Gencod	RRP (€)
841211141	12	2 g		3,95
841011141	10	4 g		3,95
840811141	8	6 g		3,95

Trade Pack: x6 (Bulk)

# RIGS TROUT

LB : 7 m - ET : 20 cm



CEROU				
Code	N°H	Weight	Gencod	RRP (€)
AWQ820074	10	2 g		3,95
AWQ820075	8	3 g		3,95
AWQ820076	6	4 g		3,95

Trade Pack: x6 (Bulk)



ECHEZ				
Code	N°H	Weight	Gencod	RRP (€)
RG8200014	10	3 g		3,95
RG8200015	8	4 g		3,95
RG8200016	6	5 g		3,95

Trade Pack: x6 (Bulk)



KIWI				
Code	N°H	Weight	Gencod	RRP (€)
097112141	12	2,5 g		3,95
097010141	10	4 g		3,95
RG8200001	8	6 g		3,95

Trade Pack: x6 (Bulk)



METEOR PAC				
Code	N°H	Weight	Gencod	RRP (€)
481011141	10	1,3 g		3,95
AWQ820038	8	3 g		3,95

Trade Pack: x6 (Bulk)



OISE				
Code	N°H	Weight	Gencod	RRP (€)
AWQ820058	10	2 g		3,95
AWQ820059	8	3 g		3,95
AWQ820060	6	4 g		3,95

Trade Pack: x6 (Bulk)



SCARPE				
Code	N°H	Weight	Gencod	RRP (€)
AWQ820061	10	2 g		3,95
AWQ820062	8	3 g		3,95
AWQ820063	6	4 g		3,95

Trade Pack: x6 (Bulk)

# RIGS TROUT

LB : 7 m - ET : 20 cm



TROUT				
Code	N°H	Weight	Gencod	RRP (€)
171221421	12	3 g		3,95
171021421	10	3 g		3,95
170821421	8	5 g		3,95

Trade Pack: x6 (Bulk)



TRUST				
Code	N°H	Weight	Gencod	RRP (€)
161231421	12	2,5 g		3,95
161031421	10	3 g		3,95
160831421	8	4 g		3,95

Trade Pack: x6 (Bulk)



TOULOUSAIN ACE				
Code	N°H	Weight	Gencod	RRP (€)
491811141	18	0,6 g		3,95
491611141	16	0,8 g		3,95
491411141	14	1 g		3,95
491211141	12	2 g		3,95
RG8200017	10	2 g		3,95
491011141	10	3 g		3,95
490811141	8	3 g		3,95
AWQ820019	8	2 g		3,95
490621141	6	3 g		3,95
RG8200018	6	4 g		3,95
AWQ820021	4	5 g		3,95

Trade Pack: x6 (Bulk)



TOULOUSAIN ECO SPLIT				
Code	N°H	Weight	Gencod	RRP (€)
RG8200019	10	2 g		3,95
RG8200020	8	3 g		3,95
RG8200021	6	4 g		3,95

Trade Pack: x6 (Bulk)



# RIGS PREDATORS/SEA



Steel 7 kg 40 cm. Treble 9617BZ N°04.

PIKE					
Code	N°H	Size	Weight	Gencod	RRP (€)
201700141	6	LB : 6 cm ET : 27 cm	15 g		9,90

Trade Pack: x6 (Bulk)



Bottom of the steel line

DER					
Code	N°H	Size	Weight	Gencod	RRP (€)
202400141	4	LB : 6 cm ET : 27 cm	15 g		9,90

Trade Pack: x6 (Bulk)



TRANSAT					
Code	N°H	Size	Weight	Gencod	RRP (€)
LMTRA1403	14	LB : 6 m ET : 30 cm	2,5 g		3,90
LMTRA1203	12	LB : 6 m ET : 30 cm	2,5 g		3,90
LMTRA1003	10	LB : 6 m ET : 30 cm	2,5 g		3,90

Trade Pack: x6 (Bulk)



MACKERAL/ GARFISH					
Code	N°H	Size	Weight	Gencod	RRP (€)
LMO200000	6	LB : 6 m ET : 30 cm	10 g		9,45
LMO300000	4	LB : 6 m ET : 30 cm	15 g		9,45
LMO400000	4	LB : 6 m ET : 30 cm	20 g		9,45
LMO500000	2	LB : 6 m ET : 30 cm	30 g		9,95
LMO600000	2	LB : 6 m ET : 30 cm	40 g		11,10

Trade Pack: x6 (Bulk)

# RIGS PREDATORS/SEA



Composition:  
 2x 15 g Isch steel 7 kg 40 cm Treble 9617BZ N°04  
 2x 15 g Pike steel 7 kg 40 cm Treble 9617BZ N°04  
 2x 15 g Steel Whistle 7 kg 40 cm Treble 9617BZ N°04

## PACK 6 ASSORTED RIG LINES



Code	N°H	Size	Gencod	RRP (€)
AWQ830005	4	40 cm		59,90

Trade Pack: x1 (Bulk)

# RIGS KITS



## FISHERIES

Code	N°H	Gencod	RRP (€)
082220141	20		15,45
082118141	18		15,45
371011281	16/18/20		15,45

Trade Pack: x10 (3 per Bag)



## BIG FISH

Code	N°H	Gencod	RRP (€)
187120141	08/10/12		14,00

Trade Pack: x10 (3 per Bag)



## FISHERIES + HOOKS

Code	N°H	Gencod	RRP (€)
292120141	12/14/16		13,00

Trade Pack: x10 (3 per Bag)

# RIGS KITS



HOBBIES			
Code	N°H	Gencod	RRP (€)
082318141	18		14,00
082416141	16		14,00
370011281	14/16/18		14,00

Trade Pack: x10 (3 per Bag)



INITIATION TROUT			
Code	N°H	Gencod	RRP (€)
205700141	6/8/10		13,00

Trade Pack: x10 (3 per Bag)



PACK 3 RIG LINES - TROUT - BIG FISH			
Code	N°H	Gencod	RRP (€)
AWQ830003	12		14,00
AWQ830002	10		14,00
AWQ830001	8		14,00
AWQ830000	6		14,00

Trade Pack: x10 (3 per Bag)

Comes with a hooked hook log



FISHERIES			
Code	N°H	Gencod	RRP (€)
719181141	18		19,85

Trade Pack: x10 (3 per Bag)



PLEASURE + HOOKS			
Code	N°H	Gencod	RRP (€)
718181141	18		18,45
717161141	16		18,45

Trade Pack: x10 (3 per Bag)



TROUT + HOOKS			
Code	N°H	Gencod	RRP (€)
723101141	10		18,45
722081141	8		18,45

Trade Pack: x10 (3 per Bag)



# HOOK TO NYLON FLUOROCARBON FRESHWATER

- Hooks mounted on fluorocarbon line for optimum bait presentation.
- Fluorocarbon line is nearly invisible in water.



SPECIAL ZANDER 0,50 m (7050 BK)

Code	N°H	Ø	Gencod	RRP (€)
950622021	6	22	[Barcode]	7,50
AWQ341222	6	25	[Barcode]	7,50
950422021	4	22	[Barcode]	7,50
950425021	4	25	[Barcode]	7,50
AWQ341221	4	27,5	[Barcode]	7,50
950225021	2	25	[Barcode]	7,50
AWQ341220	2	27,5	[Barcode]	7,50

Trade Pack: x10 (10 per packet)



SPECIAL TROUT - NATURAL BAIT 0,50 m (7040 NI)

Code	N°H	Ø	Gencod	RRP (€)
131212021	12	12,5	[Barcode]	6,70
131215021	12	15	[Barcode]	6,70
131012021	10	12,5	[Barcode]	6,70
131015021	10	15	[Barcode]	6,70
130815021	8	15	[Barcode]	6,70
130817021	8	17,5	[Barcode]	6,70
130617021	6	17,5	[Barcode]	6,70

Trade Pack: x10 (10 per packet)



SPECIAL TROUT - SPADE END BLUE 0,50 m (9333 BL)

Code	N°H	Ø	Gencod	RRP (€)
151215021	12	15	[Barcode]	5,10
151015021	10	15	[Barcode]	5,10
151017021	10	17,5	[Barcode]	5,10
150815021	8	15	[Barcode]	5,10
150817021	8	17,5	[Barcode]	5,10
150820021	8	20	[Barcode]	5,10
150617021	6	17,5	[Barcode]	5,10
150620021	6	20	[Barcode]	5,10
150622021	6	22,5	[Barcode]	5,10
150422021	4	22,5	[Barcode]	5,10

Trade Pack: x10 (10 per packet)



SPECIAL TROUT - SPADE END 0,50 m (7050 BK)

Code	N°H	Ø	Gencod	RRP (€)
141015021	10	15	[Barcode]	6,70
141017021	10	17,5	[Barcode]	6,70
140817021	8	17,5	[Barcode]	6,70
140820021	8	20	[Barcode]	6,70
140620021	6	20	[Barcode]	6,70

Trade Pack: x10 (10 per packet)



SPECIAL WORM - DOUBLE BARB 0,50 m (7053 BN)

Code	N°H	Ø	Gencod	RRP (€)
AWQ340089	10	15	[Barcode]	6,70
AWQ340090	10	12,5	[Barcode]	6,70
AWQ340086	8	17,5	[Barcode]	6,70
AWQ340087	8	15	[Barcode]	6,70
AWQ340084	6	20	[Barcode]	6,70
AWQ340085	6	17,5	[Barcode]	6,70

Trade Pack: x10 (10 per packet)

# HOOK TO NYLON VANADIUM FRESHWATER



**SPECIAL EEL 0,50 m (9290 BZ)**

Code	N°H	Ø	Gencod	RRP (€)
970811021	8	25		5,70
970611021	6	30		5,70
970621021	6	26		5,70
970411021	4	35		5,70
970211021	2	40		5,70

Trade Pack: x10 (10 per packet)



**SURFACE FLOAT HOOK 2 m (7052 BN)**

Code	N°H	Ø	Gencod	RRP (€)
991011021	10	14		5,70
991016021	10	16		5,70
990811021	8	16		5,70
990818021	8	18		5,70
990820021	8	20		5,70
990618021	6	18		5,70
AWQ341202	6	20		5,70
990420021	4	20		5,70

Trade Pack: x10 (10 per packet)



**SPECIAL BOILIES CARP 0,50 m (7102 BK)**

Code	N°H	Ø	Gencod	RRP (€)
960411021	4			5,70
960211021	2			5,70

Trade Pack: x10 (2 per packet)



**SPECIAL CARP 0,50 m (7110 BN)**

Code	N°H	Ø	Gencod	RRP (€)
AWQ340020	8	25		5,70
960621022	6	25		5,70
960421022	4	30		5,70

Trade Pack: x10 (10 per packet)



**SPECIAL FEEDER 1 m (7005 BN)**

Code	N°H	Ø	Gencod	RRP (€)
AWQ340054	18	10		5,90
911612021	16	12		5,90
911412021	14	12		5,90
911414021	14	14		5,90
911214021	12	14		5,90
911216121	12	16		5,90
911016021	10	16		5,90
910818021	8	18		5,90

Trade Pack: x10 (10 per packet)



**SPECIAL ROACH 50 cm (7032 BK)**

Code	N°H	Ø	Gencod	RRP (€)
942021021	20	8		5,70
942011021	20	10		5,70
941821021	18	8		5,70
941811021	18	10		5,70
RG3400006	16	12		5,70
941611021	16	10		5,70
941411021	14	12		5,70

Trade Pack: x10 (10 per packet)



# HOOK TO NYLON VANADIUM FRESHWATER



## SPECIAL TROUT 0,50 m (7050 BK)

Code	N°H	Ø	Gencod	RRP (€)
951011021	10	18		5,70
951021021	10	16		5,70
950811021	8	18		5,70
950611021	6	20		5,70
950421021	4	22		5,70

Trade Pack: x10 (10 per packet)



## SPECIAL TROUT - NATURAL BAIT 0,50 m (7040 NI)

Code	N°H	Ø	Gencod	RRP (€)
381421021	14	12		5,70
381221021	12	12		5,70
381231021	12	14		5,70
381011021	10	12		5,70
381021021	10	14		5,70
380811021	8	14		5,70
380821021	8	16		5,70
380611021	6	16		5,70

Trade Pack: x10 (10 per packet)



## SPECIAL WORM FISHING 0,50 m (7051 BK)

Code	N°H	Ø	Gencod	RRP (€)
281235023	12	14		5,70
281245023	12	12		5,70
281035023	10	14		5,70
281055023	10	12		5,70
281065023	10	16		5,70
280865023	8	16		5,70
280875023	8	12		5,70
280885023	8	14		5,70
280655023	6	16		5,70
280665023	6	14		5,70

Trade Pack: x10 (10 per packet)



These leaders are made with very high-end components, the result of cutting-edge technology and research: RAGOT nylon and VMC PERFECTION hooks. The assembly, entirely realized by hand, is the subject of a rigorous control, guarantee of an irreproachable quality for the fisherman of competition.

## PERFECTION 7002BZ 15 cm (7002 BZ)

Code	N°H	Ø	Gencod	RRP (€)
702211021	22	6,5		5,90
702221021	22	7,6		5,90
702011021	20	6,5		5,90
702021021	20	7,6		5,90
ARA340006	20	9,5		5,90
701821021	18	7,6		5,90
701811021	18	9,5		5,90

Trade Pack: x10 (8 per packet)



These leaders are made with very high-end components, the result of cutting-edge technology and research: RAGOT nylon and VMC PERFECTION hooks. The assembly, entirely realized by hand, is the subject of a rigorous control, guarantee of an irreproachable quality for the fisherman of competition.

## PERFECTION 7003BN 15 cm (7003 BN)

Code	N°H	Ø	Gencod	RRP (€)
721821021	18	7,6		5,90
721831021	18	9,5		5,90
721841021	18	10,6		5,90
721621021	16	9,5		5,90
721631021	16	11,8		5,90

Trade Pack: x10 (8 per packet)

# HOOK TO NYLON CLASSIC FRESHWATER



SPECIAL PREDATOR 0,50 m (9294 NI)				
Code	N°H	Ø	Gencod	RRP (€)
760611021	6	20		3,80
760431021	4	22		3,80
760221021	2	24		3,80

Trade Pack: x10 (10 per packet)



CRISTAL BLUE 0,15 m (9011 BL)				
Code	N°H	Ø	Gencod	RRP (€)
232211022	22	8		3,50
232011022	20	10		3,35
232021022	20	8		3,35
231821022	18	8		3,35
231811022	18	10		3,35
231841022	18	12		3,35
AWQ340096	16	12		3,35

Trade Pack: x10 (10 per packet)



CRISTAL BLUE 0,35 m (9011 BL)				
Code	N°H	Ø	Gencod	RRP (€)
222411023	24	8		3,55
222421028	24	6		3,55
222211022	22	8		3,55
222221027	22	6		3,55
222251021	22	10		3,55
222011021	20	10		3,40
222021021	20	8		3,40
222041021	20	6		3,40
222051021	20	12		3,40
221811021	18	10		3,40
221821021	18	8		3,40
221841022	18	12		3,40
221611021	16	12		3,40
221621021	16	10		3,40
221641021	16	8		3,40
221411021	14	14		3,40
221421021	14	12		3,40

Trade Pack: x10 (10 per packet)



CRISTAL BLUE BARBLESS 0,15 m (9012 BL)				
Code	N°H	Ø	Gencod	RRP (€)
202211023	22	8		3,90
202021023	20	8		3,75
202031023	20	10		3,75
201811023	18	8		3,75
201821023	18	10		3,75
RG3400007	16	10		3,75

Trade Pack: x10 (10 per packet)



CRISTAL BLUE BARBLESS 0,35 m (9012 BL)				
Code	N°H	Ø	Gencod	RRP (€)
202421021	24	8		3,90
202431021	24	6		3,90
202211021	22	8		3,90
202211022	22	6		3,90
202021021	20	8		3,80
202031021	20	10		3,80
201821021	18	8		3,80
201821022	18	10		3,80
201822022	18	12		3,80
201611021	16	10		3,80
201641021	16	12		3,80

Trade Pack: x10 (10 per packet)



CRISTAL RED 0,35 m (9013 RD)				
Code	N°H	Ø	Gencod	RRP (€)
352021021	20	8		3,75
351811021	18	10		3,75

Trade Pack: x10 (10 per packet)



# HOOK TO NYLON CLASSIC FRESHWATER



## FORGED BRONZE STRAIGHT SPADE 0,50 m (9408 BZ)

Code	N°H	Ø	Gencod	RRP (€)
212211022	22	8	[Barcode]	3,55
212021021	20	8	[Barcode]	3,45
212011021	20	10	[Barcode]	3,45
211821021	18	8	[Barcode]	3,45
211811021	18	10	[Barcode]	3,45
211731021	18	12	[Barcode]	3,45
211621021	16	10	[Barcode]	3,45
211611021	16	12	[Barcode]	3,45
211671021	16	14	[Barcode]	3,45
211421021	14	12	[Barcode]	3,45
211411021	14	14	[Barcode]	3,45
211441022	14	16	[Barcode]	3,45
211271022	12	14	[Barcode]	3,45
211221021	12	16	[Barcode]	3,45
211211021	12	18	[Barcode]	3,45
211051022	10	14	[Barcode]	3,45
211071021	10	16	[Barcode]	3,45
211021021	10	18	[Barcode]	3,45
211011021	10	20	[Barcode]	3,45
210871021	8	16	[Barcode]	3,45
210861021	8	18	[Barcode]	3,45
210851021	8	20	[Barcode]	3,45
210841022	8	22	[Barcode]	3,45
210681022	6	18	[Barcode]	3,45
210641022	6	20	[Barcode]	3,45
210661022	6	22	[Barcode]	3,45
210671021	6	24	[Barcode]	3,45
210441022	4	22	[Barcode]	3,45
210451021	4	24	[Barcode]	3,45
210471021	4	26	[Barcode]	3,45
210241021	2	26	[Barcode]	3,45

Trade Pack: x10 (10 per packet)



## CRISTAL GOLD 0,35 m (9016 GO)

Code	N°H	Ø	Gencod	RRP (€)
241811021	18	10	[Barcode]	3,75
241641022	16	10	[Barcode]	3,75
241611021	16	12	[Barcode]	3,75
241441021	14	12	[Barcode]	3,75
241411021	14	14	[Barcode]	3,75
241241022	12	16	[Barcode]	3,75
241021021	10	18	[Barcode]	3,75

Trade Pack: x10 (10 per packet)

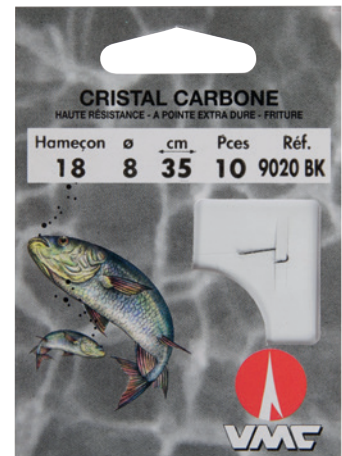

## CRISTAL CARBON 0,35 m (9020 BK)

Code	N°H	Ø	Gencod	RRP (€)
252011021	20	8	[Barcode]	3,75
252021021	20	10	[Barcode]	3,75
251831021	18	8	[Barcode]	3,75
251821021	18	10	[Barcode]	3,75
251611021	16	12	[Barcode]	3,75

Trade Pack: x10 (10 per packet)



## CRYSTAL BRONZE LONG SPADE 0,35 m (9009 BZ)

Code	N°H	Ø	Gencod	RRP (€)
482281021	22	8	[Barcode]	3,85
482081021	20	8	[Barcode]	3,75
481811022	18	8	[Barcode]	3,75
481882021	18	10	[Barcode]	3,75
481621022	16	10	[Barcode]	3,75
481611022	16	12	[Barcode]	3,75

Trade Pack: x10 (10 per packet)



## FORGED BRONZE OUT TURNED SPADE 0,50 m (9284 BZ)

Code	N°H	Ø	Gencod	RRP (€)
261425021	14	12	[Barcode]	3,45
261225021	12	16	[Barcode]	3,45
261215021	12	18	[Barcode]	3,45
261025021	10	18	[Barcode]	3,45
261055021	10	20	[Barcode]	3,45
260845021	8	18	[Barcode]	3,45
260825021	8	20	[Barcode]	3,45
260835021	8	22	[Barcode]	3,45
260811021	8	24	[Barcode]	3,45
260615021	6	20	[Barcode]	3,45
260625021	6	22	[Barcode]	3,45
260635021	6	24	[Barcode]	3,45
260425021	4	24	[Barcode]	3,45

Trade Pack: x10 (10 per packet)

# HOOK TO NYLON CLASSIC FRESHWATER



## CRISTAL NICKEL 0,35 m (9016 NI)

Code	N°H	Ø	Gencod	RRP (€)
RG3400008	20	0,1		3,75
231811021	18	0,1		3,75
231611021	16	0,12		3,75
231411021	14	0,14		3,75

Trade Pack: x10 (10 per packet)



## FORGED BLUE OUT TURNED SPADE 0,50 m (9335 BL)

Code	N°H	Ø	Gencod	RRP (€)
271425021	14	12		3,75
271215021	12	16		3,75
271225021	12	14		3,75
271255021	12	12		3,75
271075021	10	12		3,75
271035021	10	16		3,75
271065021	10	14		3,75
271015021	10	18		3,75
271031021	10	20		3,75
270811021	8	16		3,75
270815021	8	18		3,75
270821021	8	14		3,75
270825021	8	20		3,75
270827021	8	22		3,75
270711021	7	18		3,75
270725021	7	20		3,75
270615021	6	18		3,75
270625021	6	22		3,75
270631021	6	20		3,75
270645021	6	16		3,75
270535021	5	20		3,75
270415021	4	22		3,75
270425021	4	24		3,75
270435021	4	20		3,75
270445021	4	18		3,75
270316021	3	24		3,75
270215021	2	24		3,75

Trade Pack: x10 (10 per packet)



## FORGED BLUE OUT TURNED SPADE BARBLESS 0,50 m (9336 BL)

Code	N°H	Ø	Gencod	RRP (€)
AWQ340094	10	18		4,15
AWQ340025	10	16		4,15
AWQ340024	10	14		4,15
AWQ340023	8	18		4,15
AWQ340022	8	16		4,15
AWQ340093	6	20		4,15
AWQ340021	6	18		4,15
AWQ340092	4	22		4,15
AWQ340091	4	20		4,15

Trade Pack: x10 (10 per packet)



## FORGED BLUE OUT TURNED SPADE RESINED 0,50 m (9333 BL)

Code	N°H	Ø	Gencod	RRP (€)
281225021	12	16		4,15
281075021	10	16		4,15
281085021	10	20		4,15
281095021	10	18		4,15
280875021	8	16		4,15
280885021	8	20		4,15
280895021	8	18		4,15
280635021	6	20		4,15
280685021	6	22		4,15
280695021	6	18		4,15
280465021	4	20		4,15
280485021	4	24		4,15
280495021	4	22		4,15

Trade Pack: x10 (10 per packet)



## SPECIAL TROUT PASTE 0,70 m (9335 BL)

Code	N°H	Ø	Gencod	RRP (€)
911216021	12	16		6,25
911018021	10	18		6,25
910820021	8	20		6,25
910622021	6	22		6,25
910424021	4	24		6,25

Trade Pack: x10 (10 per packet)

# HOOK TO NYLON FLUOROCARBONE SEA

- Hooks mounted on fluorocarbon line for optimum bait presentation.
- Fluorocarbon line is nearly invisible in water.



## SPECIAL BIBI 1,50 m (8294 S)

Code	N°H	Ø	Gencod	RRP (€)
500625021	6	25		9,95
500425021	4	25		9,95
500430021	4	30		9,95
500230021	2	30		9,95

Trade Pack: x10 (10 per packet)



## SPECIAL BREAM CURVE 1,50 m (7210 BN)

Code	N°H	Ø	Gencod	RRP (€)
160625021	6	25		7,65
160627021	6	27,5		7,65
160425021	4	25		7,65
160427021	4	27,5		7,65
160430021	4	30		7,65
160227021	2	27,5		7,65
160230021	2	30		7,65
160235021	2	35		7,65
160130021	1	30		7,65
160135021	1	35		7,65
160030021	1/0	35		8,50
160240021	2/0	40		9,30

Trade Pack: x10 (10 per packet)



## SPECIAL SPARIDAE 2 m (7235 BN)

Code	N°H	Ø	Gencod	RRP (€)
AWQ340040	8	20		8,05
AWQ340041	8	22,5		8,05
AWQ340038	6	20		8,05
AWQ340039	6	22,5		8,05
AWQ340036	4	22,5		8,05
AWQ340037	4	25		8,05
AWQ340035	2	25		8,05

Trade Pack: x10 (6 per packet)

Double boom hooks for

fishing with crabs

- Fluorocarbon

- Hook VMC 7210

- Loop at the end

- Mounting 2 hooks Wishbone



## CRAB RIG 150 cm (7210)

Code	N°H	Ø	Gencod	RRP (€)
RG1220003	4	0,275		7,75
RG1220004	2	0,30		7,75
RG1221002	1	0,30		7,75

Trade Pack: x10 (4 per packet)



# HOOK TO NYLON CLASSIC SEA



## SPECIAL BREAM CURVE 1,50 m (7110 BN)

Code	N°H	Ø	Gencod	RRP (€)
870611021	6	26		4,80
120612021	6	28		4,80
870411021	4	28		4,80
870412021	4	26		4,80
120411021	4	30		4,80
120211021	2	28		4,80
870211021	2	30		4,80
120212021	2	35		4,80
870111021	1	30		4,80
120112021	1	35		4,80
870011021	1/0	35		5,20

Trade Pack: x10 (10 per packet)



## REVERSED TIN 1,50 m (9284 PS)

Code	N°H	Ø	Gencod	RRP (€)
101031021	10	26		3,85
100841021	8	28		3,85
100631021	6	30		3,85
100431021	4	30		3,85
100231021	2	35		3,85
100121021	1	35		3,85
100011021	1/0	35		3,85
102011021	2/0	40		3,85

Trade Pack: x10 (10 per packet)



## FORGED BRONZE MEDITERRANEAN SPECIAL 1,20 m (9284 BZ)

Code	N°H	Ø	Gencod	RRP (€)
261004021	10	24		3,85
260814022	8	26		3,85
260624022	6	28		3,85
260424022	4	28		3,85
260234021	2	30		3,85

Trade Pack: x10 (10 per packet)



## SPECIAL WORM CURVED ENGLISH 1,50 m (9333 BL)

Code	N°H	Ø	Gencod	RRP (€)
280641021	6	24		4,35
280421021	4	24		4,35
280431021	4	26		4,35

Trade Pack: x10 (10 per packet)



## ROCK FISH 0,50 m (9408 NI)

Code	N°H	Ø	Gencod	RRP (€)
AWQ340033	14	18		3,65
AWQ340031	12	20		3,65
AWQ340032	12	22		3,65
AWQ340030	10	24		3,65
AWQ340027	8	22		3,65
AWQ340028	8	24		3,65

Trade Pack: x10 (10 per packet)

# HOOK TO NYLON CLASSIC SEA

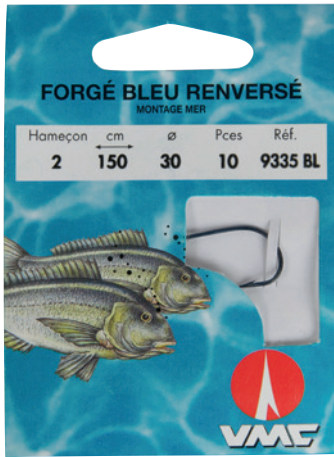

**FORGED BLUE REVERSED 1,50 m (9335 BL)**

Code	N°H	Ø	Gencod	RRP (€)
271412021	14	22		3,85
271232021	12	22		3,85
271022021	10	24		3,85
270822021	8	24		3,85
270826022	8	26		3,85
270612021	6	24		3,85
270622021	6	26		3,85
270535022	5	28		3,85
270412021	4	26		3,85
270413021	4	24		3,85
270422021	4	28		3,85
270432021	4	30		3,85
270312021	3	30		3,85
270212021	2	28		3,85
270222021	2	30		3,85
270232021	2	35		3,85
270112022	1	35		3,85

Trade Pack: x10 (10 per packet)



**FORGED BRONZE SHORT ROD 1,20 m (9408 BZ)**

Code	N°H	Ø	Gencod	RRP (€)
211641023	16	20		3,65
211441023	14	22		3,65
211241023	12	26		3,65
211281021	12	24		3,65
211041023	10	26		3,65
210841023	8	28		3,65
210621023	6	28		3,65
210651022	6	30		3,65
210451022	4	30		3,65
213231021	2	35		3,65
210151021	1	35		3,65

Trade Pack: x10 (10 per packet)



**SPECIAL SURF CURVE 1,50 m (9145 BL)**

Code	N°H	Ø	Gencod	RRP (€)
730611021	6	28		3,85
730411021	4	30		3,85
730211021	2	35		3,85

Trade Pack: x10 (10 per packet)



# DISGORGER

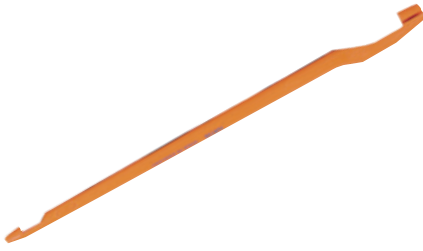

## TWIN END DISGORGER

Code	Size	Gencod	RRP (€)
112110251	17,5		0,95

Trade Pack: x10 (Bulk)

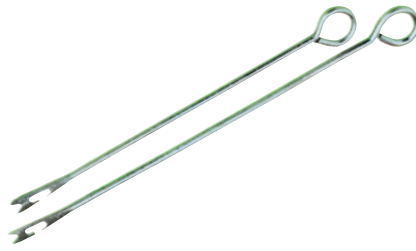

## METAL DISGORGER

Code	Size	Gencod	RRP (€)
670140221	14		1,65
670160221	16		1,65

Trade Pack: x10 (2 per Bag)

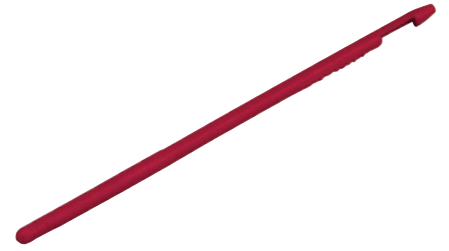

## SINGLE END DISGORGER

Code	Size	Gencod	RRP (€)
670000221	14		1,85

Trade Pack: x10 (2 per Bag)

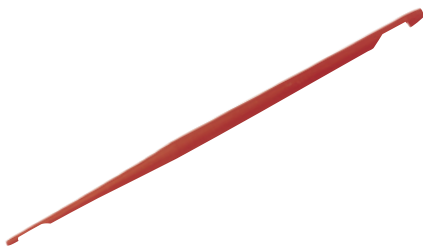

## TWIN END DISGORGER - MICRO

Code	Size	Gencod	RRP (€)
321000221	16		2,10

Trade Pack: x10 (2 per Bag)

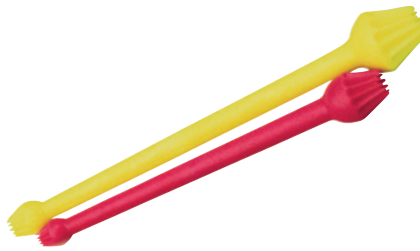

## TULIP DISGORGER - 14CM

Code	Size	Gencod	RRP (€)
671140221	14		2,20
671000221	17		2,20

Trade Pack: x10 (2 per Bag)

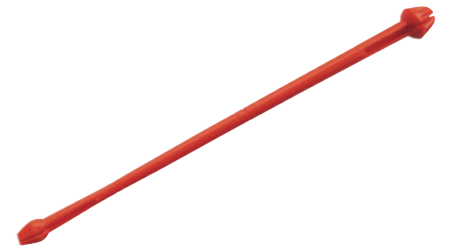

## TULIP DISGORGER - MICRO

Code	Size	Gencod	RRP (€)
671100221	16		2,20

Trade Pack: x10 (2 per Bag)



## BRASS TWIN END DISGORGER

Code	Size	Gencod	RRP (€)
AWQ010034	0,13		2,55

Trade Pack: x10 (1 per Bag)



## DISGORGER + NEEDLE

Code	Size	Gencod	RRP (€)
671002221	Small		2,20
671001221	Large		2,20

Trade Pack: x10 (2 per Bag)

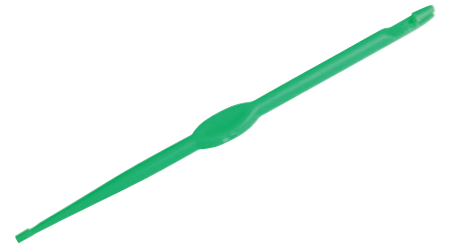

## TWIN END DISGORGER

Code	Gencod	RRP (€)
AWQ010130		1,40

Trade Pack: x10 (1 per Bag)



## GUIDED WIRE DISGORGER

Code	Gencod	RRP (€)
AWQ010131		1,75

Trade Pack: x10 (1 per Bag)



## TROUT DISGORGER KIT

Code	Gencod	RRP (€)
AWQ010035		2,55

Trade Pack: x10 (3 per Bag)



## DISGORGER KIT

Code	Gencod	RRP (€)
AWQ010036		2,55

Trade Pack: x10 (3 per Bag)



# ACCESSORIES



## LONG PLIERS

Code	Size	Gencod	RRP (€)
AWQ010009	20 cm		11,45

Trade Pack: x10 (1 per Bag)



## LONG PLIERS - CURVED

Code	Size	Gencod	RRP (€)
AWQ010010	25 cm		13,85

Trade Pack: x10 (1 per Bag)



## PLIERS & SCISSORS

Code	Size	Gencod	RRP (€)
315200221	15 cm		9,45

Trade Pack: x10 (1 per Bag)



## FISHING PLIERS

Code	Size	Gencod	RRP (€)
315400221	11 cm		8,00

Trade Pack: x10 (1 per Bag)

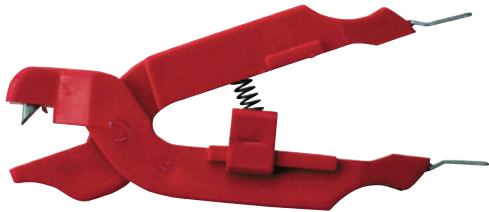

## DOUBLE FUNCTION PINCERS

Code	Gencod	RRP (€)
993001221		7,30

Trade Pack: x3 (1 per Bag)



## HOOK SHARPENER

Code	Gencod	RRP (€)
AWQ010050		2,55

Trade Pack: x5 (1 per Blister)

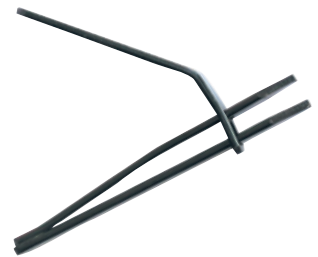

## STYLE PINCERS

Code	Gencod	RRP (€)
955001211		11,00

Trade Pack: x3 (1 per Bag)



## PIKE GAG - FLAT

Code	Size	Gencod	RRP (€)
641220221	18 cm		3,60

Trade Pack: x10 (1 per Bag)



## PIKE GAG

Code	Size	Gencod	RRP (€)
641210221	18 cm		3,60

Trade Pack: x10 (1 per Bag)



Composition: 1 ball gag, 1 clamp, 1 metal disgorger and an 18 cm baiting needle.

## PREDATOR ACCESSORY KIT

Code	Gencod	RRP (€)
AWQ010067		16,99

Trade Pack: x3

# ACCESSORIES



## RIG ANCHORS

Code	Gencod	RRP (€)
641310221		1,85

Trade Pack: x10 (10 per Bag)



## RUBBER WASHERS

Code	Gencod	RRP (€)
630200221		1,85

Trade Pack: x10 (20 per Bag)



## STANDARD CATAPULT

Code	Gencod	RRP (€)
118000221		7,65

Trade Pack: x1 (Bag)



## ELASTIC POLE CONNECTOR

Code	Ø	Gencod	RRP (€)
AWQ010041	1,5		1,30
AWQ010042	1,8		1,30
AWQ010043	2		1,30
AWQ010044	2,3		1,30
AWQ010045	2,5		1,30

Trade Pack: x10 (2 per Bag)



Composition :

- Small : 5 mm, 4 mm, 3 mm, 3 mm, 3 mm, 2 mm
- Medium : 3 mm, 2 mm, 2 mm, 1,5 mm, 1,5 mm, 1,0 mm

## FLOAT RUBBER ASSORTMENT

Code	Size	Gencod	RRP (€)
641112221	Small		3,70
641112221	Medium		3,70

Trade Pack: x10 (1 per Bag)

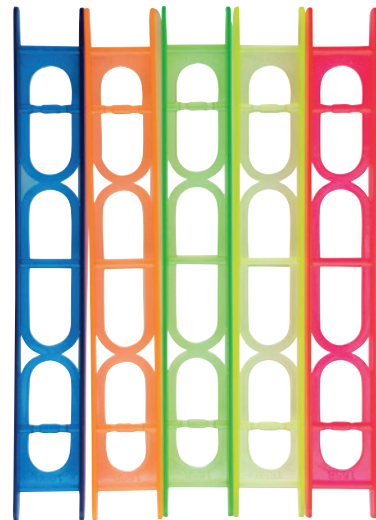

## RIG WINDERS x 5

Code	Size	Gencod	RRP (€)
AWQ010030	16		2,90
AWQ010031	18		2,90

Trade Pack: x10 (5 per kit)



## RUBBER BANDS

Code	Gencod	RRP (€)
AWQ010104		4,05

Trade Pack: x10 (50 per packet)



# ACCESSORIES

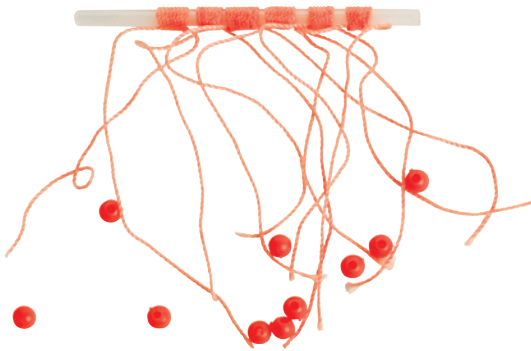

## SLIDING STOP BEADS

Code	Size	Ø	Color	Gencod	RRP (€)
695100221	Small	2,5	Red		0,95
695000221	Large	3	Red		0,95

Trade Pack: x10 (12 per Bag)



## FLOAT CONNECTOR - CLIP

Code	Gencod	RRP (€)
106001221		2,20

Trade Pack: x10 (4 per Bag)



- Metal feeder
- 5 squares
- Wire loop
- Mat black color

## METAL CAGE FEEDER

Code	Weight	Gencod	RRP (€)
RG0100013	20 g		3,25
RG0100014	30 g		3,50
RG0100015	40 g		3,75

Trade Pack: x10 (1 per Bag)



Designed to help thread pole elastic through hollow sections.

## DIAMOND EYE THREADER

Code	Size	Gencod	RRP (€)
957001211	2 m		5,10

Trade Pack: x3 (1 per Bag)



## RIG ANCHORS

Code	Size	Gencod	RRP (€)
994001221	10 cm		3,25
ARA010026	15 cm		4,40

Trade Pack: x6 (10 per Bag)



## PELLET BANDS

Code	Ø	Gencod	RRP (€)
ARA010048	7 mm		3,00
ARA010049	10 mm		3,00

Trade Pack: x6 (18 per Bag)



## FISH COUNTER

Code	Gencod	RRP (€)
ARA010029		5,70

Trade Pack: x6



## ANTI TANGLE BOOM

Code	Size	Gencod	RRP (€)
245050221	5		1,85
129200221	15		1,85
129300221	25		2,20

Trade Pack: x10 (3 per Bag)

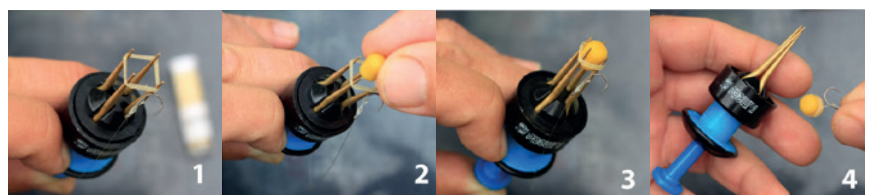
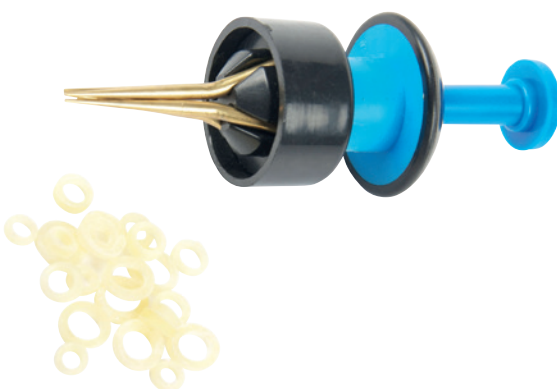

## PELLET BANDER + 30 BANDS

Code	Gencod	RRP (€)
ARA010148		8,30

Trade Pack: x5

# NEEDLES



Essential Baiting Needle, can be used with fragile or tougher baits, designed with one end cut at a 45° angle and hollow. 50 Units supplied in a presentation tube.

WORM NEEDLE x 50					
Code	Size	Ø	Material	Gencod	RRP (€)
RG0300291	20 cm	1 mm	Stainless steel		32,25

Trade Pack: x10

Glow handle for easy identification at night. Two diameters for fragile or big baits.



SURF RIG NEEDLES 25CM					
Code	Size	Ø	Material	Gencod	RRP (€)
RG0300256	25 cm	1,80 mm	Stainless steel		3,80
RG0300253	25 cm	1,20 mm	Stainless steel		3,80

Trade Pack: x10

These baiting needles have a specially designed loop to thread live or dead fish. The smallest is perfect for mounting a minnow while the larger (20 cm) is more suitable for a sandeel.

EYED NEEDLE					
Code	Size	Ø	Material	Gencod	RRP (€)
246120221	12 cm	0,80 mm	Stainless steel		2,10
101700221	18 cm	0,80 mm	Stainless steel		2,20

Trade Pack: x10 (2 per Bag)

These robust and inflexible brass needles have been specially developed to easily mount weak baits such as trawl worms, pistiches, lugworms and when freshwater fishing large worms such as Canadian, earthworms etc.

BRASS NEEDLE					
Code	Size	Ø	Material	Gencod	RRP (€)
121152221	15 cm	1,50 mm	Brass		2,55
122202221	20 cm	1,50 mm	Brass		2,90

Trade Pack: x10 (2 per Bag)

These needles are undoubtedly among the most versatile in the range because they are suitable for both long bait fragile (nereids and lugworms) as for larger worms (Canadian, earthworms).

HOLLOW STAINLESS STEEL NEEDLE					
Code	Size	Ø	Material	Gencod	RRP (€)
700020221	20 cm	1 mm	Stainless steel		2,80

Trade Pack: x10 (2 per Bag)

The bevelled edge design greatly facilitates easy mounting and help preserve the bait. They are also very practical for stitching tube worms, that are a little harder than classical worms.

STAINLESS STEEL NEEDLE					
Code	Size	Ø	Material	Gencod	RRP (€)
123202221	20 cm	1 mm	Stainless steel		3,25

Trade Pack: x10 (2 per Bag)

A classic design that you can use for many types of baits including large worms.

STAINLESS STEEL NEEDLE					
Code	Size	Ø	Material	Gencod	RRP (€)
121202221	20 cm	1 mm	Stainless steel		3,25

Trade Pack: x10 (2 per Bag)

This model has been specifically developed for easily mounting the bait. Both needles will also work perfectly for all fragile worms. Stainless steel gives a good rigidity to the whole.

STAINLESS STEEL NEEDLE FULL RING					
Code	Size	Ø	Material	Gencod	RRP (€)
129600221	18 cm	1 mm	Stainless steel		3,45

Trade Pack: x10 (2 per Bag)

Designed with a plastic tip which is really handy to avoid piercing the worm from side-to-side when mounting. The ideal model for delicate baits.

NEEDLE WITH TIP					
Code	Size	Ø	Material	Gencod	RRP (€)
AWQ010093	20 cm	0,90 mm	Stainless steel		4,50

Trade Pack: x10 (2 per Bag)

# ACCESSORIES



## RUN CLIP GM

Code	Ø	Gencod	RRP (€)
702000221	1,80 cm		1,85

Trade Pack: x10 (2 per Bag)



## DOUBLE BELL WITH EARS

Code	Size	Gencod	RRP (€)
AGD181B0	18 mm		2,45

Trade Pack: x10 (2 per Bag)



## BELL WITH CROCODILE CLIP

Code	Gencod	RRP (€)
075703221		2,55

Trade Pack: x10



Weighs up to 27 kg and includes a built-in tape measure.

## SCALE

Code	Gencod	RRP (€)
119300221		12,50

Trade Pack: x1



- Lightweight aluminium and plastic fish catcher.
- Supports up to 25 lb of weight.
- Adjustable elastic cord to avoid its loss when in use.

## LIGHTWEIGHT CATCHER 25LB

Code	Gencod	RRP (€)
RG0300303		25,30

Trade Pack: x1



- A practical tape measure for measure your catch.
- Space-saving and very light.

## METRE RULER 1,50 m

Code	Gencod	RRP (€)
AWQ010008		4,30

Trade Pack: x1 (1 per Bag)



Composition: 1 blue detector, 1 U-shaped head, 2 aluminum spikes 60/90, a 12 V battery.

## BITE DETECTION KIT

Code	Gencod	RRP (€)
AWQ490001		41,90

Trade Pack: x1



## BITE DETECTION KIT

Code	Gencod	RRP (€)
AWQ490002		14,55

Trade Pack: x1

- To be fixed directly on the rod between the reel and the first ring.
- Once the casting is done, place the nylon in the pulley and check the switched on by the blue activation of the LED and sound.
- Blue LED, time delay about 20 seconds.
- ON / OFF positions under the detector.
- Supplied with 3 V13GA batteries.



Very easy to operate and quick to lock on weight readings, can record in kilograms, pounds or ounces. Can be zeroed after adding a weigh net or bag, while a blue back light keeps the screen visible in dark conditions. A 1m tape measure extends from the left side of the body with a TPR none grip handle, Requires one CR2032 lithium battery (not included).

## COMPACT DIGITAL SCALE 25KG

Code	Gencod	RRP (€)
RG0100005		42,90

Trade Pack: x1

# ACCESSORIES



## ASSORTMENT FLOAT STOP SILICON

Code	Size	Specifications	Gencod	RRP (€)
102700221	Medium	Ø recommended for nylon : 20 to 25/100 e		1,05
102800221	Large	Ø recommended for nylon : 20 to 35/100 e		1,05
102900221	Very Large	Ø recommended for nylon : +35/100 e		1,05

Trade Pack: x10 (15 per Bag)



## SOFT RUBBER BEADS

Code	Ø	Gencod	RRP (€)
AWQ010088	4		2,10
AWQ010089	6		2,10
AWQ010090	8		2,10

Trade Pack: x10 (20 per Bag)



Rolling swivel fixed between 2 phospho beads and 2 rubber stopper to be threaded on the line and placed at the desired location. 3 sizes.

## ROLLING STOPPER WITH CONICAL RUBBER

Code	Size	Gencod	RRP (€)
RG0100008	S		2,10
RG0100007	M		2,10
RG0100006	L		2,10

Trade Pack: x10

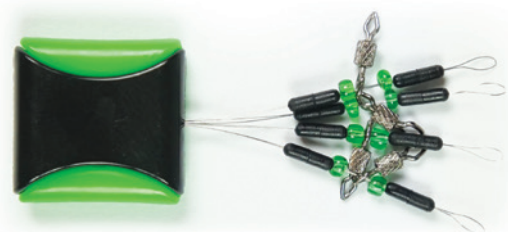

Rolling swivel fixed between 2 beads and 2 rubber stopper to be threaded on the line and placed at the desired location. 3 sizes.

## ROLLING STOPPER WITH ELONGATED RUBBER

Code	Size	Gencod	RRP (€)
RG0100011	S		2,10
RG0100010	M		2,10
RG0100009	L		2,10

Trade Pack: x10



## LINE STOPPER LONG BLACK

Code	Size	Specifications	Gencod	RRP (€)
129700221	S	Ø recommended for nylon : 0,15-0,25		2,10
129800221	M	Ø recommended for nylon : 0,25-0,35		2,10
129900221	L	Ø recommended for nylon : 0,30-0,40		2,10
130001221	XL	Ø recommended for nylon : 0,40-0,50		2,10
130100221	XXL	Ø recommended for nylon : 0,45-0,55		2,10

Trade Pack: x10 (6 per Bag)



## LINE STOPPER LUXE BLACK

Code	Size	Specifications	Gencod	RRP (€)
974001221	S	Ø recommended for nylon : 0,15-0,25		2,10
975002221	M	Ø recommended for nylon : 0,25-0,35		2,10
976003221	L	Ø recommended for nylon : 0,30-0,40		2,10
977004221	XL	Ø recommended for nylon : 0,40-0,50		2,30
978005221	XXL	Ø recommended for nylon : 0,45-0,55		2,30
979006221	XXL	Ø recommended for nylon : 0,50-0,60		2,30

Trade Pack: x10 (10 per Bag)



# ACCESSORIES/TIPS

## HOLLOW CARBON TIP

Code	Size	Ø	Gencod	RRP (€)
130500221	1 m	Butt : 3,9 - Tip : 1,6		10,50
130600221	1 m	Butt : 4,2 - Tip : 1,8		10,50
130700221	1 m	Butt : 4,7 - Tip : 2		10,50
130800221	1 m	Butt : 5,2 - Tip : 2		10,50
130900221	1 m	Butt : 5,7 - Tip : 2		10,50
131000222	1 m	Butt : 6,2 - Tip : 2,2		10,50

Trade Pack: x5 (Bulk)



## HOLLOW CARBON TIP + TUBE

Code	Size	Ø	Gencod	RRP (€)
RG0100016	1 m	Butt : 3,9 - Tip : 1,6		11,90
RG0100017	1 m	Butt : 4,2 - Tip : 1,8		11,90
RG0100018	1 m	Butt : 4,7 - Tip : 2		11,90
RG0100019	1 m	Butt : 5,2 - Tip : 2		11,90
RG0100020	1 m	Butt : 5,7 - Tip : 2		11,90
RG0100021	1 m	Butt : 6,2 - Tip : 2,2		11,90

Trade Pack: x1

Mounted on elastic band

## HOLLOW CARBON TIP PRE-ELASTICATED

Code	Size	Ø	Color	Gencod	RRP (€)
AWQ010142	90 cm	Butt : 4,2 - Elastic : 1	Fluo Yellow		21,50
AWQ010143	90 cm	Butt : 4,7 - Elastic : 1,2	Fluo Red		21,50
AWQ010144	90 cm	Butt : 5,2 - Elastic : 1,4	Dark Green		21,50

Trade Pack: x1 (1 per Bag)



### SANDOWSKI

Code	Gencod	RRP (€)
ATO010053		1,70

Trade Pack: x25 (Bulk)



### SANDOWSKI

Code	Gencod	RRP (€)
AA0027200		3,70

Trade Pack: x10 (2 per Bag)



### SANDOW

Code	Gencod	RRP (€)
AA0027100		3,70

Trade Pack: x10 (2 per Bag)

# ACCESSORIES



## STAINLESS STEEL PIANO WIRE 10 m

Code	Ø	Specifications	Gencod	RRP (€)
C901.10.30	30/100	Inox 302		4,60
C901.10.40	40/100	Inox 302		4,60
C901.10.50	50/100	Inox 302		4,60
C901.10.60	60/100	Inox 302		4,60
C901.10.70	70/100	Inox 302		4,60
C901.10.80	80/100	Inox 302		5,90
C901.10.90	90/100	Inox 302		5,90
C901.10.100	100/100	Inox 302		5,90
C901.10.120	120/100	Inox 302		5,90

Trade Pack: x10 (1 per Bag)



## COPPER WIRE 10 m

Code	Ø	Gencod	RRP (€)
C902.10.30	30/100		2,65
C902.10.40	40/100		2,65
C902.10.50	50/100		2,65

Trade Pack: x10 (1 per Bag)

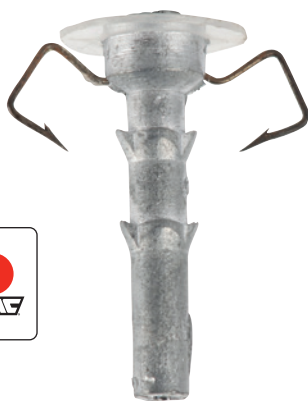

Mounted on VMC hooks

## DOUBLE GODILE

Code	Strength	Gencod	RRP (€)
AVM010003	2 g		6,95
AVM010004	2,5 g		6,95
AVM010005	3 g		6,95
AVM010006	4 g		6,95
AVM010007	5 g		6,95
AVM010008	6 g		6,95

Trade Pack: x6 (5 per Blister)



- 1x7 Stainless Steel coated wire quality 304
- Multi-purpose type of fishing
- Including with 10 sleeves

## STAINLESS COATED WIRE 10M + 10 SLEEVES

Code	Weight	Gencod	RRP (€)
RG0300316	9 kg		4,95
RG0300317	11 kg		5,00
RG0300318	13 kg		5,10
RG0300319	18 kg		5,20
RG0300320	22 kg		5,30
RG0300321	27 kg		5,40
RG0300322	31 kg		5,50
RG0300323	36 kg		5,70
RG0300324	40 kg		5,90

Trade Pack: x6 (1 per Bag)

# ACCESSORIES



Protectors for jig crowns or lure trebles, very practical and lightweight to prevent our lures from snagging on any surface.

PROTECTOR MULTICOLOR			
Code	Size	Gencod	RRP (€)
RG0300297	M		3,35
RG0300296	L		3,35

Trade Pack: x10 (6 per Blister)



# ACCESSORIES TROUT/TOC



- Realistic imitations of ringworms.
- 4 Different colours.
- Flavoured with vanilla.

IMITATION MOTH GRUB			
Code	Color	Gencod	RRP (€)
AWQ010055	Yellow		4,85
AWQ010056	White		4,85
AWQ010058	Orange		4,85
AWQ010059	Red		4,85

Trade Pack: x10 (15 per Bag)



Maggot/ Bait bag. Adjustable strap to pass around the neck. Opening / closing by zip.

MAGGOTS BAG			
Code	Size	Gencod	RRP (€)
RG0100012	L		11,45

Trade Pack: x1



# ACCESSORIES TROUT/TOC

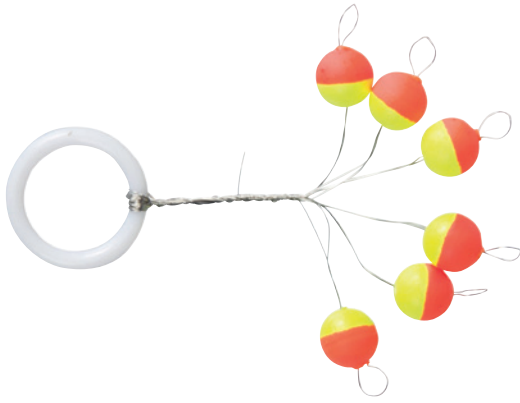

ROUND WIRE GUIDE				
Code	Ø	Color	Gencod	RRP (€)
150001221	4 mm	Yellow Orange		2,60
146300221	6 mm	Yellow Orange		2,60
146700221	6 mm	Orange & Yellow Black		2,60
149700221	8 mm	Yellow Orange		2,60

Trade Pack: x10 (6 per Bag)

OVAL WIRE GUIDE				
Code	Size	Color	Gencod	RRP (€)
149800221	4 X 10 mm	Yellow Orange		2,60
146800221	6 x 12 mm	Yellow Orange		2,60
149900221	8 x 14 mm	Yellow Orange		2,60

Trade Pack: x10 (6 per Bag)

Sight indicators designed to be placed on the line body to follow the movement of the line in the current and show takes from fish.

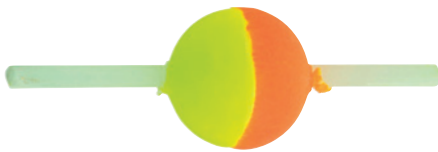

ROUND INDICATORS			
Code	Ø	Gencod	RRP (€)
AWQ010116	4 mm		3,00
AWQ010117	6 mm		3,00
AWQ010118	8 mm		3,00

Trade Pack: x10 (10 per Bag)

OVAL INDICATORS			
Code	Size	Gencod	RRP (€)
AWQ010120	6 x 12 mm		3,00

Trade Pack: x10 (10 per Bag)

CYLINDRICAL INDICATORS			
Code	Ø	Gencod	RRP (€)
AWQ010123	6 mm		3,35

Trade Pack: x10 (10 per Bag)



INCASSABLE			
Code	Ø	Gencod	RRP (€)
ARA330001	10 mm		3,35
ARA330002	12 mm		3,35
ARA330003	14 mm		3,35
ARA330004	18 mm		3,35

Trade Pack: x6 (6 per Bag)



POLYSTYRENE BALLS			
Code	Color	Gencod	RRP (€)
153700221	White		4,50
153800221	Yellow Orange		4,50

Trade Pack: x5 (1 per Bag)



# BOXES



## BAIT BOXES

Code	Ø	Gencod	RRP (€)
047910251	70		1,40
111110251	85		1,65

Trade Pack: x10



## MAGGOT BOX

Code	Ø	Gencod	RRP (€)
036310251	100		1,85
036410251	110		2,10

Trade Pack: x10



## WHEAT BUCKET

Code	Size	Gencod	RRP (€)
044810251	1/2 L		3,25

Trade Pack: x1



## CLIC CLAC BOX

Code	Gencod	RRP (€)
AWQ140015		4,55

Trade Pack: x10



Small foldable box to keep your small accessories, swivels or hooks.

## SMALL ACCESSORY BOX

Code	Gencod	RRP (€)
RG1421004		3,35

Trade Pack: x1



Double-sided box that allows you to store 6+6 hard lures. Water drain hole for quick drying and avoid corrosion of hooks.

## DOUBLE SIDE BOX 6+6 CASES

Code	Gencod	RRP (€)
RG1421005		4,55

Trade Pack: x1



- Magnetic box with 8 compartments
- Waterproof joint to keep dry to products inside
- To be use with small and medium sizes of hooks, swivels or snaps

## MAGNETIC BOX 8C

Code	Gencod	RRP (€)
RG1421019		11,50

Trade Pack: x1

# BOXES

- Transparent and modular box
- Sealing seal
- Ideal for storing lures and small equipment
- Can be fixed on peg by plastic hanger



WATERPROOF BOX				
Code	Size	Specifications	Gencod	RRP (€)
RG1421001	27 x 18 x 4,8 cm	5 to 20 cases		12,15
Trade Pack: x1				



WATERPROOF BOX				
Code	Size	Specifications	Gencod	RRP (€)
RG1421002	35,5 x 22 x 5,5 cm	3 to 17 cases		17,45
Trade Pack: x1				



WATERPROOF BOX				
Code	Size	Specifications	Gencod	RRP (€)
RG1421003	35,5 x 22 x 8 cm	4 to 23 cases		19,40
Trade Pack: x1				



WATERPROOF BOX				
Code	Size	Specifications	Gencod	RRP (€)
RG1421006	35,5 x 22 x 8 cm	0 to 3 cases		18,40
Trade Pack: x1				

- Kit of 3 accessories boxes
- Keeps all your small accessories clean and dry
- 4 cases / 6 cases / 8 cases

ACCESSORIES BOXES KIT		
Code	Gencod	RRP (€)
RG1421000		7,30
Trade Pack: x1		



# BOXES



Its partition system in "V" keeps the lures always well accommodated. In addition to not allowing a wet lure to have contact with one that has not been used. It has small openings that allow the water from a used lure not to remain in the case, considerably reducing the oxidation of your hooks. It has a resistant double closure system and rubber handle.

LURES BOX			
Code	Size	Gencod	RRP (€)
RG1421009	28,5 x 19 x 5 cm vertical		10,30
RG1421010	20,5 x 17 x 4,8 cm vertical		9,15
RG1421011	20,5 x 17 x 4,8 cm horizontal		9,15

Trade Pack: x1



28,5 x 19 x 5 cm vertical



20,5 x 17 x 4,8 cm vertical



20,5 x 17 x 4,8 cm horizontal



Made of premium and high quality material with great resistance to impacts. It has a large lower compartment and 2 tilting ladder trays with 17 compartments and dividers, being effective to keep your equipment always well organized, a resistant and comfortable locking system when transporting.

BOX CONTAINER M			
Code	Size	Gencod	RRP (€)
RG1421013	36 x 21 x 19,5 cm		32,25

Trade Pack: x1



Made of premium and high quality material with great resistance to impacts. It has a large lower compartment and 3 tilting ladder trays with 27 compartments and dividers, being effective to keep your equipment always well organized, a resistant and comfortable locking system when transporting.

BOX CONTAINER L			
Code	Size	Gencod	RRP (€)
RG1421012	42 x 23 x 21 cm		41,50

Trade Pack: x1



# BOXES



Double compartment belt bait box, to keep your baits at your fingertips particularly useful when fishing standing-up or wading.

#### BELT BAIT BOX

Code	Size	Gencod	RRP (€)
RG1421018	27 x 10 x 9,5 cm		12,60

Trade Pack: x1



Box with different trays and compartments, can be placed on the belt and has a support to prevent it from tipping over.

#### BELT ACCESSORY BOX

Code	Size	Gencod	RRP (€)
RG1421014	20 x 15 x 18 cm		23,00

Trade Pack: x1



Double box with external openings, has clear covers that make it easy to quickly find any hook, float, lead or accessory, in addition to its 10 compartments that have a bottom with holes that make it easy to catch any hook, no matter how small. It is lightweight and compact, ideal to keep in your main bag or case.

#### BOX TRAY 2 SIDES

Code	Size	Gencod	RRP (€)
RG1421015	15 x 9 x 4,5 cm		4,55

Trade Pack: x1



Box with 6 departments in different sizes for all types of terminals and hooks, transparent cover that allows us to easily identify its content.

#### BOX TRAY 1 SIDE

Code	Size	Gencod	RRP (€)
RG1421017	12,2 x 9 x 2,5 cm		2,00

Trade Pack: x1



Double case, wallet type with 20 compartments and dividers with closing latch.



#### BOX TERMINAL TACKLE

Code	Size	Gencod	RRP (€)
RG1421016	12 x 10,5 x 3,5 cm		5,00

Trade Pack: x1



# AIR PUMPS



- Works with 1 LR20 battery (not included)
- Voltage 1,5 V / Autonomy 30 h / 1 speed
- Volume of air: 0,8 L / mn

#### AIR PUMP WITH ECO BATTERIES

Code	Gencod	RRP (€)
AWQ010139		12,60

Trade Pack: x1



- Works with 1 LR20 battery (not included)
- Voltage 1,5 V / Autonomy 30 h / 2 speed
- Volume of air: 0,8 L / mn

#### AIR PUMP WITH BATTERIES

Code	Gencod	RRP (€)
100900221		21,25

Trade Pack: x1



Sector 220 V. Flow rate: 2,5 l / min.

#### AIR PUMP WITH 1 EXIT ZONE

Code	Gencod	RRP (€)
150100221		21,40

Trade Pack: x1



Sector 220 V. Flow rate: 3l / min (1,5l per output)

#### AIR PUMP WITH 2 EXIT ZONE

Code	Gencod	RRP (€)
150200221		33,25

Trade Pack: x1



Rechargeable battery air pump + external battery for charging cell phones, flashlights...

#### MULTI-FUNCTIONAL AIR PUMP

Code	Gencod	RRP (€)
RG0600000		33,40

Trade Pack: x1

# AIR PUMPS



- Very Silent
- Low consumption
- In position 1 or 2, use up to 80 hours (30 hours for a normal model)
- 2 speeds.
- IP 44 Norm : Protection against splashing water in all directions (normal rain and humidity)
- Work with 1.5 V battery (not included)

#### AIR PUMP SAVING POWER

Code	Gencod	RRP (€)
RG0600001		24,90

Trade Pack: x1

**CAUTION: ALWAYS REMOVE THE BATTERIES WHEN USING A CIGAR LIGHTER PORT FOR OPERATION TO AVOID OVERHEATING BATTERIES AND CAST IRON.**



- Works with 1 LR20 battery (not included)
- Voltage 1,5 V / Autonomy 30 h / 1 speed
- Volume of air: 0,8 L / mn

#### AIR PUMP WITH CIGAR LIGHTER PLUG AND BATTERIES

Code	Gencod	RRP (€)
101000221		36,40

Trade Pack: x1

**CAUTION: ALWAYS REMOVE THE BATTERIES WHEN USING A CIGAR LIGHTER PORT FOR OPERATION TO AVOID OVERHEATING BATTERIES AND CAST IRON.**



- Operates with 2 LR20 batteries (not supplied).
- Voltage 3 V, autonomy 80 hours, weight 200 g.
- 220 V mains socket



with batteries

with battery charger



with cigar lighter

with 220V input

#### AIR PUMP 4 FUNCTIONS

Code	Gencod	RRP (€)
AWQ010011		62,85

Trade Pack: x1

# BUCKETS



## ROUND BUCKET WITH SIVE

Code	Size	Gencod	RRP (€)
AWQ140010	13 L		23,45
AWQ140011	18 L		31,35

Trade Pack: x1



## 7L BUCKET WITH SIVE

Code	Size	Gencod	RRP (€)
AWQ140009	7 L		18,70

Trade Pack: x1



## BUCKET + AERATOR

Code	Size	Gencod	RRP (€)
AWQ140022	7 L		36,05
AWQ140023	13 L		37,30

Trade Pack: x1

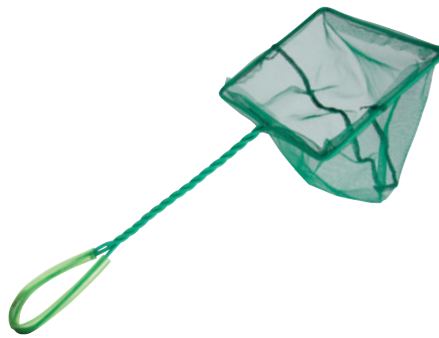

## POND NET

Code	Size	Gencod	RRP (€)
152700221	13 x 15		3,95

Trade Pack: x10

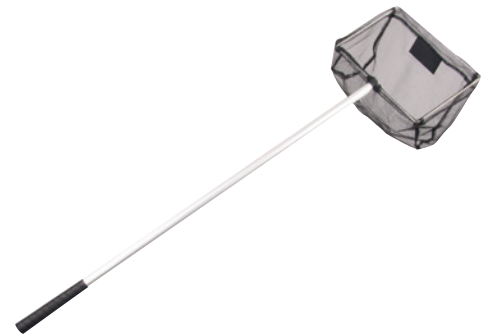

Livewell net with mesh in rubber to protect the mucus from fish.

## POND NET SOFT

Code	Size	Gencod	RRP (€)
AWQ180012	103 cm - Head 25 x 18 cm		12,60

Trade Pack: x1

# AIR PUMPS



## AIR PUMP SUCTION

Code	Gencod	RRP (€)
101100221		1,40

Trade Pack: x5



## SILICONE TUBE FOR AIR PUMP

Code	Gencod	RRP (€)
101200221		1,30

Trade Pack: x5



## TUBE + SUCTION

Code	Gencod	RRP (€)
AWQ010141		3,15

Trade Pack: x5

# ROLLER / ROD REST



## POLE V ROLLER SMALL

Code	Size	Gencod	RRP (€)
ARA370013	10 cm		8,45

Trade Pack: x1



## V ROLLER

Code	Size	Gencod	RRP (€)
AWQ370004	7,50 cm		8,45
AWQ370005	15 cm		10,55

Trade Pack: x1



Brilliant value pole roller with soft EVA to protect your sections, robust adjustable leg system that's fully folding for easy transportation. Width: 41,5 cm

## RAGOT ROLLER

Code	Size	Gencod	RRP (€)
RG3700013	Height mini : 27,5 / maxi : 43		39,90

Trade Pack: x1



- Adjustable height from 28 to 44 cm.
- Width between rolls : 32 cm.

## 4 LEG SINGLE POLE ROLLER

Code	Size	Gencod	RRP (€)
AWQ370006	Height mini : 28 / maxi : 44		39,50

Trade Pack: x1



- Support for rods kits
- 8 EVA positions
- Foldable and with adjustable legs

## 8 KITS SUPPORT

Code	Size	Gencod	RRP (€)
RG3700007	Height mini : 36 / maxi : 55		47,90

Trade Pack: x1



# ROD REST

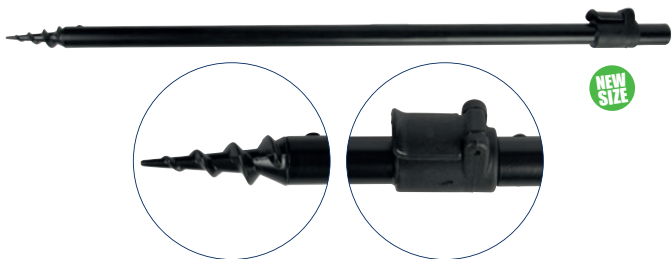

## ADJUSTABLE BLACK ALUMINIUM BANK STICK

Code	Size	Gencod	RRP (€)
RG3700010	0,75 / 1,20 m		8,50
AWQ370013	0,60 / 0,90 m		7,65

Trade Pack: x10

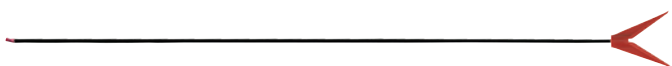

## SIMPLE ROD REST

Code	Size	Gencod	RRP (€)
972002221	0,75 m		4,70

Trade Pack: x5

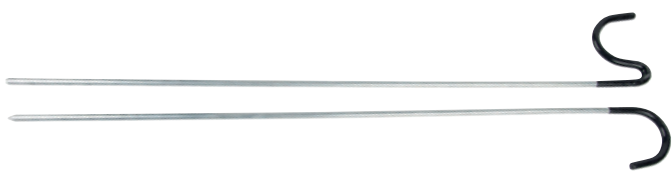

## OVER UNDER SUPPORT ROD RESTS

Code	Size	Gencod	RRP (€)
AWQ370016	0,70 m		8,00

Trade Pack: x5



## ADJUSTABLE ROD REST X2

Code	Size	Gencod	RRP (€)
AWQ370012	0,60 / 0,90 m		12,60

Trade Pack: x10



## TELESCOPIC V HEAD ROD REST

Code	Size	Gencod	RRP (€)
AWQ370008	0,45 / 0,70 m		4,50
AWQ370003	0,70 / 1,20 m		5,10

Trade Pack: x5



## TELESCOPIC BANK STICK

Code	Size	Gencod	RRP (€)
AWQ370015	0,65 / 1,10 m		6,15

Trade Pack: x5

NEW  
2024



## TELE ALU BANKSTCK V

Code	Size	Gencod	RRP (€)
RG3700011	0,70 / 1,10 m		3,90

Trade Pack: x5

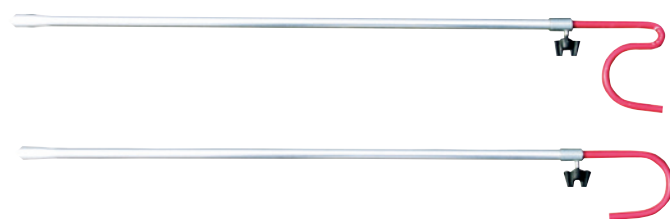

## ADJUSTABLE OVER UNDER SUPPORT ROD RESTS

Code	Size	Gencod	RRP (€)
973003221	0,65 to 1,00 m		12,75

Trade Pack: x5



## ALU BANKSTICK V HEAD

Code	Size	Gencod	RRP (€)
RG3700002	0,60 m		3,70
RG3700003	0,90 m		4,05

Trade Pack: x10



## VERTICAL SUPPORT ROD REST

Code	Size	Gencod	RRP (€)
AWQ010114	0,50 m		5,45

Trade Pack: x5



## TELESCOPIC ROD REST

Code	Size	Gencod	RRP (€)
106260221	0,60 / 0,80 m		16,30
106280221	0,80 / 1,20 m		17,70

Trade Pack: x1

# ROD REST

NEW  
2024



## PREDATOR BANK STICK

Code	Size	Material	Gencod	RRP (€)
RG3700012	70 cm	Steel		8,50

Trade Pack: x1



## ADJUSTABLE ROD REST COMPETITION

Code	Size	Gencod	RRP (€)
214000221	0,60 / 0,90 m		10,90

Trade Pack: x1



## ADJUSTABLE FIXED HEAD ROD REST

Code	Size	Gencod	RRP (€)
114100221	0,60 / 0,90 m		14,90

Trade Pack: x1



## METAL FOLDING ROD REST

Code	Gencod	RRP (€)
138500221		4,50

Trade Pack: x1



## PLASTIC FOLDING ROD REST

Code	Gencod	RRP (€)
142200221		3,00

Trade Pack: x1



## SCREW DOWN ROD REST

Code	Gencod	RRP (€)
103000221		8,80

Trade Pack: x1



## ADJUSTABLE ROD REST

Code	Gencod	RRP (€)
104220221		9,25

Trade Pack: x1



## DOUBLE STAKE ROD REST

Code	Gencod	RRP (€)
142300221		11,45

Trade Pack: x1



## TRIPOD

Code	Size	Gencod	RRP (€)
AWQ370001	0,52 - 0,80 m		30,40

Trade Pack: x1



## DOUBLE BANK STICK ROD REST

Code	Size	Gencod	RRP (€)
AWQ370002	0,53 - 0,86 m		20,80

Trade Pack: x1

# ROD REST



## ALUMINIUM BANK STICK

Code	Size	Gencod	RRP (€)
AA0038300	1 m		16,20
AA0038400	1,20 m		18,85
RG0321017	1,50 m		22,10

Trade Pack: x1

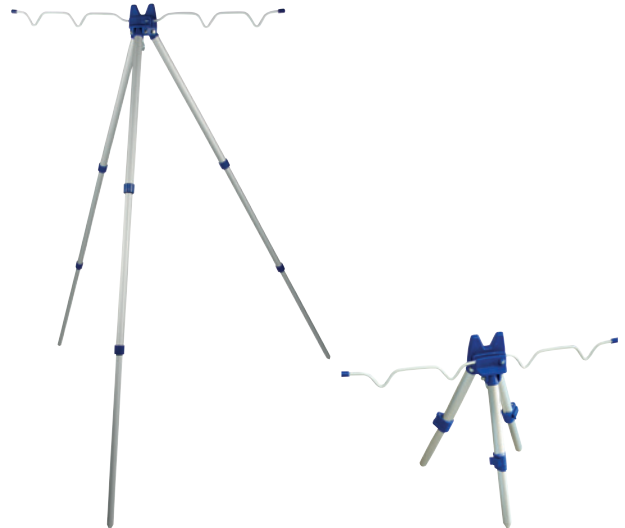

Adjustable: from 0,20 to 0,30 m for the small model, from 0,45 to 1 m for the big model.

## ROD TRIPOD

Code	Size	Gencod	RRP (€)
ATO370006	Large Model		26,80
ATO370007	Small Model		16,20

Trade Pack: x1



## ALUMINIUM BANK STICK - PHOSPHO - ADJUSTABLE

Code	Size	Color	Gencod	RRP (€)
ATO370005	1 m	Blue		15,40
ATO370002	1,25 m	Blue		17,95
RG3700009	1,50 m	Blue		19,90

Trade Pack: x1



- Aluminum construction.
- Supports of phosphorescent canes.
- Adjustable tilt.
- Very stable.
- Delivered in a transport bag.

## 2 ROD TRIPOD

Code	Gencod	RRP (€)
138600221		73,80

Trade Pack: x1

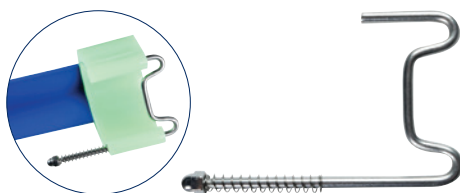

## SS CLIP SURF ROD

Code	Gencod	RRP (€)
RG3700008		1,90

Trade Pack: x1

# UMBRELLAS / KEEPNETS



## NYLON UMBRELLA

Code	Ø	Gencod	RRP (€)
108700221	2,20 m		39,90

Trade Pack: x1



## NYLON UMBRELLA WITH SURROUND

Code	Ø	Gencod	RRP (€)
108800221	2,20 m		59,90

Trade Pack: x1



## BROLY SPIKE



Code	Gencod	RRP (€)
108900221		8,00

Trade Pack: x1



- Floating Net to keep catch or live in good conditions.
- Large diameter top floating ring to hold the top of the net in place surface even largely stocked with live large sizes.
- Adjustable strap on the upper part to hang the net at the boat.
- Head equipped with a cord with a quick closing system.
- Metal rings at the top and bottom to limit thread compression when it is placed in the stream.
- In the lower part a ring and a pocket are available to hang a ballast.
- Once folded its size is reduced.

## FLOATING KEEPNET

Code	Ø	Size	Specifications	Gencod	RRP (€)
ATO080008	30 cm	45 cm	Medium model		20,70
ATO080009	57 cm	60 cm	Large model		27,95

Trade Pack: x1



## LACE UP KEEPNET

Code	Ø	Size	Gencod	RRP (€)
ATO080003	35 cm	60 cm		7,65

Trade Pack: x1



# KEEPNETS



Adjustable plastic head with a diameter of 35 cm

KEEPNET					
Code	Ø	Size	Specifications	Gencod	RRP (€)
AWQ080003	35 cm	1 m	Mesh 5 mm		10,30
248000230	35 cm	1,50 m	Mesh 5 mm		12,25
249000230	35 cm	2 m	Mesh 5 mm		13,40
RG0800004	35 cm	2,50 m	Mesh 5 mm		15,90

Trade Pack: x1



- Aluminum head.  
- Reinforced bottom.

CLASSIC RECTANGLE KEEPNET				
Code	Size	Specifications	Gencod	RRP (€)
018125233	1,80 x 0,40 x 0,31 m	Mesh 6 mm		29,25

Trade Pack: x1

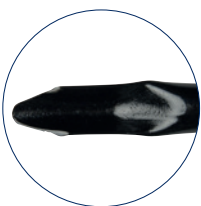

STEEL KEEPNET BANK STICK			
Code	Size	Gencod	RRP (€)
AWQ370014	75 cm		3,10

Trade Pack: x10

# KEEPNETS



- Adjustable Alu head
- Aluminium rings
- Reinforce mesh on the bottom



- Complete set composed:
- a hamper diameter 40 cm
  - a 35 cm aluminum spike
  - a hamper bag with carrying strap

## MATCH KEEP NET ROUND

Code	Ø	Size	Gencod	RRP (€)
RG0800005	50 cm	2 m		<b>24,90</b>
RG0800006	50 cm	2,50 m		<b>31,90</b>
RG0800007	50 cm	3 m		<b>39,90</b>

Trade Pack: x1

## FOLD AWAY KEEPNET & BAG

Code	Ø	Size	Gencod	RRP (€)
AWQ080005	40 cm	1,50 m		<b>27,95</b>

Trade Pack: x1



## ALUMINIUM KEEPNET BANK STICK

Code	Size	Gencod	RRP (€)
220011230	35 cm		<b>2,90</b>
220002230	75 cm		<b>4,00</b>

Trade Pack: x10



# KEEPNETS



## METAL ROUND BASKET NET

Code	Size	Specifications	Gencod	RRP (€)
023507981	Ø 25 cm Height 35 cm	Mesh 7 mm		12,85
023007981	Ø 30 cm Height 40 cm	Mesh 7 mm		14,95
023010981	Ø 30 cm Height 40 cm	Mesh 10 mm		13,40
023510981	Ø 35 cm Height 50 cm	Mesh 10 mm		15,15

Trade Pack: x1

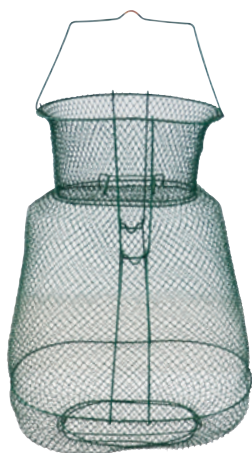

## RIGID METAL OVAL BASKET NET

Code	Size	Specifications	Gencod	RRP (€)
162001231	Depth 28 cm Width 40 cm Height 50 cm	Mesh 10 mm		20,25

Trade Pack: x1



## METAL OVAL BASKET NET

Code	Size	Specifications	Gencod	RRP (€)
024010982	Depth 28 cm Width 40 cm Height 50 cm	Mesh 10 mm		18,50

Trade Pack: x1

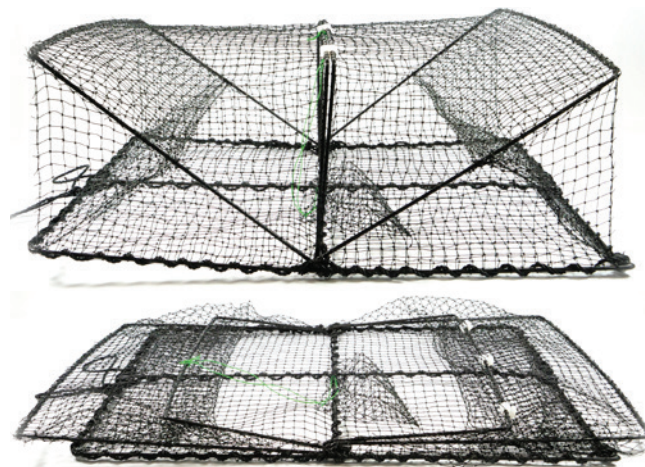

- Size (opened) : 61 x 44 x 22 cm
- Baits pocket
- Material : Mesh, PE
- Steel body
- Weight : 0,67 Kg

## FISH NET

Code	Gencod	RRP (€)
AWQ010149		22,40

Trade Pack: x1



## FOLDING FISH TRAP

Code	Size	Specifications	Gencod	RRP (€)
AWQ180010	0,25 x 0,25 x 0,48	Mesh 1,5 mm		9,95
AWQ080004	0,40 x 0,40 x 0,80	Mesh 1,5 mm		20,25

Trade Pack: x1



## PLAICE CARRIER

Code	Size	Gencod	RRP (€)
AE1016100	100 x 100 cm		15,40

Trade Pack: x1

# KEEPNETS



- Bait spring.
- Weighted scale.

SCALE NET				
Code	Ø	Specifications	Gencod	RRP (€)
063027201	27 cm	Mesh 27 mm		4,75
062014201	29 cm	Mesh 14 mm		6,05

Trade Pack: x6



- Comes with bait hook spring.

METAL SCALE NET				
Code	Ø	Specifications	Gencod	RRP (€)
163001231	30 cm	Mesh 10 mm		8,35

Trade Pack: x6



Special crayfish net kit including :

- 6 winders to wrap the cord and winders in blue color to easily find them in the grass.
- 30 meters of cord to cut (5 meters per scale).
- 6 floats to easily find the location of each net on the surface of the water.

## CRAYFISH NET KIT X 6

Code	Gencod	RRP (€)
RG0800003		11,45

Trade Pack: x1

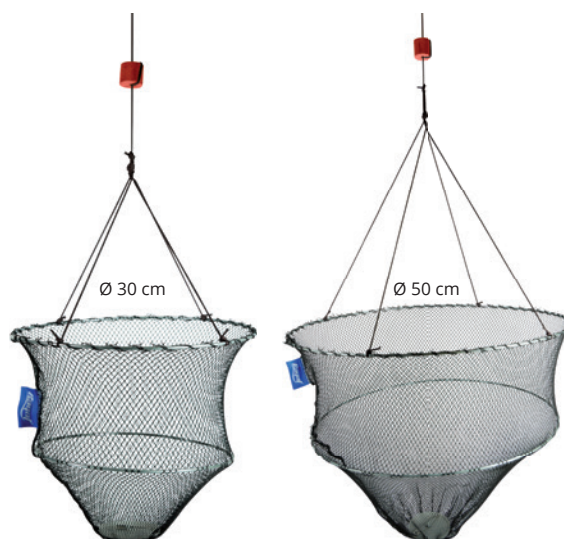

- Steel rings:  
Small, 30 cm on top and 25 cm on bottom  
Large, 50 cm on top and 45 cm on bottom
- 6 mm mesh
- Door bait with pin and lead
- 4 metre rope equipped with a float

## SHRIMPS NET

Code	Ø	Specifications	Gencod	RRP (€)
RG7021000	30 cm	Polyester mesh & rope		8,35
RG7021001	50 cm	Polyester mesh & rope		11,90

Trade Pack: x5



## THREAD HEAD ADJUSTABLE SCALE HANDLE

Code	Size	Gencod	RRP (€)
064001201	2,5 m		27,95

Trade Pack: x1



# NETS



- 2 elements
- Folding head net
- Telescopic aluminum handle

## HOBBY NET

Code	Size	Specifications	Gencod	RRP (€)
AWQ180038	103 to 150 cm - Head 40 x 40 cm - Depth 40 cm	Mesh 3 mm		12,85
AWQ180039	133 to 200 cm - Head 50 x 50 cm - Depth 50 cm	Mesh 3 mm		15,15
AWQ180040	160 to 250 cm - Head 60 x 60 cm - Depth 60 cm	Mesh 3 mm		17,80

Trade Pack: x1

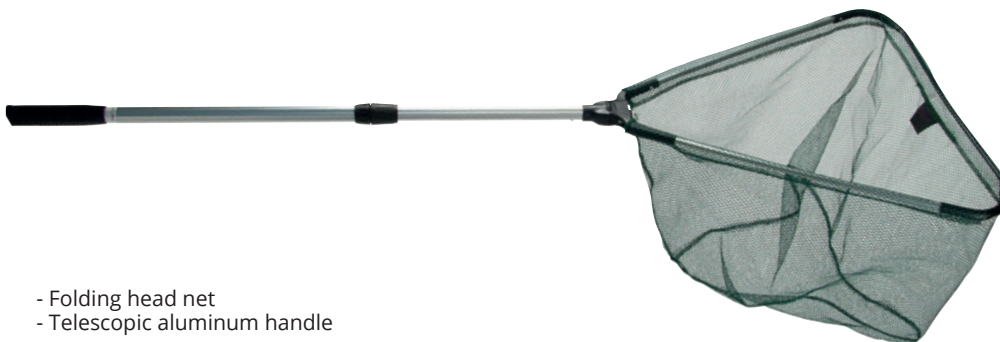

- Folding head net
- Telescopic aluminum handle

## ALL ROUND

Code	Size	Specifications	Gencod	RRP (€)
087000200	0,80 m - Head 40 x 40 cm - Depth 30 cm	1 piece Mesh 5 mm		12,60
088000200	1,50 m - Head 50 x 50 cm - Depth 30 cm	2 pieces Mesh 5 mm		20,25
089000200	2,10 m - Head 60 x 60 cm - Depth 40 cm	2 pieces Mesh 5 mm		25,30
RG1818017	2,70 m - Head 65 x 65 cm - Depth 50 cm	3 pieces Mesh 5 mm		28,90

Trade Pack: x1



- Folding head net
- Telescopic aluminum handle.
- Special mesh that preserves mucus fish and allows it to be released in excellent conditions.
- Belt clip.

## GERARDMER

Code	Size	Specifications	Gencod	RRP (€)
RG1818018	100 cm - Head 43 x 40 cm - Depth 30 cm	1 pieces Mesh 10 x 5 mm		36,90
RG1818019	107 to 145 cm - Head 50 x 50 cm - Depth 40 cm	2 pieces Mesh 10 x 5 mm		39,90
RG1818020	125 to 185 cm - Head 50 x 50 cm - Depth 40 cm	2 pieces Mesh 10 x 5 mm		44,90
RG1818021	155 to 235 cm - Head 60 x 60 cm - Depth 50 cm	2 pieces Mesh 10 x 5 mm		48,90
RG1818022	160 to 310 cm - Head 60 x 60 cm - Depth 50 cm	3 pieces Mesh 10 x 5 mm		56,90
AWQ180013	75 to 170 cm - Head 50 x 50 cm - Depth 40 cm	2 pieces Mesh 10 x 5 mm		41,90

Trade Pack: x1

# NETS

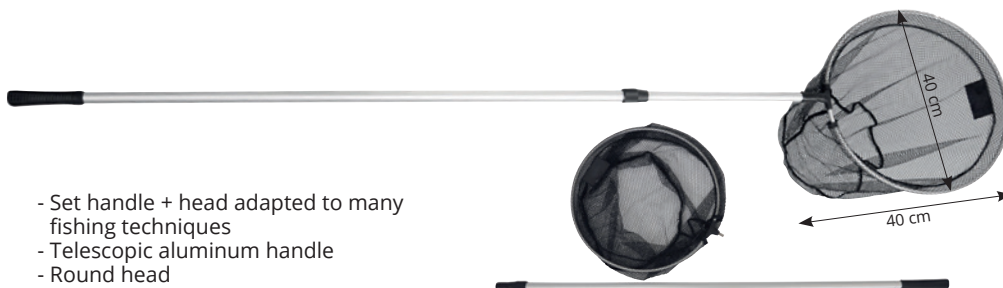

- Set handle + head adapted to many fishing techniques
- Telescopic aluminum handle
- Round head

## ROUND HEAD

Code	Size	Specifications	Gencod	RRP (€)
AWQ180001	145 to 280 cm - Head 40 x 40 cm - Depth 40 cm	Mesh 6 mm		30,40

Trade Pack: x1

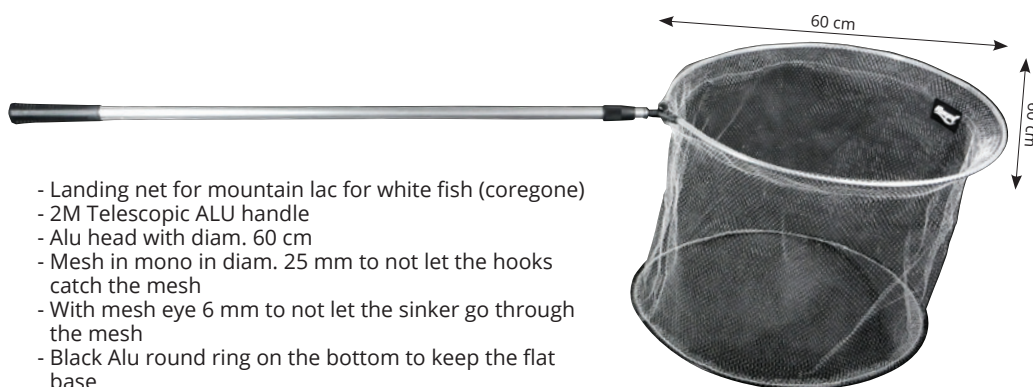

- Landing net for mountain lac for white fish (coregone)
- 2M Telescopic ALU handle
- Alu head with diam. 60 cm
- Mesh in mono in diam. 25 mm to not let the hooks catch the mesh
- With mesh eye 6 mm to not let the sinker go through the mesh
- Black Alu round ring on the bottom to keep the flat base

## LEMAN

Code	Size	Specifications	Gencod	RRP (€)
RG1818023	270 cm max - Head : 60 x 60 cm - Depth : 50 cm	Mesh 6 mm		39,90

Trade Pack: x1



This landing net model is very versatile, it can be used fishing for many disciplines from bank or by boat. Its generous dimensions are enough to scoop many species. Its telescopic aluminum handle in 2 elements is very resistant and allows to adapt to all situations. This net is very resistant thanks to its handle and its aluminum head. It is equipped with a rubberized mesh net for greater respect for fish and faster drying to avoid bad smells in the trunk of the car!

## VERSATILE LANDING NET

Code	Size	Specifications	Gencod	RRP (€)
RG1818008	250 cm max - Head : 60 x 60 cm - Depth : 60 cm	Mesh 10 mm		40,35

Trade Pack: x1

# NETS



- Telescopic aluminum handle.
- Removable head 55x40 cm

ECO NET				
Code	Size	Specifications	Gencod	RRP (€)
AWQ180041	153 to 225 cm - Head 55 x 40 cm - Depth 45 cm	Mesh 5 mm		<b>18,60</b>

Trade Pack: x1

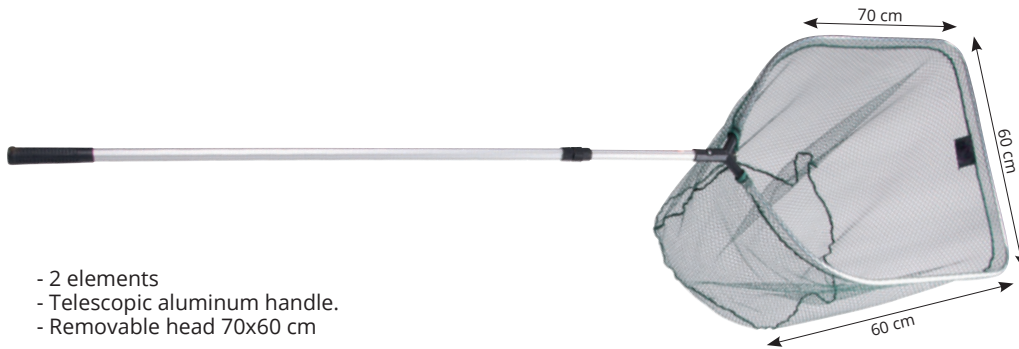

- 2 elements
- Telescopic aluminum handle.
- Removable head 70x60 cm

ECO NET LARGE				
Code	Size	Specifications	Gencod	RRP (€)
AWQ180022	185 to 270 cm - Head 70 x 60 cm - Depth 60 cm	Mesh 10 mm		<b>32,95</b>

Trade Pack: x1



- Aluminium handle.
- Telescopic.
- Extends by turning 1/4 turn to the left.
- For use with a screw head.

LANDING NET HANDLE			
Code	Size	Gencod	RRP (€)
AWQ180009	3 m max		<b>19,55</b>

Trade Pack: x1



- Telescopic landing net handle.
- HR fiber, 3 meters.
- Aluminum head.

PRO MATCH 300			
Code	Size	Gencod	RRP (€)
076300201	3 m max		<b>21,50</b>

Trade Pack: x1



# GAFF / HEADS



- Robust floating gaff.
- 3 EVA handles.
- 316 stainless steel hook.

FLOATING ADJUSTABLE GAFF			
Code	Size	Gencod	RRP (€)
ATO180004	1,50 m		36,75

Trade Pack: x1



- Telescopic aluminum handle.
- Belt clip
- Fixed stainless steel hook with plastic protector

GAFF			
Code	Size	Gencod	RRP (€)
AWQ180004	75 to 140 cm		21,75
AWQ180005	120 to 220 cm		27,95

Trade Pack: x1



Nylon net head with a super strong frame.

CLASSIC MATCH				
Code	Size	Specifications	Gencod	RRP (€)
078000201	Head 45 x 40 cm Depth 30 cm	Mesh 5 mm		11,80

Trade Pack: x1

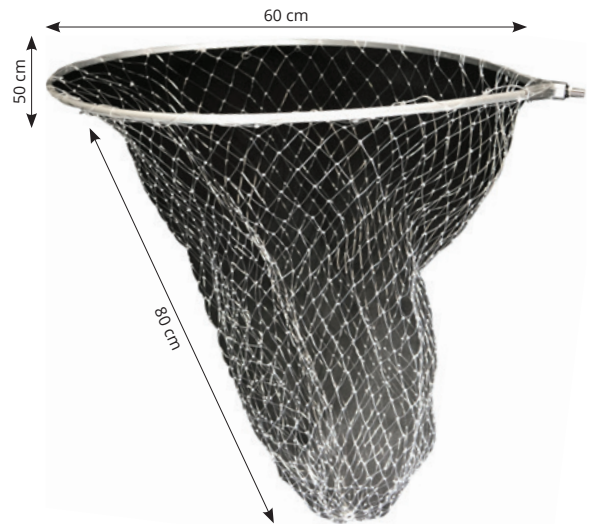

- Net Head with a very strong Alu Frame.
- Specially designed for sea fishing.
- Reinforced nylon mesh.
- Built using a standard thread, can be used with most landing net handles of the market.

ALU HEAD OVAL SPECIAL SEA				
Code	Size	Specifications	Gencod	RRP (€)
RG1818024	Head 60 x 50 cm Depth 80 cm	Mesh : 5 cm		21,90

Trade Pack: x1



# RACKET

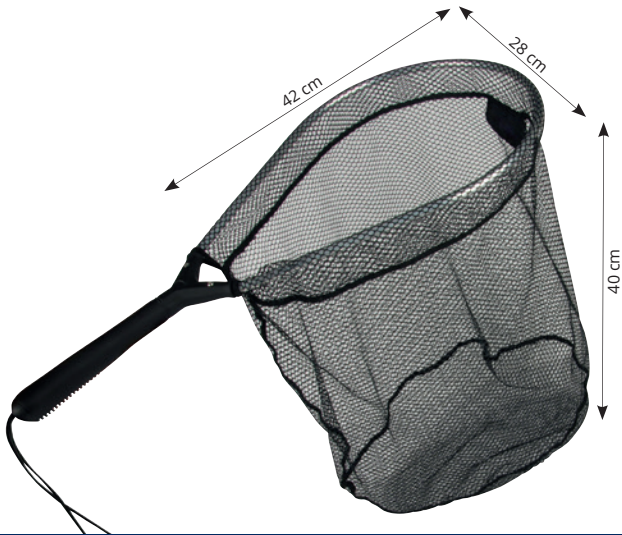

## RACKET NET

Code	Size	Specifications	Gencod	RRP (€)
AWQ180033	Head 42 x 28 cm Length 60 cm Depth 40 cm	Mesh 5 mm		10,90

Trade Pack: x1



## ARTI

Code	Size	Specifications	Gencod	RRP (€)
033900201	Head 40 x 33 cm Length 54 cm Depth 60 cm	Mesh 6 mm		21,90

Trade Pack: x1



## RUBBER MESH

- Floating Racket specially designed for trout fishing, light with a short handle
- Laminated mesh to not hurt the fish
- Provided with elastic and carabiner.

## RACKET PRO FLY NET

Code	Size	Specifications	Gencod	RRP (€)
020590201	Head 42 x 28 cm Length 60 cm Depth 35 cm	Mesh 6 mm		26,50

Trade Pack: x1

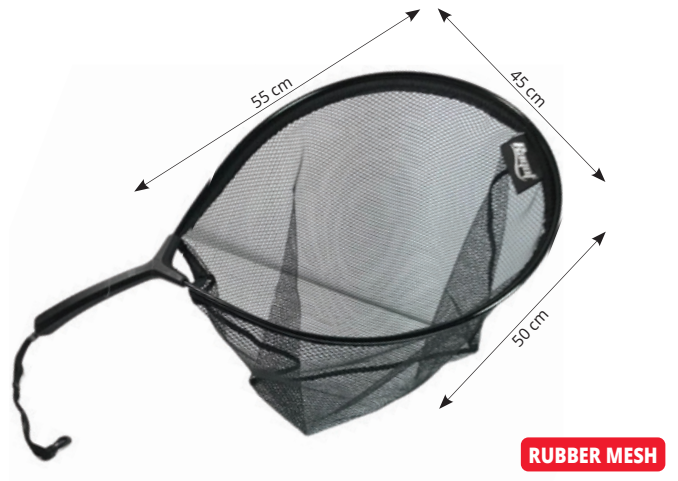

## RUBBER MESH

- Floating Racket specially designed for float tube/kayak, light with a short handle
- Laminated mesh to not hurt the fish
- Provided with elastic and carabiner.

## FLOATING RACKET NET

Code	Size	Specifications	Gencod	RRP (€)
AWQ180032	Head 55 x 45 cm Length 75 cm Depth 50 cm	Mesh 6 mm		28,80

Trade Pack: x1

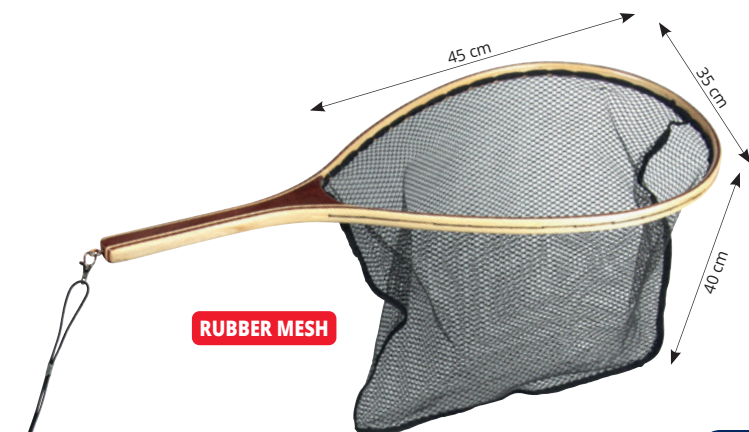

## RUBBER MESH

Soft Mesh to protect fish mucus and general fish welfare.

## WOODEN RACKET NET LARGE

Code	Size	Specifications	Gencod	RRP (€)
AWQ180042	Head 45 x 35 cm Length 60 cm Depth 40 cm	Mesh 8 x 5 mm		35,50

Trade Pack: x1

# RACKET

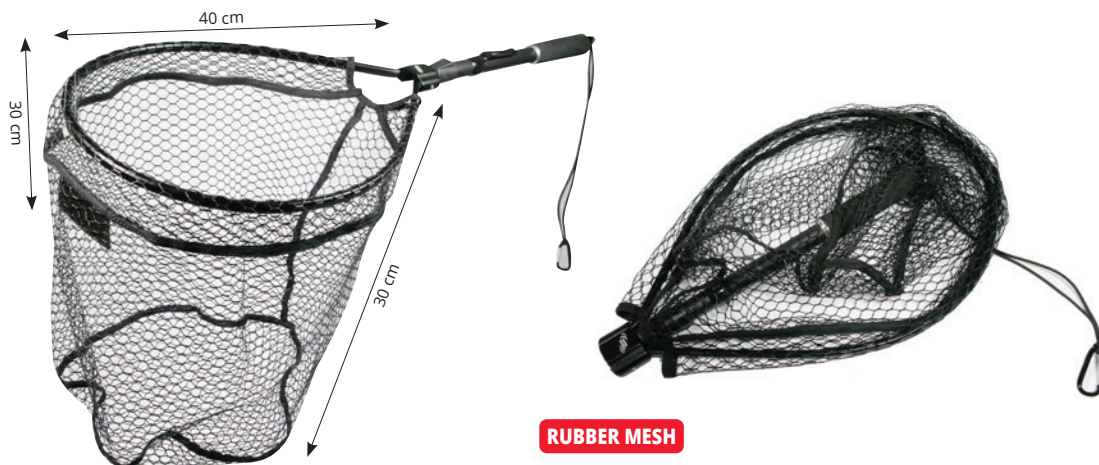

**RUBBER MESH**

This landing net, designed for trout fishing can be hung in the back, on the jacket or on the vest using a magnet. This one is more versatile than a classic trout net since it has a longer handle which is particularly convenient when it is not possible to fish in the water or it is necessary to exhaust a fish from the top of a low wall. As such, it is also ideal for streetfishing above the docks. The handle folds over the head to reduce the clutter, so that it is forgotten in the back of the fisherman in fishing action. The opening system is very convenient and can be handled with one hand to dry your sockets safely. The rubber net allows a better respect of the fish and a faster drying to avoid bad smells in the trunk of the car! The handle ends with a magnet and a long elastic to secure the dip net during the fishing game.

GOUMOIS				
Code	Size	Specifications	Gencod	RRP (€)
RG1818012	Handle : 30 cm - Head : 40 x 30 cm - Depth : 30 cm	Mesh : 12 mm		28,80

Trade Pack: x1

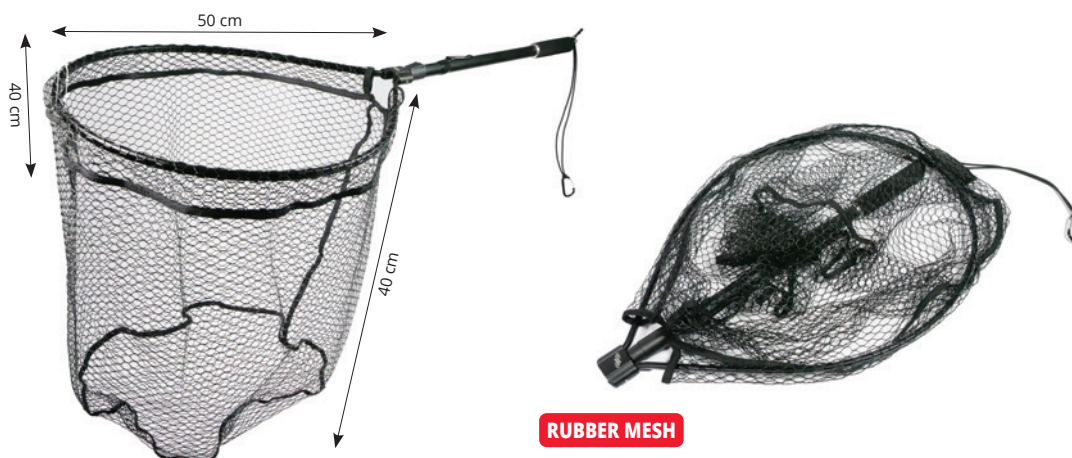

**RUBBER MESH**

Same characteristics as the Goumois, this one simply offers more generous dimensions for the landing of large trout and other large predatory species (pike, sandres, perch, aspes ...).

ORNANS				
Code	Size	Specifications	Gencod	RRP (€)
RG1818013	Handle : 50 cm - Head : 50 x 40 cm - Depth : 40 cm	Mesh : 12 mm		34,55

Trade Pack: x1





# NETS

Range of RAGOT landing nets developed with our TEAM for Sea fishing. Handle and head in Aluminum. Recognizable by an anodized coating of blue color and which in addition will serve as a protective film against the oxidation of sea spray. 2 models are available and will satisfy more than one fisherman whether from bank or by boat. BREHAT model is equipped with a fixed handle. HOUAT model with a telescopic handle in 2 elements. A very clever system allows to lock and unlock the net head on the handle simply by rotating the latter and those very quickly. This range of dip nets has been designed and tested by us for a full year! Handle, shape, length, quality, lightness, choice of materials, coating or depth of the net everything has been thought out in order to offer you an ergonomic and finished product! This new range of dip net will ensure your catch in complete serenity!

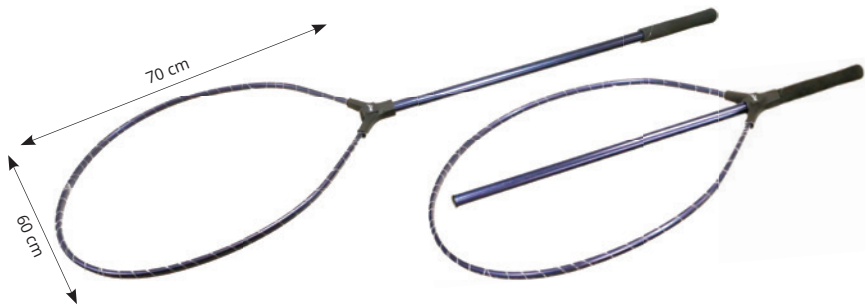

BREHAT				
Code	Size	Specifications	Gencod	RRP (€)
RG1818015	Handle : 90 cm - Head : 70 x 60 cm - Depth : 90 cm	Mesh Nylon 30 mm		51,90
Trade Pack: x1				



HOUAT				
Code	Size	Specifications	Gencod	RRP (€)
RG1818016	Handle : 100 - 170 cm - Head : 70 x 60 cm - Depth : 90 cm	Mesh Nylon 30 mm		61,10
Trade Pack: x1				



Aluminum telescopic handle in 2 elements. Floating net thus no risk of loss if it falls in the water when fishing by boat. Removable head, special mesh and laminated.

FLOATING LANDING NET			
Code	Size	Gencod	RRP (€)
RG7018007	Mini 1,3 m - Maxi 2 m - Head : 40 x 30 cm		48,90
Trade Pack: x1			



Aluminum telescopic handle. Round head. Color blue

TELESCOPIC BEACH NET					
Code	Ø	Size	Specifications	Gencod	RRP (€)
ATO700001	25 cm	75 to 120 cm	Depth : 20 cm		12,50
Trade Pack: x1					



Plastic handle. Round head. Colors: Orange / Green / Yellow / Blue.

ROUND BEACH NET					
Code	Ø	Size	Specifications	Gencod	RRP (€)
PAP144000	25 cm	105 cm	Depth : 20 cm		5,45 per unit
Trade Pack: x1 (5 per packet)					

# BAGS

- Eco Version for Combos for Predator or Tele Sea Combo
- Zipp head + zipper puller in Zinc Alloy – for freshwater and sea use.



**PREDATOR LUGGAGE 2 RODS ECO**

Code	Gencod	RRP (€)
RG0700023		31,00

Trade Pack: x1



**PREDATOR LUGGAGE 3 RODS ECO**

Code	Gencod	RRP (€)
RG0700024		40,00

Trade Pack: x1



**PREDATOR LUGGAGE 4 RODS ECO**

Code	Gencod	RRP (€)
RG0700025		49,00

Trade Pack: x1



# BAGS

PLASTIC ZIP FOR FRESHWATER AND SEA USE



Simple cover for rod + reel.

### SINGLE ROD HOLDALL

Code	Gencod	RRP (€)
RG0700004		18,00

Trade Pack: x1

- 2 Rod Holdall landing net case
- Side pocket
- 2 long straps for transport

### 2 COMPARTMENT ROD HOLDALL

Code	Gencod	RRP (€)
RG0700005		46,00

Trade Pack: x1



# BAGS

PLASTIC ZIP FOR FRESHWATER AND SEA USE



- 2 Rod Holdall landing net case
- Side pocket
- 2 long straps for transport

### 3 COMPARTMENT ROD HOLDALL

Code	Gencod	RRP (€)
RG0700006		58,00

Trade Pack: x1



- 2 Rod Holdall landing net case
- Side pocket
- 2 long straps for transport

### 4 COMPARTMENT ROD HOLDALL

Code	Gencod	RRP (€)
RG0700007		65,00

Trade Pack: x1



# BAGS



**PLASTIC ZIP FOR FRESHWATER AND SEA USE**



Designed to hold 3 telescopic rods and mounted with reels.  
 - 3 separate and padded compartments.  
 - 2 outdoor fixations for surf pikes or dip net.  
 - Adjustable strap.  
 - Carrying handle.

1 compartment for Rod + Reel or match rod.  
 - 1 compartment for pole rods  
 - 1 side pocket of 85 cm.  
 - 2 long straps for transport.

TELESCOPIC COMPACT ROD HOLDALL		
Code	Gencod	RRP (€)
RG0700008		65,00

Trade Pack: x1

GENERAL ROD HOLDALL		
Code	Gencod	RRP (€)
RG0700009		46,00

Trade Pack: x1

Bag with 3 boxes  
 - plastic resistant to soft lures and provided for storing accessories or lures.



23 x 16 x 16 cm

3 BOX MULTI USE BAG		
Code	Gencod	RRP (€)
RG0700012		28,00

Trade Pack: x1



- Adjustable strap.  
 - Ideal for fast fishing.  
 - Lightweight and space-saving.



22,5 x 19 x 18 cm

4 BOX MULTI USE BAG		
Code	Gencod	RRP (€)
RG0700013		33,00

Trade Pack: x1





# BAGS



22 x 40 x 20 cm



Carryall including 4 plastic boxes ideal for storing accessories and lures. Suitable for either Freshwater or Saltwater fishing.

- Front pocket.
- 2 side pockets.
- Adjustable strap.
- Light and space-saving.
- Carrying handle and adjustable strap.

LURES BAG + 4 BOX		
Code	Gencod	RRP (€)
RG0700014		59,00
Trade Pack: x1		



Sling Bag offering great freedom of movement while fishing.

- Allows quick and easy access to its lures or accessories.
- Fish bag detachable and washable.
- Inside pocket for keys.
- 2 front pockets with zip.

MUSETTE TRACKER		
Code	Gencod	RRP (€)
RG0700017		25,90
Trade Pack: x1		

**PLASTIC ZIP FOR FRESHWATER AND SEA USE**



Adjustable strap.

- Large central pocket.
- Fish bag detachable and washable.
- 2 front pockets.



30 x 37 x 11 cm



31 x 42 x 15 cm

MUSETTE		
Code	Gencod	RRP (€)
RG0700015		28,00
Trade Pack: x1		



MUSETTE		
Code	Gencod	RRP (€)
RG0700016		29,90
Trade Pack: x1		





# BAGS



- Perfect basket for fishing time.
- Large opening on top for easy sliding his catch.
- 3 front pockets with zip.
- Adjustable strap.

21 x 33 x 17 cm

### 3 POUCH BASKET GREEN

Code	Gencod	RRP (€)
AWQ070017		19,90

Trade Pack: x1



21 x 33 x 17 cm

### 3 POUCH BASKET CAMO

Code	Gencod	RRP (€)
RG0700019		21,90

Trade Pack: x1

# TUBES



### ROD TUBE

Code	Ø	Size	Gencod	RRP (€)
208000260	40 mm	160 cm		9,05
209000260	50 mm	180 cm		10,85
210001260	60 mm	190 cm		13,90

Trade Pack: x1



### ROD TUBE - OVAL

Code	Ø	Size	Gencod	RRP (€)
211002260	-	175 cm		15,00

Trade Pack: x1



### ROD TUBE - HEXAGONAL

Code	Ø	Size	Gencod	RRP (€)
ARA070031	60 mm	190 cm		14,50

Trade Pack: x1

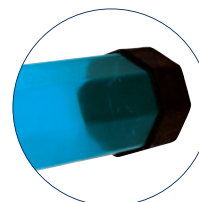

# SALTWATER BAGS



- For maximum protection of surf-casting rods non mounted
- Padded mesh material
- 3 individual channels
- 1 model with 2 velcros to accept rods in 4,20 and in 4,50m

## ROD MESH BAG

Code	Size	Gencod	RRP (€)
RG0700027	165 x 15 cm		21,50

Trade Pack: x1



- Luggage specially designed for fishing in Surf-casting. Intended to receive 3 telescopic or rods sections, and mounted with the reels. 3 separate and padded compartments. Exterior fasteners by velcro for surf spades or dip net. Adjustable strap. Carrying handle.

## SURF / BOAT PADDED 3 ROD HOLDALL

Code	Size	Gencod	RRP (€)
RG0700021	30 x 32 x 160 cm		69,00

Trade Pack: x1



Fully waterproof bags with heat welded seam construction throughout. The tops are secured by a rollover and buckle clip design, you can be sure that water won't get inside. Perfect for protecting valuable items such cell phones, electronics and wallets from water and humidity. They are also great for spare clothes or food. Easily carried with the shoulder strap that's included. 2 Sizes: 10 & 30L

## DRY BAG

Code	Specifications	Gencod	RRP (€)
RG0700028	10 Liters		11,90
RG0700029	30 Liters		19,90

Trade Pack: x1



- Coolers to keep your food, drinks or bait cool.
- Reinforced thermal insulation.
- Folding handle light and compact.

## COOLER

Code	Size	Specifications	Gencod	RRP (€)
ATO070017	27 x 21 x 18 cm	5 Liters		24,90
ATO070018	30,5 x 23 x 25 cm	8,20 L		31,95

Trade Pack: x1



# SALTWATER BAGS

High level Bakkan made from 1.5 mm EVA with a moulded reinforced lid and base for added protection, combined with welded seams and clip lock system. Designed to accept lure boxes and keep them 100% dry. Large plastic zips making the bag ideal for both freshwater and saltwater fishing, from a boat or on the bank. Additionally, for easy access, the bag also has a magnet system. The Bakkan is easily carried, either by the hand carry handles or by the adjustable shoulder strap. Volume: 26L



BAKKAN 3K				
Code	Size	Gencod	RRP (€)	
RG0700033	41 x 26 x 25 cm		69,90	

Trade Pack: x1

A pouch to be used inside the Bakkan for storing plastic boxes, accessories, licence, phone, keys etc. Made from 1.5 mm EVA and using a plastic zip, the pouch will keep the contents dry and safe when fishing either freshwater or saltwater. Finished with a strong PVC carry handle and a transparent lid to easily see the items inside.

POUCH 3K				
Code	Size	Gencod	RRP (€)	
RG0700034	40 x 26 x 5 cm		22,90	



Trade Pack: x1



The Bakkan Ragot is a multipurpose waterproof bag with a zippered lid and a watertight bottom. It is the ideal container to protect material from external moisture. It accepts up to 4 boxes RAGOT RG1421002 (boxes not provided). Being waterproof, bakkan Ragot can also be used as a raw bucket or as a rescue pond. Reinforced handles and carrying strap.



## WATERPROOF ACCESSORY BAG

Code	Size	Specifications	Gencod	RRP (€)
RG0700001	26 x 25 x 41 cm	25 Liters		24,90
RG0700030	36,5 x 24 x 21 cm	16 Liters		19,90

Trade Pack: x1



A BAKKAN with four clear and detachable dividers, to keep the lures separate and not mix the hooks. Made from EVA and using a plastic zip to keep the content dry and protected when fishing either freshwater or saltwater. Finished with an adjustable and detachable belt strap, plus a transparent lid to easily see the lures inside.

BAKKAN				
Code	Size	Specifications	Gencod	RRP (€)
RG0700031	24 x 15 x 17 cm	5 Liters		24,90

Trade Pack: x1



A BAKKAN with six clear and detachable dividers, to keep the lures separate and not mix the hooks. Made from EVA and using a plastic zip to keep the content dry and protected when fishing either freshwater or saltwater. Punched holes on the underneath side to help evacuate water. Finished with an adjustable and detachable shoulder strap, plus a transparent lid to easily see the lures inside.

BAKKAN SPECIAL LURES				
Code	Size	Specifications	Gencod	RRP (€)
RG0700032	24 x 21,5 x 17 cm	6,50 Liters		39,90

Trade Pack: x1

# TROLLEYS



- Folding design for easy storage.
- Handle adjustable in height.
  - Steel frame.
  - Inflatable wheels.

FISHING TROLLEY COMPACT		
Code	Gencod	RRP (€)
141500221		69,00

Trade Pack: x1

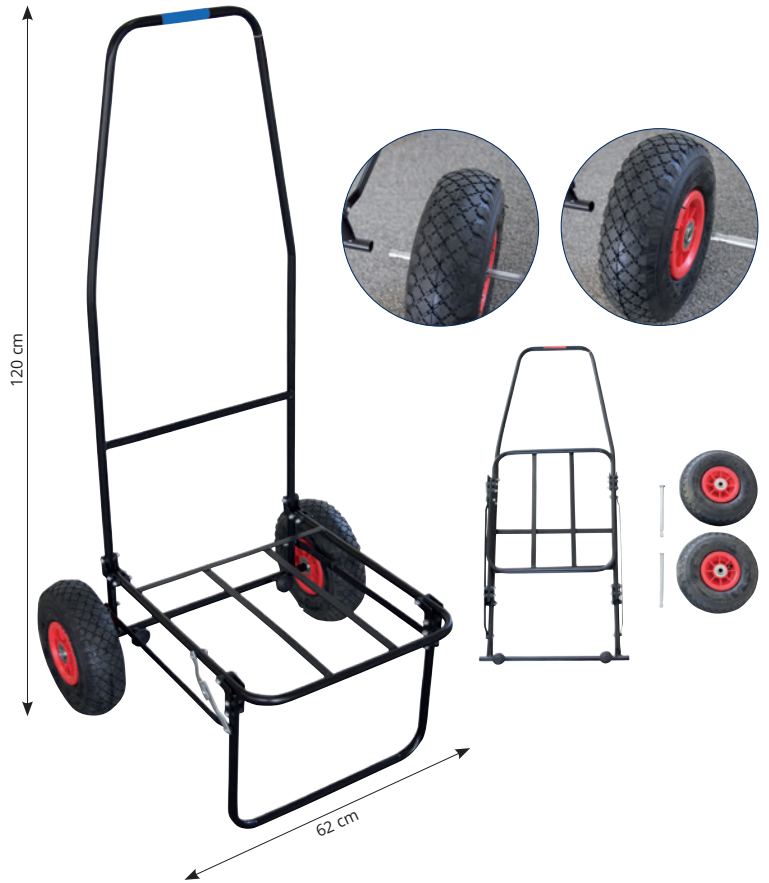

Steel structure. Inflatable wheels.

FISHING TROLLEY		
Code	Gencod	RRP (€)
120400221		65,00

Trade Pack: x1



SPARE WHEEL		
Code	Gencod	RRP (€)
ARA010036		13,00

Trade Pack: x1

- Folding design for easy storage.
- Handle adjustable in height.
- Aluminium frame.
- Inflatable wheels.

ALUMINIUM FISHING TROLLEY		
Code	Gencod	RRP (€)
ATO700005		109,00

Trade Pack: x1

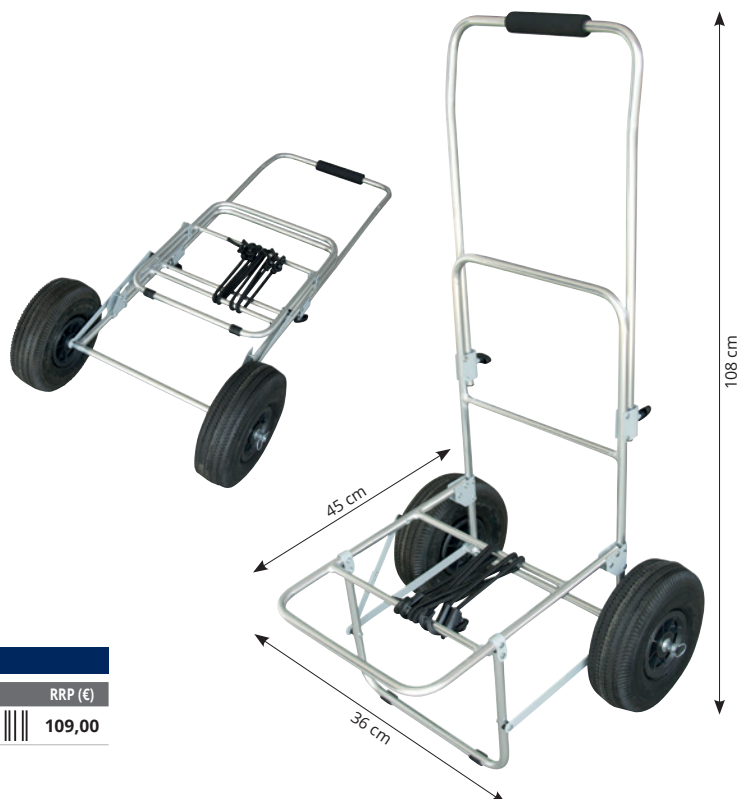



# SEATS



A super comfortable padded folding chair with armrests, made from 600D Oxford Nylon and a super strong steel. Suitable for many types of fishing and outdoor use. Supplied with a carry case for easy transportation.  
Max Loading weight: 150 kg

## CONFORT CHAIR XL

Code	Size	Gencod	RRP (€)
RG2100007	105 x 65 x 54 cm		79,90

Trade Pack: x1



- Folding chair ideal for fishing or camping.
- Very comfortable and stable.
- Reduced footprint once folded.
- Steel structure maximum load 110 kg

## CINEMA CHAIR

Code	Size	Gencod	RRP (€)
RG2100001	86 x 48 x 46 cm		65,00

Trade Pack: x1



- This seat will allow you to relax comfortably at the water's edge.
- Very small footprint.
- Delivered in a transport bag.

## FOLDING CHAIR

Code	Size	Gencod	RRP (€)
AWQ070018	80 x 50 x 40 cm		27,90

Trade Pack: x1



- Lightweight seat with folding backrest.
- Very fast set-up.
- Steel structure.
- Maxi load 100 kg

## DECK CHAIR

Code	Gencod	RRP (€)
RG2100003		19,90

Trade Pack: x1



- Lightweight seat.
- Very fast set-up.
- Steel structure.
- Maxi load 100 kg

## COMPACT FOLDING SEAT

Code	Gencod	RRP (€)
RG2100002		14,90

Trade Pack: x1



- Lightweight seat.
- Very fast set-up.
- For fishing or hunting.
- Steel structure.
- Maximum load 100 kg.

## TRIPOD CHAIR

Code	Gencod	RRP (€)
RG2100004		14,90

Trade Pack: x1

# SEATS



- Lightweight seat with folding backrest.
- Very fast set-up.
- Rod support under the seat, steerable possible by 2 positions.
- Steel structure.
- Maximum load 100 kg.

ROD REST CHAIR		
Code	Gencod	RRP (€)
RG2100005		34,90

Trade Pack: x1



- The backpack will allow you to store all your accessories or food.
- Lightweight seat.
- Very fast set-up.
- Steel structure.
- Maximum load 100 kg.

SEAT + BAG		
Code	Gencod	RRP (€)
RG2100006		49,90

Trade Pack: x1

A range of seat baskets suitable for the whole family for catch fishing. Aluminum housing, plastic drawers, inner tank with primer and adjustable strap.



38 x 32 x 26 cm

SEAT BOX 1 TRAY		
Code	Gencod	RRP (€)
AWQ070025		69,00

Trade Pack: x1



41 x 32 x 26 cm

SEAT BOX 2 TRAY		
Code	Gencod	RRP (€)
AWQ070031		79,00

Trade Pack: x1



45 x 32 x 26 cm

SEAT BOX 3 TRAY		
Code	Gencod	RRP (€)
AWQ070026		89,00

Trade Pack: x1

**NEW  
2024**

# CLOTHES



Lightweight fabric that dries quickly and is easy to wash.  
Mesh lining makes it very comfortable to wear including by strong heat.  
Padded neckband for maximum comfort.  
6 pockets on the front to store boxes and small fishing equipment.  
2 staples with extendable drawstring for easy cutting tools wire, fly dry or clamp.  
2 inside pockets including one equipped with a waterproof pouch to store the telephone and fishing license.  
Dorsal eye on the top to fix the racket.  
Large back pocket.  
The zippers are equipped with cords to open and close pockets easily.  
This vest is suitable for all itinerant fishing, whether lures, fly or toc.  
It will allow you to take with you, in an optimal comfort, all the necessary for a successful fishing trip.

4 POCKET FISHING VEST			
Code	Size	Gencod	RRP (€)
RG6800007	M		39,90
RG6800008	L		39,90
RG6800009	XL		39,90
RG6800010	XXL		39,90

Trade Pack: x1



# CLOTHES



- Material 65% polyester + 35% cotton.
- Neck protection.
- 12-pockets : 8 front pockets, 3 inside pockets (1 waterproof to store mobile or fishing license) and 1 back pocket.
- Dorsal part ventilated.
- Excellent value for all fisheries with lures or lapping.

## WADDING FISHING VEST

Code	Size	Gencod	RRP (€)
RG6800011	M		39,90
RG6800012	L		39,90
RG6800013	XL		39,90
RG6800014	XXL		39,90

Trade Pack: x1



- Material 100% nylon
- 10 pocket vest: 9 front and 1 back
- Dorsal part ventilated
- Excellent value for all fisheries with lures or lapping

## 10 POCKETS JACKET

Code	Size	Gencod	RRP (€)
AWQ680005	XS		24,90
AWQ680006	S		24,90
AWQ680000	M		24,90
AWQ680001	L		24,90
AWQ680002	XL		24,90
AWQ680003	XXL		24,90
AWQ680007	XXXL		24,90
RG6800006	XXXXL		24,90

Trade Pack: x1



100% cotton mesh panel at the back embroidered logo.

## RAGOT BASE BALL CAP

Code	Gencod	RRP (€)
RG6800005		9,50

Trade Pack: x1



# WADERS



The flagship RAGOT wader range, manufactured from high-quality 4 mm neoprene, that can withstand the cold. These waders also offer a more advanced manufacturing process with the different sections assembled by thermos-welding on all seams, making the waders more comfortable, durable and retaining water resistance over time. The inner neoprene is integral and goes to the end of each boot. Equipped with a ventral zip pocket to secure the keys or papers. Very comfortable adjustable shoulder straps and equipped with two rings to attach accessories. Supplied with a clip detachable belt. Finally, the additional protection placed on the knees extends the life of these waders, by strengthening the areas subjected to the most friction, without hindering freedom of movement. Delivered in carton box.

#### WADERS NEO 4MM

Code	Size	Color	Gencod	RRP (€)
RG1500026	38/39	Blue		139,90
RG1500027	40/41	Blue		139,90
RG1500028	42/43	Blue		139,90
RG1500029	44/45	Blue		139,90
RG1500030	46/47	Blue		139,90

Trade Pack: x1



A versatile range of waders manufactured from 3.5 mm neoprene. Can be used to fish from the beginning of the trout season, in cool waters. Equipped with very comfortable adjustable straps complete with two rings to attach accessories, a central pocket and rubber boots. Ideal for stalking trout in the river or when using a float tube when predator fishing. Delivered in carton box.

#### WADERS NEO STANDARD

Code	Size	Color	Gencod	RRP (€)
RG1500020	38/39	Green		119,90
RG1500035	40/41	Green		119,90
RG1500036	42/43	Green		119,90
RG1500037	44/45	Green		119,90
RG1500038	46/47	Green		119,90

Trade Pack: x1

# WADERS



Ideal all-season neoprene wader range. Manufactured 3.5 mm, equipped with very comfortable adjustable shoulder straps complete with two rings to attach accessories, a central pocket and PVC boots. Delivered in carton box.

## WADERS NEO PVC

Code	Size	Color	Gencod	RRP (€)
RG1500031	38/39	Grey		109,00
RG1500032	40/41	Grey		109,00
RG1500033	42/43	Grey		109,00
RG1500034	44/45	Grey		109,00
RG1500019	46/47	Grey		109,00

Trade Pack: x1



- Soft and comfortable PU material.
- PVC boots.
- Inside pocket.
- Wide straps adjustable by clips.
- Comes in a cardboard box.

## WADERS PU + PVC BOOTS

Code	Size	Color	Gencod	RRP (€)
AWQ150049	38	Green		59,90
AWQ150050	39	Green		59,90
AWQ150051	40	Green		59,90
AWQ150052	41	Green		59,90
AWQ150053	42	Green		59,90
AWQ150054	43	Green		59,90
AWQ150055	44	Green		59,90
AWQ150056	45	Green		59,90
AWQ150057	46	Green		59,90
AWQ150058	47	Green		59,90

Trade Pack: x1

# WADERS



- 1,2 mm natural rubber outer membrane
- 2,0 mm double interior Neoprene membrane
- Adjustable strap
- Sizes: 38 to 46
- Deliver in carton box

## NEOPRENE-LINED RUBBER HIP WADERS

Code	Size	Color	Gencod	RRP (€)
RG1500000	38	Green		84,90
RG1500001	39	Green		84,90
RG1500002	40	Green		84,90
RG1500003	41	Green		84,90
RG1500004	42	Green		84,90
RG1500005	43	Green		84,90
RG1500006	44	Green		84,90
RG1500007	45	Green		84,90
RG1500008	46	Green		84,90

Trade Pack: x1



- Very light hip waders and perfectly suited for itinerant fishing such as trout fishing in the river or carnivorous fishing. They are equipped with adjustable straps to cling to the belt.
- Flexible and comfortable PU material.
- PVC boots.
- Delivered in a nylon bag.

## HIP WADERS PU + PVC BOOTS

Code	Size	Color	Gencod	RRP (€)
RG1500009	38	Green		39,90
RG1500010	39	Green		39,90
RG1500011	40	Green		39,90
RG1500012	41	Green		39,90
RG1500013	42	Green		39,90
RG1500014	43	Green		39,90
RG1500015	44	Green		39,90
RG1500016	45	Green		39,90
RG1500017	46	Green		39,90
RG1500018	47	Green		39,90

Trade Pack: x1



Repair kit for thigh and waders. Waterproof, flexible and permanent repairs. Particularly suitable for quick field repairs.

Contains:

- Aquasure® 7g glue
- 2 black patches of repair + a transparent patch
- 1 brush
- 1 storage box

## REPAIR KIT AQUASURE®

Code	Gencod	RRP (€)
RG0130116		13,90

Trade Pack: x1



Glue for repair of waders in Gore Tex and others breathable products as well as waders, Neoprene and fishing shoes with felt soles. Capacity: 28g.

## AQUASURE®

Code	Gencod	RRP (€)
RG0130115		13,90

Trade Pack: x1



Universal glue, flexible after drying, for rubber boots or waders. 5g.

## GLUE STORMSURE x3

Code	Gencod	RRP (€)
015G 805145		14,90

Trade Pack: x1



# MYSTIC

MYSTIC pastes are easy to assemble and hold well to the hook, they do not flow and are indissoluble in water. Not perishable, cap well closed, they can be kept very long. Can be used alone, or mixed with other baits (excellent result on worms, maggots, etc ...). At the origin of the invention and 60 years later, the little red tube is still the favorite of fishermen. Of formidable efficiency alone or in variegated, it is of course the tube that must have in his basket seat. Yellow is ideal for imitating corn grain, wheat grain, cheese etc. With white, you will easily replace maggots, rice grain, bread crumbs etc. Finally, the green is it for a specific fishing: fishing Foam.



### MYSTIC KIT x12

Code	Color	Gencod	RRP (€)
990200221	Red		74,90

Trade Pack: x1



### SOFT MYSTIC KIT x12

Code	Color	Gencod	RRP (€)
AWQ750022	Red		80,20

Trade Pack: x1



### MYSTIC TUBE

Code	Color	Gencod	RRP (€)
990201221	Red		6,75
990301221	Yellow		6,75
AWQ750011	White		6,75
AWQ750012	Black		6,75

Trade Pack: x10



### FLUO MYSTIC TUBE

Code	Color	Gencod	RRP (€)
AWQ750001	Fluo Red		7,60

Trade Pack: x10



### MYSTIC TUBE X2

Code	Color	Gencod	RRP (€)
AWQ750002	Red / Yellow		12,50

Trade Pack: x10 (x2)



### SOFT MYSTIC TUBE X2

Code	Color	Gencod	RRP (€)
AWQ750003	Red / Yellow		14,10

Trade Pack: x10 (x2)



### SOFT MYSTIC TUBE

Code	Color	Gencod	RRP (€)
990601221	Red		7,50
AWQ750018	Yellow		7,50

Trade Pack: x10



# BAITS



Several colors and perfumes adapted to calm and common waters. For carp, tench, bream and all other white fish.

- Food quality.
- Exceptional pigmented colors.
- Holding the hook impeccable.
- Proteins and vitamins preserved.
- Sterilized packaging.
- Malignant lids to close the box during the fishing trip to preserve the seeds.

SWEETCORN				
Code	Weight	Color	Gencod	RRP (€)
106300161	340 g	White		5,40
101300161	340 g	Yellow		3,90

Trade Pack: x12

Excellent holding on the hook. Hyper attractive, enhanced in sugar.



WHEAT			
Code	Weight	Gencod	RRP (€)
437001161	212 ml		4,80

Trade Pack: x12



HEMP			
Code	Weight	Gencod	RRP (€)
436001161	212 ml		5,70

Trade Pack: x12



MICRO MAIZE			
Code	Weight	Gencod	RRP (€)
438001161	212 ml		4,80

Trade Pack: x12



VANILLA SWEETCORN			
Code	Weight	Gencod	RRP (€)
440001161	212 ml		5,50

Trade Pack: x12



STRAWBERRY SWEETCORN			
Code	Weight	Gencod	RRP (€)
439001161	212 ml		5,50

Trade Pack: x12



TUTTI-FRUITI SWEETCORN			
Code	Weight	Gencod	RRP (€)
582100161	212 ml		5,50

Trade Pack: x12





# SEA ACCESSORIES

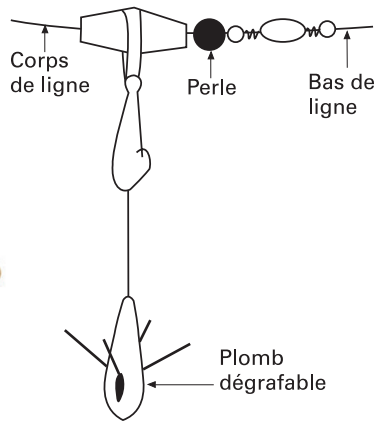

This slider allows the manufacture of sliding fixtures for fishing surfing but also the boat. 2 pieces.

### SLIDING SWIVELS & CLIP

Code	Color	Gencod	RRP (€)
RG0300225	Orange		2,40

Trade Pack: x6 (2 Pieces)

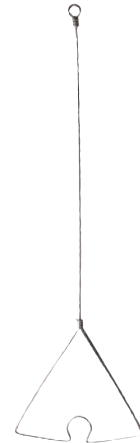

### STAINLESS STEEL TRIANGLE CLIPS

Code	Size	Gencod	RRP (€)
ME0010100	16 cm		2,00
ME0010200	18 cm		2,20
ME0010300	20 cm		2,45

Trade Pack: x10



Special surf rotary clip mounts on stainless steel tigne and rolling fixed between 2 beads.

### ROTARY CLIPOT SURF x 5

Code	Size	Gencod	RRP (€)
RG0300293	L		2,25

Trade Pack: x10 (5 per Bag)



Designed to bring lead back to recovery in congested areas. 2 rooms.

### FINS

Code	Size	Gencod	RRP (€)
RG0300220	L		1,50

Trade Pack: x6



Rolling + 2 phospho beads to make your bottom line rotary for your sea mounts. 2 sizes.

### BEADS + ROLLING

Code	Size	Gencod	RRP (€)
RG0300295	S		1,95
RG0300294	L		2,20

Trade Pack: x10

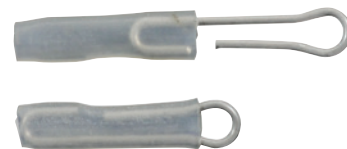

Stainless Steel Snap mainly for surf-casting and boat fishing and to be use at the end of the rig to quickly and easily attach the lead. SS 304.

### SS RAPID SNAP x 10

Code	Size	Gencod	RRP (€)
RG0300325	S		3,00
RG0300326	L		3,00

Trade Pack: x 10



- For finger protection against the Monofilament or braided line
- For surf-casting and all other type of fishing

### CASTING GLOVE

Code	Size	Gencod	RRP (€)
RG0300327	L		9,90
RG0300328	XL		9,90

Trade Pack: x 1

# SEA ACCESSORIES



## PHOSPHORESCENT SLIDING TUBE

Code	Size	Gencod	RRP (€)
MCO00010	4 cm		3,15
MCO00020	7 cm		3,15
MCO00030	10 cm		3,15

Trade Pack: x10 (3 per Bag)



## ANTI-TANGLE METAL

Code	Size	Gencod	RRP (€)
ATO010016	7 cm		4,05
ATO010017	10 cm		5,20

Trade Pack: x10 (3 per Bag)



OVAL FLOATING BEADS to be placed on the bottom of the line to reinforce the attraction thanks to the very visible fluorescent color. 3 colors.

## OVAL FLOATING BEADS FLUO

Code	Size	Color	Gencod	RRP (€)
RG0300304	15 x 7,5 mm	Fluo Orange		4,50
RG0300305	15 x 7,5 mm	Fluo Pink		4,50
RG0300306	15 x 7,5 mm	Fluo Yellow		4,50

Trade Pack: x10 (10 per packet)



Very visible luminescent tube to enhance the attraction of your rig length. 2 colors available.

## LUMINOUS TUBE SILICONE

Code	Color	Gencod	RRP (€)
RG0300311	Pink		1,15
RG0300312	Green		1,15

Trade Pack: x10 (1 per Bag)



Transparent beads with double drilling for the realization of very discreet bottom lines. 4 sizes.

## OVAL CROSS BEAD

Code	Size	Gencod	RRP (€)
RG0300307	S : 2,3 x 5 mm		1,15
RG0300308	M : 3 x 5 mm		1,15
RG0300309	L : 4 x 6 mm		1,15
RG0300310	XL : 5 x 7 mm		1,15

Trade Pack: x10 (20 per Bag)

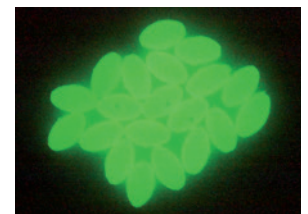

- Reinforce the attractiveness of the bait by placing the pearls near the hooks
- Also to make rigs or protect knots

## SOFT LUMINOUS OVAL BEADS

Code	Ø	Gencod	RRP (€)
RG0321008	3 mm		1,30
RG0321009	4 mm		1,30
RG0321010	5 mm		1,30
RG0321011	6 mm		1,40
RG0321012	7 mm		1,40

Trade Pack: x6 (20 per Bag)



# SEA ACCESSORIES

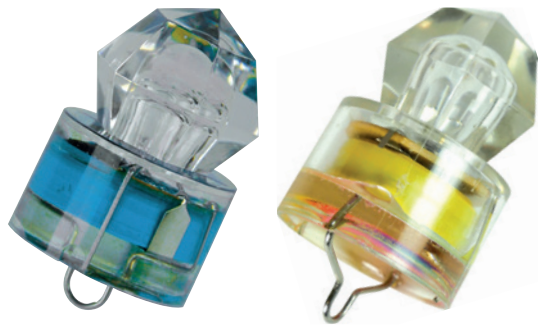

- Use when fishing at great depths to attract fish.
- Blinks when immersed in water and turns off when leaving.
- Battery integrated in the diode

AUTOMATIC DIODE			
Code	Color	Gencod	RRP (€)
ATO320012	Green		6,15
ATO320013	Red		6,15
ATO320000	Blue		6,15
ATO320014	White		6,15
RG0121007	Multicolor (Blue/red/green)		6,15

Trade Pack: x10 (1 per Blister)



DEEP SEA DIODE			
Code	Color	Gencod	RRP (€)
ATO320015	White		7,30

Trade Pack: x10 (1 per Blister)

# SQUID JIGS



Wanted: Trout, Perch, Pikeperch, Pike, Shad, Mackerel, Bar, Wolf, Orphie, Trevally, Carp, Red

SQUID JIG				
Code	Weight	Color	Gencod	RRP (€)
RG6683361	60 g	White		7,40

Trade Pack: x5 (1 per Blister)

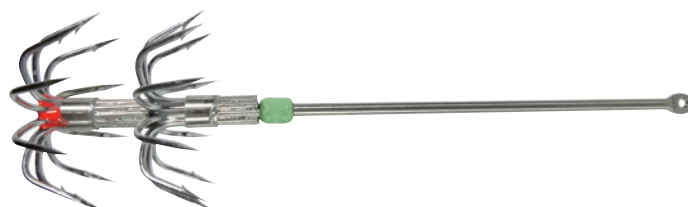

- Length 20 cm
- Stainless Steel tube
- Stainless Steel hooks with Barb
- 10 hooks per basket

SQUID JIG NEEDLE			
Code	Size	Gencod	RRP (€)
RG6621002	20 cm		8,90

Trade Pack: x5 (1 per Blister)

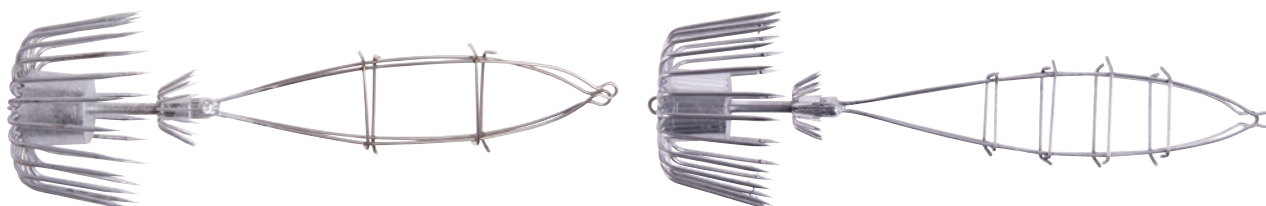

SQUID CAGE			
Code	Specifications	Gencod	RRP (€)
ATO660001	88 g		10,30
ATO660003	150 g		13,95

Trade Pack: x10 (1 per Blister)

# ACCESSORIES

- USB rechargeable
- Adjustable elastic head strap
- Light weight (60g)
- Motion detection sensor (on/off by movement gesture) motion gesture)
- Manual on/off also possible
- Internal 1000 mAh battery
- 5W LED
- Three light intensities



HEADLAMP SENSOR			
Code	Specifications	Gencod	RRP (€)
RG0300298	150 Lumens		29,90

Trade Pack: x1 (Blister)

- OB led & 4 UV leds
- Rechargeable by USB (cable included)
- 100 lumens and 3 intensities
- UV led wavelength: 390NM
- 80° rotating head
- Material: ABS and elastic
- Built-in rechargeable lithium battery 500MAH
- Charging indicator
- Clip adaptable to visor



HEADLAMP RECHARGEABLE			
Code	Specifications	Gencod	RRP (€)
RG0300299	100 Lumens		19,90

Trade Pack: x1 (Blister)



Ultra Bright LEDs, extended life (about 100000h). Adjustable strap and multiposition case.  
 Battery life in continuous use: 1 LED: 120 h, 3 LEDs: 60 h, 7 LEDs: 30 h, 7 LEDs FLASH: 50 h  
 Works with 3 1.5 V "AAA" batteries not included.

HEADLAMP			
Code	Specifications	Gencod	RRP (€)
ATO380000	7 LEDs - 50 Lumens		4,90

Trade Pack: x1 (Blister)



Ultra Bright LEDs, extended life (about 100000h). Adjustable strap and multiposition case.  
 Battery life in continuous use: 4 LEDs: 120 h, 8 LEDs: 60 h, 14 LEDs: 30 h, 14 LEDs FLASH: 50 h  
 Works with 3 1.5 V "AAA" batteries not included.

HEADLAMP			
Code	Specifications	Gencod	RRP (€)
ATO380001	14 LEDs - 100 Lumens		6,90

Trade Pack: x1 (Blister)



Fiber support with foam inner, for comfort during the fight. Adjustable gimbal. Nylon strap with safety clip closure.

FIGHTING BELT		
Code	Gencod	RRP (€)
RG0300302		17,25

Trade Pack: x1



- Telescopic bar for measuring fish.
- Expandable in 4 parts from 15 to 51 cm.
- Small footprint when folded.

METRE TRAY		
Code	Gencod	RRP (€)
AWQ010125		10,40

Trade Pack: x5

# ACCESSORIES



Scissors specially designed for the removal of the tail of fish. Ergonomic handles.

Order of 17 May 2011

This Order applies to recreational marine fishing exercised in all its forms on foot, shore, underwater or on board.

It applies in waters under sovereignty or French jurisdiction. Specimens of the species fished which are annexed to this Order must be marked. This marking consists of the ablation of the lower part of the caudal fin.

Concerned species: Bar, Bonito, Cod, Corb, Denti, Bream, Swordfish, Lobster, Lobster, Place, Lean, Mackerel, Mackerel, Marlin, Pager, Scorpionfish, Sar, Sole, Thazard, Tuna, Sailboat of the Atlantic.

Decree available on: <http://www.legifrance.gouv.fr>

## TAIL SCISSORS

Code	Size	Gencod	RRP (€)
RG0300329	20 cm (blade 6,8 cm)		6,90

Trade Pack: x3 (1 per Blister)



- Floating knife with stainless steel blade.
- Ergonomic handle.
- Supplied in a hard protective case for extra protection.
- Red cap to easily locate the knife in the event of a fall in the water.
- Sharp blade on one side and scaling function on the other.

## FLOATING KNIFE

Code	Size	Gencod	RRP (€)
ATO010034	Handle 14,5 cm / Blade 13,5 cm		8,45

Trade Pack: x3 (1 per Blister)



To easily scale the fish.

## STAINLESS STEEL DE-SCALER

Code	Gencod	RRP (€)
ATO010050		3,35

Trade Pack: x5 (1 per Bag)

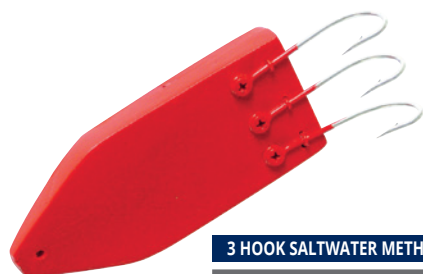

## 3 HOOK SALTWATER METHOD - RED

Code	Weight	Gencod	RRP (€)
AA00208B0	140 g		14,95

Trade Pack: x5 (1 per Blister)



The Aquadive® used for light trolling, are attractive by their low frequency vibration and by the animation that they give to the lures. Plunge easily and go back to the touch.

## AQUADIVE®

Code	Size	Gencod	RRP (€)
RG5831018	18 cm		8,80

Trade Pack: x6 (1 per Blister)

- Elastic 0,10 mm widely used in competition for all fragile and delicate baits of use, very practical for the small pieces of shrimp, mold and fragile baits.

- 0,20 mm elastic is widely used for larger baits such as squid, sardines, knives... a little stronger than the size N°1 but remains very discreet for the fish.

- Supplied in a protective tube.



## BAIT ELASTIC

Code	Ø	Size	Gencod	RRP (€)
ATO010032	0,10 mm	200 m		3,99
ATO010033	0,20 mm	200 m		3,99

Trade Pack: x5

This elastic thread has a great resistance, it can be used to hold bait in place on the hook, avoiding detachment from the hook when casting & hitting the water. It also prevents small fish from taking the bait off the hook.



## ELASTIC LINE SPOOL

Code	Size	Gencod	RRP (€)
13BFHEL	200 m		13,45

Trade Pack: x1 (Box of 5)



# WINDERS



## CORK WINDERS

Code	Gencod	RRP (€)
154700221		8,80

Trade Pack: x5 (1 per Bag)



## EVA WINDER 65MM x 10

Code	Gencod	RRP (€)
RG0300314		8,00

Trade Pack: x1 (10 per pack)

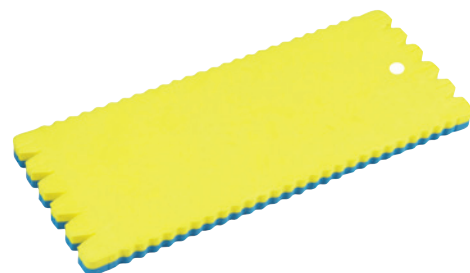

## COMPACT FOAM RIG WINDERS

Code	Size	Gencod	RRP (€)
ATO530025	15,4 x 5,5 cm		9,70

Trade Pack: x1 (10 per pack)

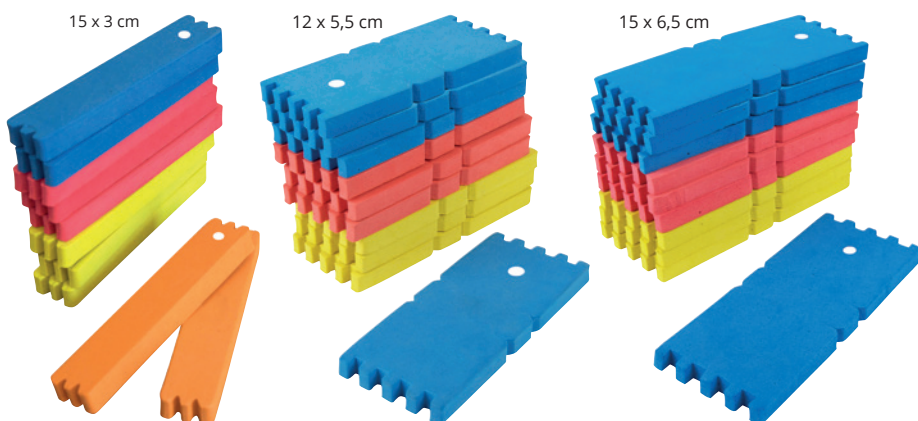

## RECTANGLE WINDER

Code	Size	Color	Gencod	RRP (€)
ATO530019	15 x 3 cm	2 orange, 3 red, 3 yellow, 2 blue		4,75
AA0020100	12 x 5,5 cm	4 blue, 3 red, 3 yellow		6,60
AA0021000	15 x 6,5 cm	4 blue, 3 red, 3 yellow		9,25

Trade Pack: x1 (10 per pack)



Box consisting of 24 round burrs made of dense EVA foam and 65 mm diameter. To store and have at hand all your ready-to-use montages.

## BOX OF 24 ROUND RIG WINDERS D65

Code	Specifications	Gencod	RRP (€)
ATO140000	24 winders		35,35
RG0300315	10 winders		11,45

Trade Pack: x1

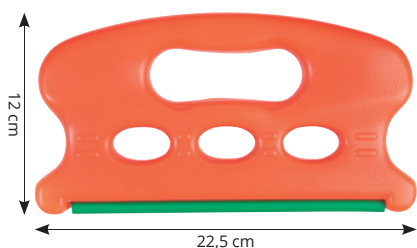

## FLOUROSCENT RIG WINDER

Code	Gencod	RRP (€)
RG0330600		7,65

Trade Pack: x1 (1 per Bag)



Folder with chamfered edges to prevent breakage of the nylon.

## CORK RIG WINDER

Code	Size	N°	Gencod	RRP (€)
RG5530050	150 x 55 x 10 mm	0		4,65
RG5530100	150 x 100 x 13 mm	1		5,50
RG5530200	200 x 120 x 13 mm	2		7,40
RG5530300	250 x 180 x 20 mm	3		14,65

Trade Pack: x1



Cork rig boards with 8 grooves, ideal for storing pre-tied rigs. Natural cork of high durability and resistance. 7,8 x 7,2 x 1,5 cm.

## CORK RIG BOARD

Code	Gencod	RRP (€)
33BFP8R		4,25

Trade Pack: x2



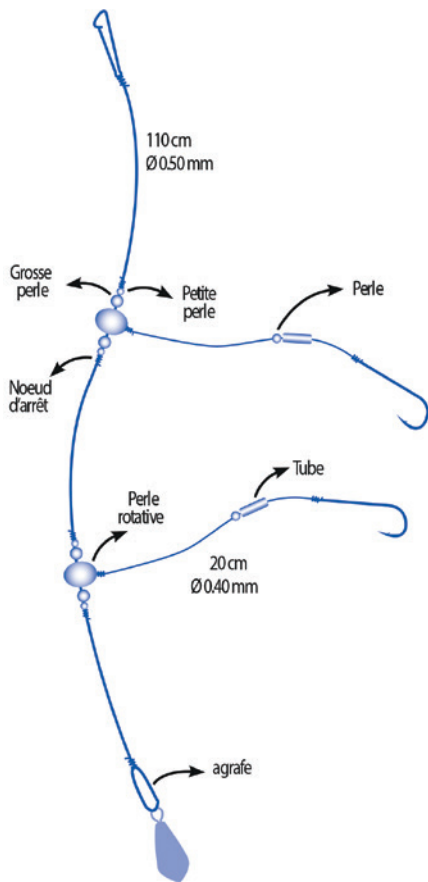

Effective assembly for beach, port or estuary fishing.

### 2 HOOK PATERNOSTER SPECIAL BASS

Code	Size	Ø	N°H	Gencod	RRP (€)
RG1200123	110 cm	0,40 mm	2		5,05

Trade Pack: x6

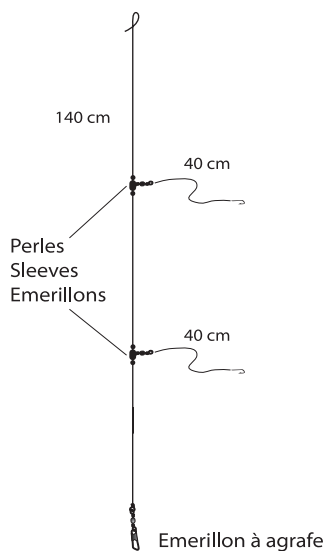

### ROTATING 2 HOOK PATERNOSTER «DISCRETION»

Code	Size	Ø	N°H	Gencod	RRP (€)
RG1200509	140 cm	0,45 mm	1		3,15
RG1200510	140 cm	0,45 mm	2		3,15
RG1200511	140 cm	0,40 mm	4		3,15

Trade Pack: x12

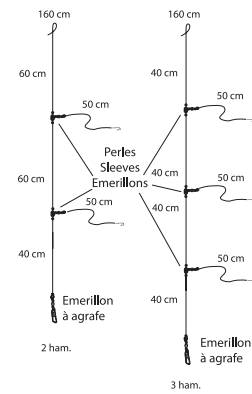

### 2 HOOK PATERNOSTER FLAT FISH

Code	Size	Ø	N°H	Gencod	RRP (€)
RG1200430	160 cm	0,50 mm	1		4,25
RG1200431	160 cm	0,50 mm	2		4,25
RG1200432	160 cm	0,45 mm	4		4,25

Trade Pack: x12

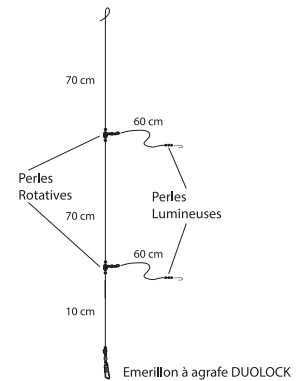

### ROTATING 2 HOOK PATERNOSTER WITH BEADS

Code	Size	Ø	N°H	Gencod	RRP (€)
RG1200524	150 cm	0,45 mm	1		3,15
RG1200525	150 cm	0,45 mm	2		3,15

Trade Pack: x12

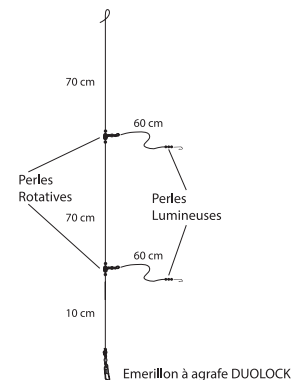

### ROTATING 2 HOOK PATERNOSTER WITH BEADS

Code	Size	Ø	N°H	Gencod	RRP (€)
RG1200530	150 cm	0,45 mm	2		2,85
RG1200531	150 cm	0,45 mm	4		2,85
RG1200532	150 cm	0,40 mm	6		2,85

Trade Pack: x12

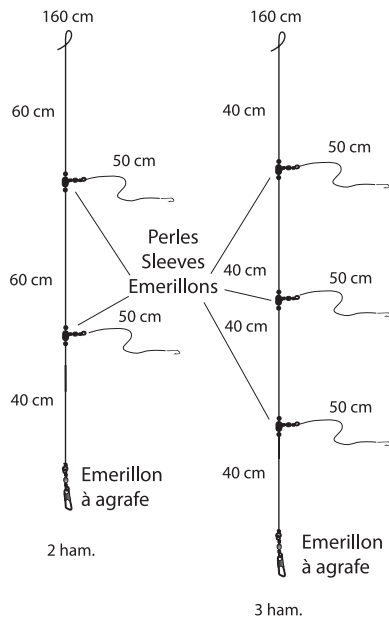

### 3 HOOK PATERNOSTER FLAT FISH

Code	Size	Ø	N°H	Gencod	RRP (€)
RG1215021	160 cm	0,50 mm	1/0		5,05
RG1215022	160 cm	0,50 mm	1		5,05
RG1215023	160 cm	0,50 mm	2		5,05
RG1215024	160 cm	0,45 mm	4		5,05

Trade Pack: x12

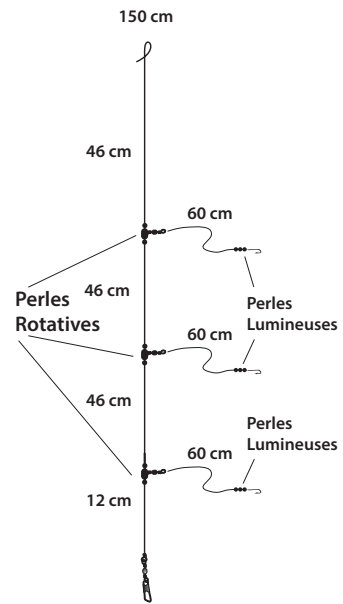

### ROTATING 3 HOOK PATERNOSTER WITH BEADS

Code	Size	Ø	N°H	Gencod	RRP (€)
RG1215063	150 cm	0,45 mm	2		3,65
RG1215064	150 cm	0,40 mm	4		3,65
RG1215065	150 cm	0,40 mm	6		3,65

Trade Pack: x12

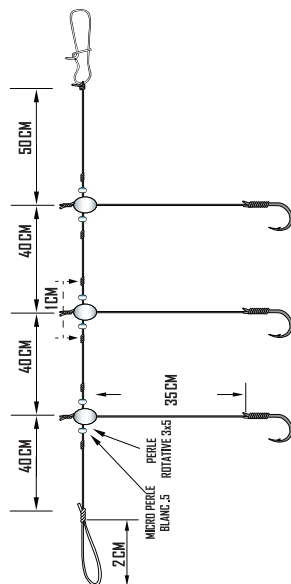

Useful rig in competition. Very discreet. Fluorocarbon line.

### 3 HOOK COMPETITION BOAT RIG

Code	Size	Ø	N°H	Gencod	RRP (€)
RG1221007	170 cm	40/35	1/0		6,05
RG1221008	170 cm	40/35	1		6,05
RG1218001	170 cm	35/30	2		6,05
RG1218002	170 cm	35/28	4		6,05

Trade Pack: x10

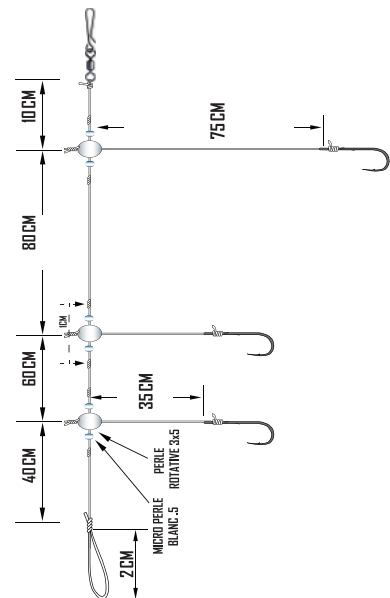

Rig that allows to target fish different with the same setup: a train for difficult fish and two small higher stacks. Fluorocarbon line.

### 3 HOOK MIXED SURF RIG

Code	Size	Ø	N°H	Gencod	RRP (€)
RG1221009	190 cm	50/35	1/0		7,90
RG1221010	190 cm	50/30	1		7,90
RG1218008	190 cm	50/30	2		7,25
RG1218009	190 cm	50/28	4		7,25

Trade Pack: x10

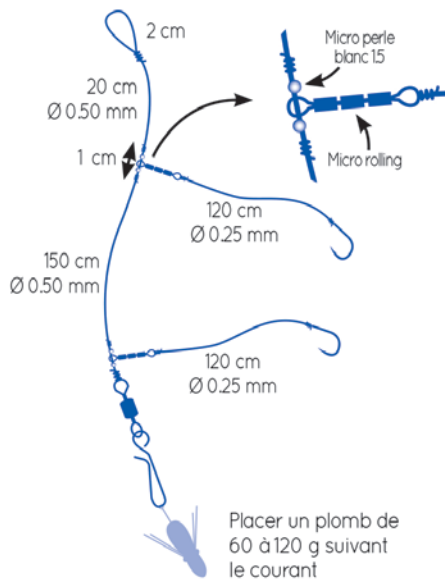

Discreet editing and adapted to calm conditions where the sea does not move and where fish are difficult. Discreet and very versatile editing that will interest all species of fish that can be found in surf casting as sea bream, sole, mullet, sea bass, sea bream... A montage to use in calm and rough sea with worms "half-hard, hard, white nereid, worms of water..."

### 2 HOOK SURF RIG

Code	Size	Ø	N°H	Gencod	RRP (€)
RG1218014	170 cm	50/25	4		7,25

Trade Pack: x10

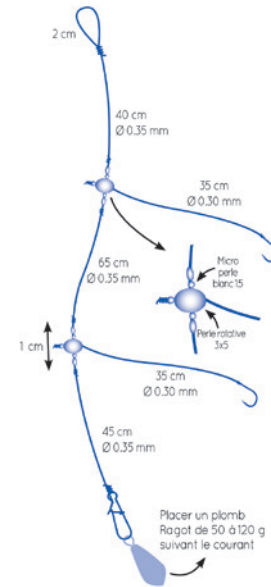

Simple assembly and effective for all the fisheries to support. Versatile editing for the majority of fish species. Fluorocarbon line.

### 2 HOOK BOAT RIG

Code	Size	Ø	N°H	Gencod	RRP (€)
RG1221003	150 cm	40/35	1/0		5,50
RG1221004	150 cm	40/35	1		5,50
RG1218016	150 cm	35/30	2		4,95
RG1218017	150 cm	35/30	4		4,95

Trade Pack: x10

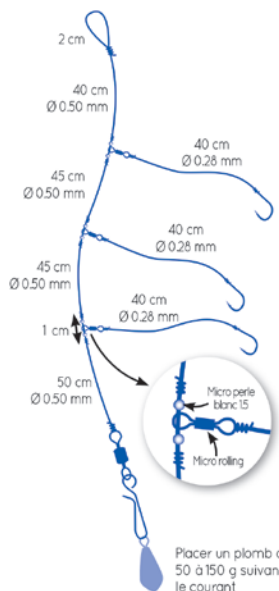

Simple and effective assembly for all edge fishing of sea. Versatile for the majority of fish species. Fluorocarbon line.

### 3 HOOK SURF RIG

Code	Size	Ø	N°H	Gencod	RRP (€)
RG1221005	180 cm	50/35	1/0		7,90
RG1221006	180 cm	50/30	1		7,90
RG1218019	180 cm	50/28	2		7,25
RG1218020	180 cm	50/28	4		7,25

Trade Pack: x10

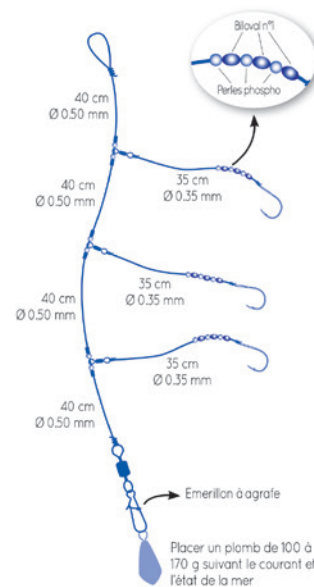

A very versatile rig that caters for many species of fish. The presence of beads near the hook increases attractiveness of the bait. Nylon line.

### 3 HOOK SURF RIG FLAT FISH / BASS

Code	Size	Ø	N°H	Gencod	RRP (€)
RG1221011	160 cm	50/35	1/0		5,15
RG1221012	160 cm	50/35	1		4,95
RG1221013	160 cm	50/35	2		4,95
RG1221014	160 cm	45/30	4		4,95

Trade Pack: x10

# SEA RIGS



Tackle for bottom fishing with high quality fluorocarbon line and three carbon hooks.

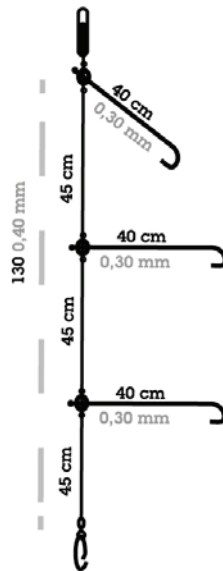

### FLUORO BOTTOM RIG

Code	Size	Ø	N°H	Gencod	RRP (€)
RG1221047	185 cm	40/30	1/0		3,85
RG1221048	185 cm	40/30	1		3,85
RG1221049	185 cm	40/30	2		3,85
RG1221050	185 cm	40/30	4		3,85

Trade Pack: x10

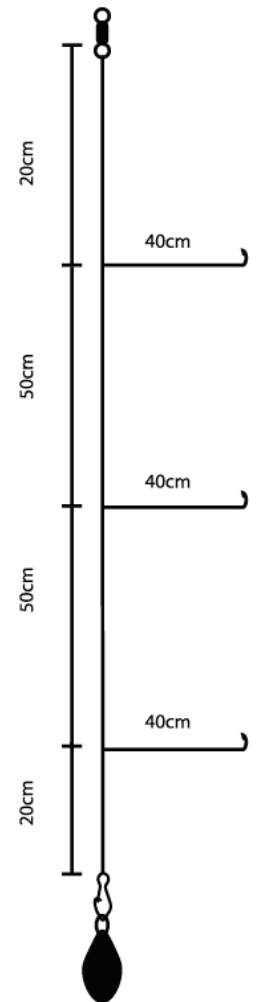

Tackle mounted with Fluorocarbon and carbon hooks provided with a great sharpening, the multiperforated beads allow a perfect twist that prevents entanglements.

### ROTATY RIG

Code	Size	Ø	N°H	Gencod	RRP (€)
RG1221044	140 cm	40/33	1		2,90
RG1221045	140 cm	40/33	2		2,90
RG1221046	140 cm	40/33	4		2,90

Trade Pack: x10

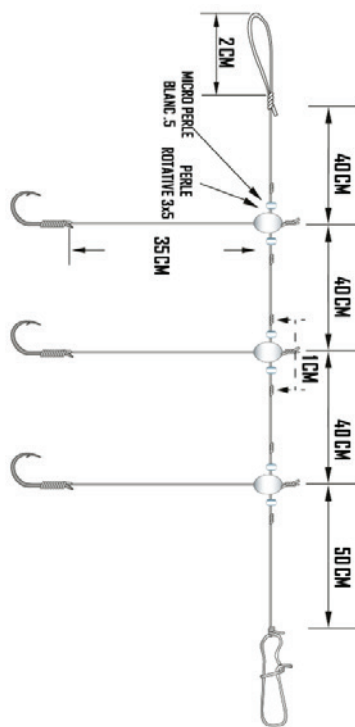

Tackle rigged with three hooks and strong nylon, ideal for boat fishing. Each bag contains three rigs.

### BOAT RIG

Code	Size	Ø	N°H	Gencod	RRP (€)
RG1221041	120 cm	35/30	4		2,25
RG1221042	120 cm	35/30	6		2,25
RG1221043	120 cm	35/30	8		2,25

Trade Pack: x10



# SEA RIGS

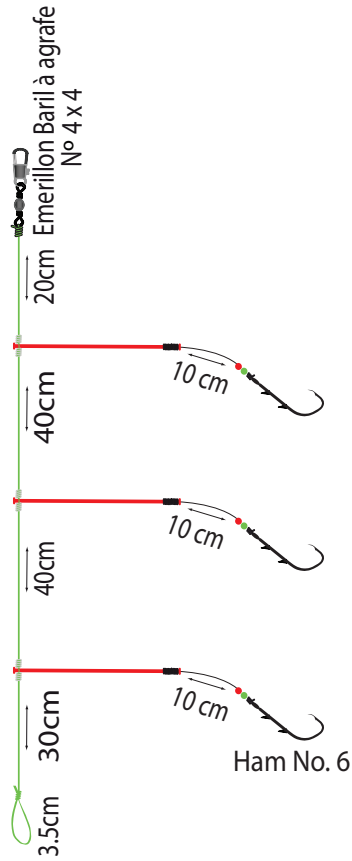

## 3 HOOKS CLIP HAIR BOOM WITH BEADS

Code	N°H	Specifications	Gencod	RRP (€)
MCLI01260	2	3 Hooks		3,95
MCLI01270	4	3 Hooks		3,95
MCLI01280	6	3 Hooks		3,95

Trade Pack: x10

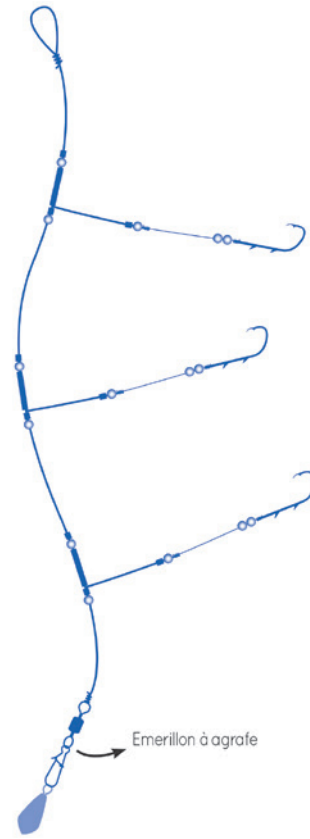

## SPIRAL STEEL CLIPS

Code	Size	Ø	N°H	Specifications	Gencod	RRP (€)
MCLI01200	1,10 m	0,50 mm	1/0	3 Hooks		3,70
MCLI01170	1,10 m	0,45 mm	2	3 Hooks		3,70
MCLI01180	1,10 m	0,40 mm	4	3 Hooks		3,70
MCLI01190	1,10 m	0,35 mm	6	3 Hooks		3,70

Trade Pack: x10

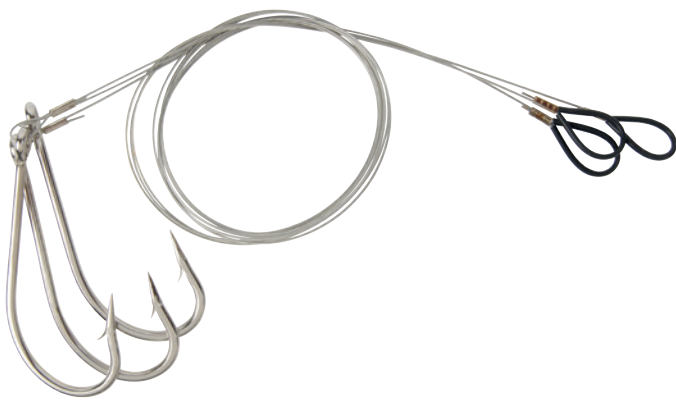

## SINGLE CONGA HOOK TRACE

Code	Strength	N°H	Gencod	RRP (€)
MBDLC0600	40 kg	6/0		4,85
MBDLC0800	60 kg	8/0		5,20

Trade Pack: x10

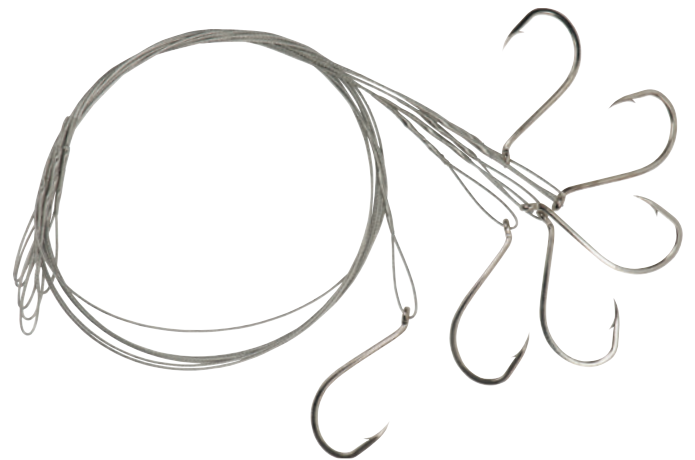

## SINGLE HOOK TRACE

Code	Strength	N°H	Gencod	RRP (€)
AM2011800	18 kg	1/0		4,50
AM2042300	23 kg	4/0		4,50
AM2062700	27 kg	6/0		4,50

Trade Pack: x10

# SEA RIGS

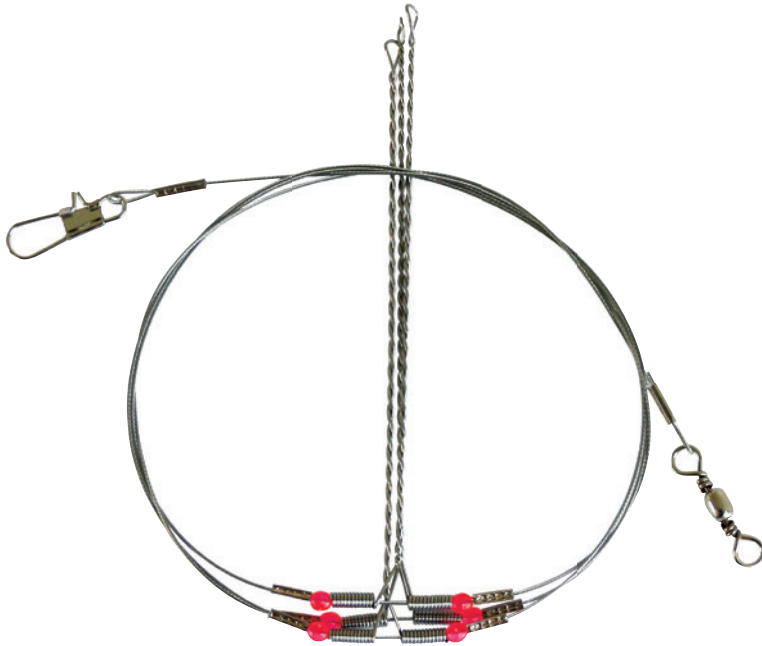

## STEEL CLIPS PATERNOSTER

Code	Size	Ø	Strength	Specifications	Gencod	RRP (€)
ME0007400	90 cm	0,50 mm	30 Lbs	3 Clips 7 cm		1,95
ME0007300	1 m	0,55 mm	40 Lbs	2 Clips 12 cm		1,95
ME0007500	1 m	0,55 mm	40 Lbs	3 Clips 12 cm		2,40
ME0007600	1,50 m	0,65 mm	60 Lbs	3 Clips 15 cm		2,40
ME0007700	1,50 m	0,65 mm	60 Lbs	4 Clips 15 cm		2,75

Trade Pack: x10

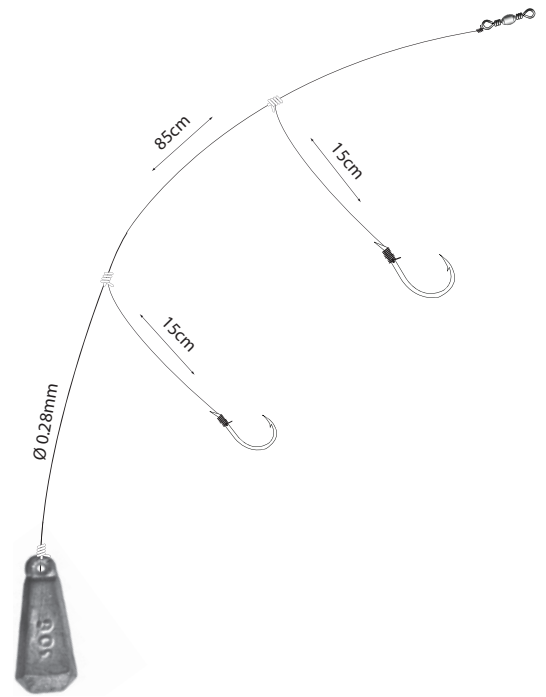

## 2 HOOK END RIG WITH LEAD

Code	Weight	N°H	Gencod	RRP (€)
ME0029000	30 g	10 & 12		5,20
ME0029600	30 g	8 & 10		5,20
ME0029500	40 g	6 & 8		5,20
ME0029400	50 g	4 & 6		5,20

Trade Pack: x10 (2 per Bag)

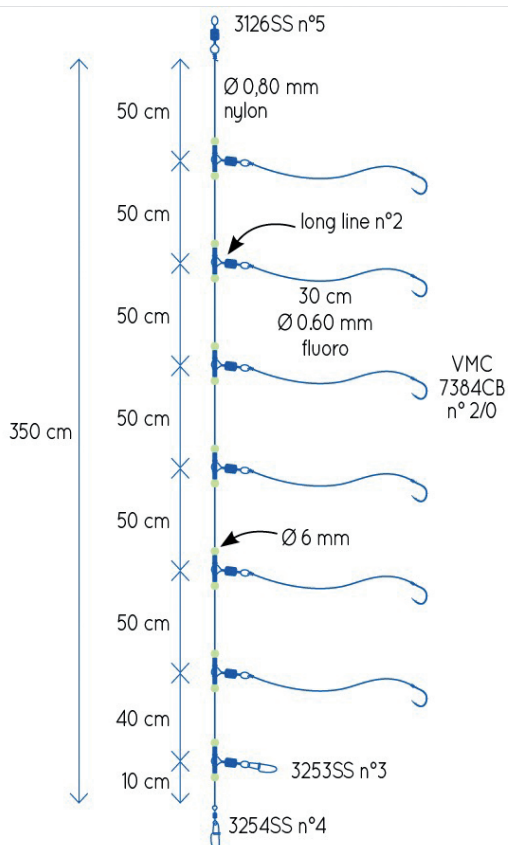

- High-quality deep sea rig mounted on VMC rig mounted on VMC hooks 7384 CB 2/0.
- Auto catch for difficult fishing of pink dorado, rockfish and other species.
- 3,5m Main line in nylon 80/100
- 6 x 30 cm branch lines in Fluorocarbon 60/100 mounted on long line swivels and fixed between 2 glued luminous beads.
- A Stainless Steel VMC swivel 3126 connects the rig to the main line.
- A Stainless Steel VMC 3253 snap is placed on the bottom of the rig to attach an automatic diode on it.
- Rig ending with a Stainless Steel VMC 3254 snap to fix the lead on it.

## DEEP SEA RIG 1

Code	Size	N°H	Gencod	RRP (€)
RG1221015	N°1	2/0		23,10

Trade Pack: x5

# MITRAILLETES

Since its creation in 1954 by André Ragot, the Mitraillette® Original has become a flagship product of the brand. A formidable efficiency and a must in his fishing box!



MITRAILLETTE® ORIGINAL WHITE BRIGHT							
Model	Code	Gencod	RRP (€)	Model	Code	Gencod	RRP (€)
3 H 1/0 0,40 mm	RG4410310		3,00	5 H 2 0,40 mm	RG4410502		4,25
3 H 2/0 0,50 mm	RG4410320		3,00	5 H 4 0,35 mm	RG4410504		4,25
3 H 3/0 0,60 mm	RG4410330		3,00	5 H 6 0,30 mm	RG4410506		4,25
4 H 2 0,35 mm	RG4410402		3,25	5 H 1/0 0,50 mm	RG4410510		4,25
4 H 1/0 0,40 mm	RG4421013		3,25	5 H 2/0 0,60 mm	RG4410520		4,25
4 H 2/0 0,50 mm	RG4410420		3,25	7 H 3/0 0,70 mm	RG4410730		5,75

Trade Pack: x12



MITRAILLETTE® ORIGINAL RED BRIGHT & YELLOW			
Model	Code	Gencod	RRP (€)
3 H 2/0 0,50 mm	RG4411320		3,25
4 H 2/0 0,50 mm	RG4411420		3,25
5 H 1/0 0,50 mm	RG4418024		4,25
5 H 2/0 0,60 mm	RG4411520		4,25
7 H 3/0 0,70 mm	RG4411730		5,75

Trade Pack: x12

MITRAILLETTE® ORIGINAL GREEN BRIGHT			
Model	Code	Gencod	RRP (€)
5 H 2/0 0,60 mm	RG4410500		4,25

Trade Pack: x12

MITRAILLETTE® ORIGINAL WHITE & BLUE BRIGHT			
Model	Code	Gencod	RRP (€)
5 H 1/0 0,50 mm	RG4418019		4,25
5 H 2/0 0,60 mm	RG4412520		4,25

Trade Pack: x12



MITRAILLETTE® ORIGINAL							
Model	Code	Gencod	RRP (€)	Code	Gencod	RRP (€)	
White Bright				Red Bright & Yellow			
5H 2/0 - 0,60 mm	RG4412000		11,00	RG4412002		11,00	

Trade Pack: x4

# MITRAILLETES



White Bright



Red Bright & Yellow



Red Bright



Multi Bright

Our best Monofilament mounted with hooks 100% stainless steel that do not rust. For the most demanding fishermen.

## MITRAILLETTE® ORIGINAL STAINLESS STEEL

Model	Code	Gencod	RRP (€)	Code	Gencod	RRP (€)
			White Bright		Multi Bright	
5 H 2/0 – 0,60 mm	RG4400200		4,60	RG4400203		4,60
5 H 4/0 – 0,70 mm	RG4400190		5,75	-	-	-
			Red Bright		Red Bright & Yellow	
5 H 2/0 – 0,60 mm	RG4400201		4,60	RG4400202		4,60
5 H 4/0 – 0,70 mm	-	-	-	RG4400192		5,75

Trade Pack: x12



Red Bright & Yellow



White Bright

Reinforced mounting for professional fishing. This model is designed with more space between the 5th and the 6th branch. The fisherman can seize the Mitraillette® with both hands with great ease and pick up the fish with a single gesture. 10 ham. 3/0- 0,80 mm.

## MITRAILLETTE® ORIGINAL SPECIAL PRO

Model	Code	Gencod	RRP (€)	Code	Gencod	RRP (€)
			White Bright		Red Bright & Yellow	
10 H 3/0 0,80 mm	RG4411830		7,55	RG4410830		7,55

Trade Pack: x12



Mitraillette® Very Versatile.

## MITRASSORTI

Model	Code	Gencod	RRP (€)
5 H 1/0 0,50 mm	RG4400330		4,95

Trade Pack: x12



This Mitraillette® has 4 Octopus with attractive colours.

## MITRAILLETTE® OCTOPUS

Model	Code	Gencod	RRP (€)
4 H 2/0 0,50 mm	RG4470206		5,95

Trade Pack: x12



Imitation squid. With 6 hooks N°4.

## BLUE RUNNER

Model	Code	Gencod	RRP (€)
6 H 4 0,45 mm	RG4415200		7,55

Trade Pack: x12



Imitation squid. With 4 hooks N°4.

## SQUID SKIRT

Model	Code	Gencod	RRP (€)
4 H 4 0,45 mm	RG4415220		4,95

Trade Pack: x12



# MITRAILLETES

Made from iridescent filaments and florets that mimic mini crustaceans, embellished with phosphorescent pearls, the Mitraflash® have an exceptional rendering. The models 5 H 1/0 and 5 H 2 also exist in packs of 3 Mitraflash®.



The best Mitraillette® of the world in Stainless Steel version!

### MITRAFLASH® AURORA STAINLESS STEEL

Model	Code	Gencod	RRP (€)
5 H 6 0,30 mm	RG4400204		4,25
5 H 4 0,35 mm	RG4400205		4,25
5 H 2 0,40 mm	RG4400206		4,25
5 H 1/0 0,50 mm	RG4400207		4,60
5 H 2/0 0,60 mm	RG4400208		4,60

Trade Pack: x12



### MITRAFLASH®

Model	Code	Gencod	RRP (€)
5 H 2 0,40 mm	RG4440502		3,90
5 H 4 0,35 mm	RG4440504		3,90
5 H 6 0,30 mm	RG4440506		3,90
5 H 8 0,30 mm	RG4440508		3,90
5 H 1/0 0,50 mm	RG4440510		3,90
5 H 2/0 0,55 mm	RG4440520		3,90
5 H 3/0 0,60 mm	RG4440530		3,90

Trade Pack: x12



### MITRAFLASH®

Model	Code	Gencod	RRP (€)
5 H 1/0 - 0,50 mm	RG4442000		10,50

Trade Pack: x12



- Made from real fish skin
- Target Fish: Seabass, Cod, Mackerel

### MITRASKIN

Model	Code	Gencod	RRP (€)
5 H 2/0 0,60 mm	RG4421003		7,15
5 H 1/0 0,50 mm	RG4421004		7,15
5 H 2 0,40 mm	RG4421005		7,15
5 H 4 0,35 mm	RG4421006		7,15
5 H 6 0,30 mm	RG4421007		7,15

Trade Pack: x12



In true mackerel skin, this Mitraillette® is of formidable efficiency. Sizes 1/0 to 6 are recommended for mackerel, bass, mackerel and mackerel; size 8 is perfect for sand eels, sardines, smelts... Bottom line of 120 cm

### RAINBOW SKIN 120 cm

Model	Code	Gencod	RRP (€)
4 H 1/0 - 0,50 mm	RG4415001		6,30
4 H 2 - 0,50 mm	RG4415002		6,30
6 H 4 - 0,40 mm	RG4415003		6,30
6 H 6 - 0,40 mm	RG4415004		6,30

Trade Pack: x12



Natural



Red

Made from real fish skin. 100% Fluorocarbon assembly. Formidable efficiency. Target fish : horse mackerel, sand eels, smelts

### RAINBOW SKIN FLUORO

Model	Code	Gencod	RRP (€)	Code	Gencod	RRP (€)
		Natural		Red		
6 H 6 - 0,24 mm	RG4421025		5,90	RG4421028		5,90
6 H 8 - 0,22 mm	RG4421026		5,90	RG4421029		5,90

Trade Pack: x12

# MITRAILLETES



Fluo Green



Fluo Yellow



Fluo Red

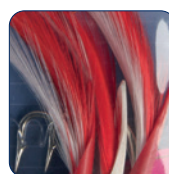

Red & White

3 hooks

MITRALIEU						
Model	Code	Gencod	RRP (€)	Code	Gencod	RRP (€)
			Fluo Yellow		Red & White	
3 H 3/0 - 0,60 mm	RG4400321		4,25	RG4400323		4,25
			Fluo Red		Fluo Green	
3 H 3/0 - 0,60 mm	RG4400322		4,25	RG4400320		4,25

Trade Pack: x12



Fluo Green



Fluo Yellow

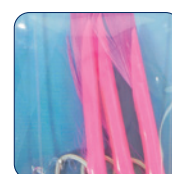

Fluo Pink



Fluo Orange



Red

XL version of MITRALIEU. Mounted in 5/0 in 80/100. Very effective on Cod. 5 very visible colours

MITRALIEU XL										
Model	Code	Gencod	RRP (€)	Code	Gencod	RRP (€)	Code	Gencod	RRP (€)	
			Fluo Yellow		Fluo Orange			Fluo Pink		
3 H 5/0 0,80 mm	RG4421015		4,95	RG4421017		4,95	RG4421016		4,95	
			Red		Fluo Green					
3 H 5/0 0,80 mm	RG4421030		4,95	RG4421014		4,95				

Trade Pack: x12



- Mini phosphorescent head tubes finished with a skirt
- Silver synthetic fibers
- Target Fish: Seabass, Mackerel, Garfish, Horse mackerel.

OCTOFINE			
Model	Code	Gencod	RRP (€)
5 H 2 0,40 mm	RG4421000		4,60
5 H 4 0,35 mm	RG4421001		4,60

Trade Pack: x12



# MITRAILLETES



AYU

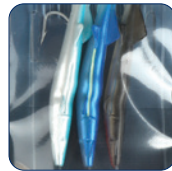

Multi



Pearl



Assort.Pearl



Glow

In fishing action, this montage imitates a school of small sand eels chased by predators. Very attractive for the bass, the plaice and the mackerel.



## MITRAILLETTE® RAGLOU®

Model	Code	Gencod	RRP (€)	Code	Gencod	RRP (€)	Code	Gencod	RRP (€)
AYU			Multi			Pearl			
3 Raglou 105 - 0,70 mm	RG4490606		11,00	RG4490608		11,00	RG4490601		11,00
4 Raglou 85 - 0,50 mm	RG4490506		11,00	RG4490508		11,00	RG4490501		11,00
Assort.Pearl			Glow						
4 Raglou 85 - 0,50 mm	RG4490507		11,00	RG4490503		11,00			

Trade Pack: x12



Silver



White



Blue

Incredibly effective!

## MITRARGENT

Model	Code	Gencod	RRP (€)
Silver			
5 H 1/0 - 0,50 mm	RG4400303		3,90
5 H 2 - 0,45 mm	RG4400302		3,90
5 H 2/0 - 0,60 mm	RG4400304		3,90
5 H 4 - 0,40 mm	RG4400301		3,90
White			
5 H 1/0 - 0,50 mm	RG4421018		3,90
5 H 2 - 0,45 mm	RG4421019		3,90
Blue			
5 H 1/0 - 0,50 mm	RG4421020		3,90
5 H 2 - 0,45 mm	RG4421021		3,90

Trade Pack: x12



Specially for Small fish.

## MICROMIT® FLEURETTE

Model	Code	Gencod	RRP (€)
8 H 14	RG4418009		3,75
8 H 16	RG4418010		3,75
8 H 18	RG4418011		3,75

Trade Pack: x12



8 hooks

## MICROMIT® DIAMANTS BEADS

Model	Code	Gencod	RRP (€)
8 H 14 0,24 mm	RG4451814		4,60

Trade Pack: x12

# MITRAILLETES



8 hooks

MICROMIT® GLOW BEADS			
Model	Code	Gencod	RRP (€)
8 H 16 0,20 mm	RG4451816		4,10

Trade Pack: x12



Pack x3

MICROMIT® PEARLS			
Model	Code	Gencod	RRP (€)
8 H 16 0,20 mm	RG4452000		10,50

Trade Pack: x12



6 hooks.

MICROMIT® LARVA WHITE			
Model	Code	Gencod	RRP (€)
6 H 14 0,24 mm	RG4451614		5,05

Trade Pack: x12



5 hooks

MICROMIT® LARVA MULTI			
Model	Code	Gencod	RRP (€)
5 H 6 0,35 mm	RG4453506		5,05
6 H 4 0,45 mm	RG4453604		5,05
6 H 6 0,40 mm	RG4453706		5,05
6 H 6 0,30 mm	RG4453606		5,05
6 H 10 0,26 mm	RG4453610		5,05
6 H 12 0,24 mm	RG4453612		5,05
6 H 16 0,24 mm	RG4453616		5,05
6 H 14 0,24 mm	RG4453614		5,05

Trade Pack: x12



5 hooks

MICROMIT® LARVA PINK			
Model	Code	Gencod	RRP (€)
5 H 6 0,35 mm	RG4450506		5,05
6 H 6 0,40 mm	RG4450606		5,05

Trade Pack: x12



5 hooks

MICROMIT® LARVA GREEN			
Model	Code	Gencod	RRP (€)
5 H 6 0,35 mm	RG4454506		5,05
6 H 6 0,40 mm	RG4454606		5,05
6 H 10 0,26 mm	RG4454610		5,05
6 H 12 0,24 mm	RG4454612		5,05
6 H 14 0,24 mm	RG4454614		5,05

Trade Pack: x12



6 hooks.

MICROMIT® FRY			
Model	Code	Gencod	RRP (€)
6 H 10 0,26 mm	RG4452610		3,90
6 H 16 0,26 mm	RG4452616		3,90

Trade Pack: x12



6 hooks.

MICROMIT® GOLD			
Model	Code	Gencod	RRP (€)
6 H 6 0,35 mm	RG4450706		4,25
6 H 8 0,30 mm	RG4450708		4,25
6 H 4 0,40 mm	RG4450704		4,25

Trade Pack: x12



# MITRAILLETES



Recommended for fishing for bass, mackerel and other predators. Made with natural phosphorescent fish skin and gold colored hooks that imitate perfectly small Fry.

## MITRAILLETTE LEMON

Model	Code	Gencod	RRP (€)
6H 4	RG4421040		2,50
6H 6	RG4421041		2,50
6H 8	RG4421042		2,50
6H 10	RG4421043		2,50
6H 12	RG4421044		2,50
6H 14	RG4421045		2,50

Trade Pack: x10



Specially designed for forage fish that appear at the time summer in many estuaries.

## MITRAILLETTE AVEIRO

Model	Code	Gencod	RRP (€)
6H 12	RG4421047		2,50
6H 14	RG4421048		2,50
6H 16	RG4421049		2,60
6H 18	RG4421050		2,60

Trade Pack: x10



Quality comparable to Lemon rigging, but with a spectrum of flashes that captures attention of fish at times of little activity.

## MITRAILLETTE ESTRELLA

Model	Code	Gencod	RRP (€)
6H 4	RG4421037		2,50
6H 6	RG4421038		2,50
6H 8	RG4421039		2,50

Trade Pack: x10



Ideal for seabass fishing, horse mackerel, mackerel and other predators. Made with natural phosphorescent fish skin and golden hooks that perfectly imitate small minnows.

## MITRAILLETTE FISH SKIN

Model	Code	Gencod	RRP (€)
6H 10	RG4421034		2,50
6H 12	RG4421035		2,50
6H 14	RG4421036		2,50

Trade Pack: x10



Suitable for catching small fish fodder (girelle, mackerel, etc.). Mounting on a hook in size 16.

## MITRAILLETTE MICRO

Model	Code	Gencod	RRP (€)
6H 16	RG4421046		2,60

Trade Pack: x10



Imitation Fry.

## FISPO HEGENE GOLD

Model	Code	Gencod	RRP (€)
5 H 4 0,25 mm	RG4414004		4,95

Trade Pack: x12



Loop assembly. Ideal for perch.

## TWISTER HEGENE

Model	Code	Gencod	RRP (€)
5 H 4 0,25 mm	RG4414000		5,75

Trade Pack: x12



Specially for difficult fish.

## ZURICHSEEHEGENE

Model	Code	Gencod	RRP (€)
5 H 12 0,25 mm	RG4414008		7,55

Trade Pack: x12

# MITRAILLETES

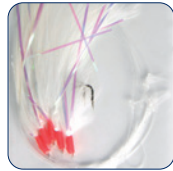

White



Blue

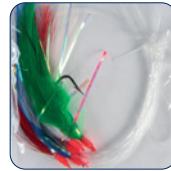

Multi



Pink

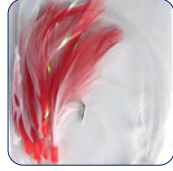

Red & White



Red & Yellow



Red



Green

## MITRAILLETTE® ECO

Model	Code	Gencod	RRP (€)	Code	Gencod	RRP (€)
		White			Blue	
5H 1/0	RG4417002		2,65	RG4417003		2,65
		Multi			Pink	
5H 1/0	RG4417004		2,65	RG4417005		2,65
		Red			Red & White	
5H 1/0	RG4417008		2,65	RG4417006		2,65
		Red & Yellow			Green	
5H 1/0	RG4417007		2,65	RG4417009		2,65

Trade Pack: x10



5 Hooks

## MITRAFLASH® ECO AURORA 135 cm

Model	Code	Gencod	RRP (€)
5H 1/0	RG4417000		2,65
5H 2/0	RG4417011		2,65

Trade Pack: x10



5 Hooks

## MITRARGENT ECO 135 cm

Model	Code	Gencod	RRP (€)
5H 1/0	RG4418005		2,65

Trade Pack: x10



## MITRAILLETTE® ECO KIT x5

Model	Code	Gencod	RRP (€)
		Assorted	
5H 1/0	RG4417010		10,90

Trade Pack: x10



Assortment kit consisting of:

- 3 Aurora 5H 1/0
- 2 Multi 5H 1/0

## KIT 5 MITRAFLASH® ECO AURORA

Model	Code	Gencod	RRP (€)
5H 1/0	RG4417001		10,90

Trade Pack: x10







# JIGS

## ANGUILL' JIGGER®



Anguill' Jigger® is the combination of a Dip Jigger® with a natural rubber Anguill'anguillon. This lure offers a bigger bite to predators and swims, even at low speeds. Very effective for Bass, Plaice and Cod. Holographic Finishes- 3D Eye.

ANGUILL' JIGGER®						
Color	Code	Gencod	Code	Gencod	Code	Gencod
	9,50 CM - 60 G		10,50 CM - 80 G		12 CM - 120 G	
AYU	RG2420063		RG2420083		RG2420123	
CH	RG2420060		RG2420080		RG2420120	
CHR	RG2402077		RG2402078		RG2402079	
RBLK	RG2420061		RG2420081		RG2420121	
SRD	RG2420062		RG2420082		RG2420122	
<b>RRP (€)</b>	<b>7,90</b>		<b>9,50</b>		<b>10,90</b>	
	13,50 CM - 160 G		14,50 CM - 200 G			
AYU	RG2420163		RG2420203			
CH	RG2420160		RG2420200			
CHR	RG2402080		RG2402081			
RBLK	RG2420161		RG2420201			
SRD	RG2420162		RG2420202			
<b>RRP (€)</b>	<b>12,50</b>		<b>13,70</b>			

Trade Pack: x5

AYU - Ayu ; CH - Chartreuse ;  
RBLK - Red Black ; SRD - Sardine





# JIGS



## FAT JIG

The FAT JIG as the name suggests was designed to be heavy or rather compact! The Ragot range of spoons and jigs is comprehensive, but to complete it, it was necessary to think "density". Designed as a dense yet compact lure, the FAT JIG casts very well, provide formidable efficiency to quickly reach the depths and is not too imposing to offer resistant in the current. Natural or Flashy colours and armed with an assist hook and a simple in-line, the FAT JIG proved during the tests to be a formidable weapon on all our marine predators, especially Plaice and Bass.

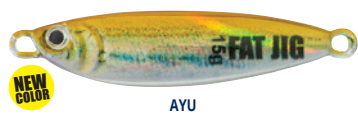

AYU

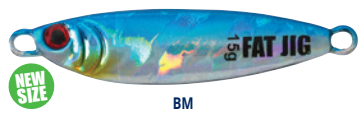

BM



BS

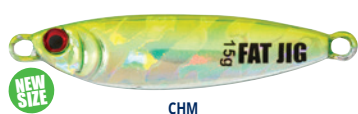

CHM

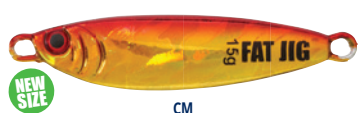

CM

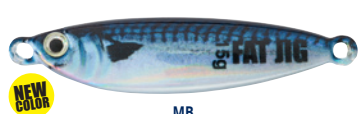

MB



PM



RB



RHM



RW

AYU - Ayu ; BM - Blue Metal ;  
 BS - Blue Sardine ; CHM -  
 Chartreuse Metal ; CM - Copper  
 Metal ; MB - Mackerel Blue ;  
 PM - pink metal ; RB - Rainbow ;  
 RHM - Red Head Metal ;  
 RW - Red White

FAT JIG					
Color	Code	Gencod		Code	Gencod
		5 CM - 15 G		5 CM - 25 G	
AYU	RG2402158			RG2402083	
BM	RG2402153			RG2402059	
BS	RG2402151			RG2402011	
CHM	RG2402155			RG2402061	
CM	RG2402156			RG2402062	
MB	RG2402157			RG2402082	
PM	RG2402154			RG2402060	
RB	RG2402150			RG2402010	
RHM	RG2402152			RG2402058	
RW	RG2402159			RG2402160	
RRP (€)		7,90		8,10	
		5,80 CM - 40 G		6,70 CM - 60 G	
AYU	RG2402085			RG2402087	
BM	RG2402064			RG2402069	
BS	RG2402014			RG2402017	
CHM	RG2402066			RG2402071	
CM	RG2402067			RG2402072	
MB	RG2402084			RG2402086	
PM	RG2402065			RG2402070	
RB	RG2402013			RG2402016	
RHM	RG2402063			RG2402068	
RW	RG2402161			RG2402162	
RRP (€)		8,90		9,30	
		7 CM - 80 G			
AYU	RG2402097				
BM	RG2402092				
BS	RG2402089				
CHM	RG2402094				
CM	RG2402095				
MB	RG2402096				
PM	RG2402093				
RB	RG2402088				
RHM	RG2402091				
RW	RG2402090				
RRP (€)		9,90			

Trade Pack: x5

**NEW  
2024**

## FIT JIG

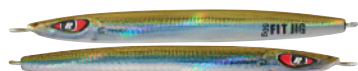

AYU



BM



BS

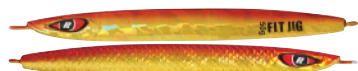

CM

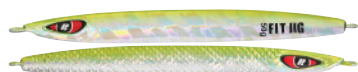

CHM

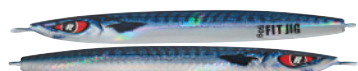

MB



PM

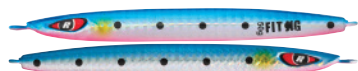

RB



RH



The Fit Jig has been designed to meet the requirements of fishing in the Atlantic and Mediterranean. Ideal for precision fishing where you need to position the lure close to a wreck or shoal of fish. The Fit Jig butterflies in the first few meters and then enters into a quick descent to reach the desired fishing area. This attribute makes it possible to get as close as possible to the preferred position. Once the lure has arrived at the desired location, it is during the retrieve that it excels as it rises quickly like a fish trying to escape for 5 to 6 meters, creating lot attractive and erratic movement. An asymmetrical body design, one face with a curve and scales, whilst another face angled and smooth, is the key to the lures action. Armed with an ASSIST HOOKS and a single VMC hook 7117 TI, the FIT JIG has proved very effective on various marine species, when either boat fishing or from the shore.

FIT JIG					
Color	Code	50 G		100 G	
		Gencod		Gencod	
AYU	RG2402106			RG2402115	
BM	RG2402101			RG2402110	
BS	RG2402099			RG2402108	
CHM	RG2402103			RG2402112	
CM	RG2402104			RG2402113	
MB	RG2402105			RG2402114	
PM	RG2402102			RG2402111	
RB	RG2402098			RG2402107	
RH	RG2402100			RG2402109	
<b>RRP (€)</b>		<b>8,90</b>		<b>10,90</b>	
		150 G		200 G	
AYU	RG2402124			RG2402133	
BM	RG2402119			RG2402128	
BS	RG2402117			RG2402126	
CHM	RG2402121			RG2402130	
CM	RG2402122			RG2402131	
MB	RG2402123			RG2402132	
PM	RG2402120			RG2402129	
RB	RG2402116			RG2402125	
RH	RG2402118			RG2402127	
<b>RRP (€)</b>		<b>12,90</b>		<b>15,90</b>	

Trade Pack: x5

**AYU** - Ayu ; **BM** - Blue Metal ;  
**BS** - Blue Sardine ; **CHM** -  
 Chartreuse Metal ; **CM** - Copper  
 Metal ; **MB** - Mackerel Blue ;  
**PM** - Pink Metal ; **RB** - Rainbow ;  
**RHM** - Red Head Metal

## MICRO HERRING



Very versatile micro Jig from the shore or a boat and who can target many predators. The finish is neat, extremely strong paint, the eye is sealed in lead despite its minimal dimensions. Armed with 2 hooks, on the front a single hook, VMC 7122 PTFE size 6, connected by a solid ring on a 28/100° PE braid with a 20 kg strength, and on the back a treble hook, VMC 7548 BN size 12. It can reach a great distance with ease. Two possibilities for animation are available to you, for this the point of attachment will not be the same. On the front, attach to the solid ring, it allows you to jig, where its swimming is very fast and at the same time very erratic. This style is easier from a boat, freelining down before Jigging the rig. On the back, (in this case it is highly recommended to remove the triple hook and the split ring). It allows you to cast the lure from the shore or boat but with a linear animation. All you have to do is to cast and create a pulse on the tip of the rod, and release it without controlling the descent, the perfectly balanced Micro Herring slowly descends to the bottom while fluttering. 10 colors are available to anglers that will cover all requirements.

MICRO HERRING					
Color	Code	Gencod	Color	Code	Gencod
4 CM - 6 G					
B	RG2421007		HP	RG2421005	
BM	RG2421003		LG	RG2421009	
BS	RG2421004		PP	RG2421001	
CH	RG2421002		S	RG2421008	
GM	RG2421000		WH	RG2421006	
<b>RRP (€)</b>	<b>6,90</b>		<b>RRP (€)</b>	<b>6,90</b>	

Trade Pack: x5

## MINI HERRING



One of the most used by professionals spoons now available in small size. Hooked with VMC 7237 Needle Sharp.

MINI HERRING							
Color	Code	Gencod	Code	Gencod	Code	Gencod	
		5 CM - 10 G		5,50 CM - 15 G		6 CM - 20 G	
B	RG2401007		RG2401507		RG2402007		
BM	RG2401003		RG2401503		RG2402003		
BS	RG2401004		RG2401504		RG2402004		
CH	RG2401002		RG2401502		RG2402002		
GM	RG2401000		RG2401500		RG2402000		
HP	RG2401005		RG2401505		RG2402005		
LG	RG2401009		RG2401509		RG2402009		
S	RG2401008		RG2401508		RG2402008		
WH	RG2401006		RG2401506		RG2402006		
<b>RRP (€)</b>	<b>5,30</b>		<b>5,80</b>		<b>6,25</b>		

Trade Pack: x5

## HERRING®

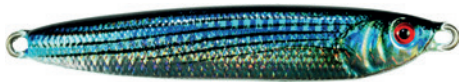

B

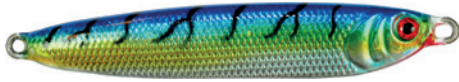

BM

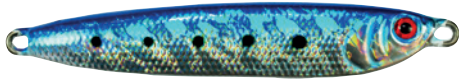

BS

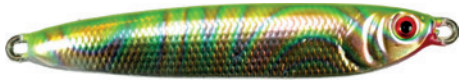

CH

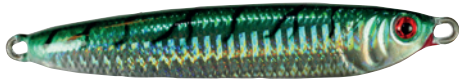

GM



HP

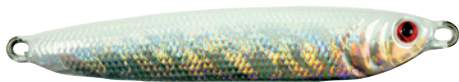

LG



PP

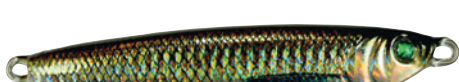

S



WH



One of the most used spoons by professionals! Available from 25 to 250g, it is formidable on bars, lieus, cod... Wide and flat profile. Highly glittering colors and very attractive streaks that trigger the attacks even in dark waters. 3D eyes. Triple hook very resistant.

HERRING®					
Color	Code	Gencod		Code	Gencod
7 CM - 25 G			7,50 CM - 35 G		
B	RG2400022			RG2400037	
BM	RG2400018			RG2400033	
BS	RG2400019			RG2400034	
CH	RG2400017			RG2400032	
GM	RG2400015			RG2400030	
HP	RG2400020			RG2400035	
LG	RG2400024			RG2400039	
PP	-	-		-	-
S	RG2400023			RG2400038	
WH	RG2400021			RG2400036	
<b>RRP (€)</b>		<b>6,35</b>		<b>7,05</b>	
9 CM - 50 G			9,50 CM - 75 G		
B	RG2400057			RG2400077	
BM	RG2400053			RG2400073	
BS	RG2400054			RG2400074	
CH	RG2400052			RG2400072	
GM	RG2400050			RG2400070	
HP	RG2400055			RG2400075	
LG	RG2400059			RG2400079	
PP	RG2400051			RG2400071	
S	RG2400058			RG2400078	
WH	RG2400056			RG2400076	
<b>RRP (€)</b>		<b>7,40</b>		<b>7,85</b>	
10 CM - 100 G			12 CM - 150 G		
B	RG2400107			RG2400157	
BM	RG2400103			RG2400153	
BS	RG2400104			RG2400154	
CH	RG2400102			RG2400152	
GM	RG2400100			RG2400150	
HP	RG2400105			RG2400155	
LG	RG2400109			RG2400159	
PP	RG2400101			-	-
S	RG2400108			RG2400158	
WH	RG2400106			RG2400156	
<b>RRP (€)</b>		<b>9,10</b>		<b>11,30</b>	

Trade Pack: x5

**B** - Bonito ; **BM** - Blue Mackerel ;  
**BS** - Blue Sardine ; **CH** - Chartreuse ;  
**GM** - Green Mackerel ; **HP** - Hot Pink ;  
**LG** - Glow ; **PP** - Pearl Purple ; **RB** - Red Black ;  
**S** - Shad ; **WH** - White Holo



## YANN®



Its special and secret alloy causes sounds particular attractives, not like brass. Outstanding quality nickel plating that gives it an irresistible sparkle. Profile curved and refined. Weight distributed along the length to promote long throws and descent into "dead leaf".

YANN®									
Code	Size	Weight	Gencod	RRP (€)	Code	Size	Weight	Gencod	RRP (€)
RG2490015	4 cm	15 g		4,30	RG2490090	10 cm	90 g		7,65
RG2490020	5,50 cm	20 g		4,55	RG2490120	10,50 cm	120 g		8,80
RG2490030	6,50 cm	30 g		4,65	RG2490150	11,50 cm	150 g		9,05
RG2490040	8 cm	40 g		5,35	RG2490200	12 cm	200 g		10,75
RG2490050	8,50 cm	50 g		5,55	RG2490250	13,50 cm	250 g		12,60
RG2490065	9,50 cm	65 g		5,90	RG2490350	15 cm	350 g		16,65

Trade Pack: x5

## YANNLIT®



Its fish shape, its perfect undulating curve, its superb and unalterable dressing make the Yannlit® spoon, a heavy spoon very powerful and attractive.

YANNLIT®				
Code	Size	Weight	Gencod	RRP (€)
RG2496020	5,50 cm	20 g		4,60
RG2496030	6,50 cm	30 g		6,35
RG2496040	7,50 cm	40 g		6,95
RG2496050	8 cm	50 g		7,30
RG2496065	9 cm	65 g		8,00
RG2496090	10,50 cm	90 g		9,15
RG2496120	10,50 cm	120 g		9,70
RG2496150	11 cm	150 g		10,50
RG2496200	12 cm	200 g		12,85

Trade Pack: x5

## MITRALITE®



Its highly studied profile gives it an undulating action and allows distant shots. Its curved shape and its anti-roll border ensure a very effective antivibrill. Its flanks simulate fish scales. Do not forget to use it to catch perch, pike and Zander. You will be surprised!

MITRALITE®				
Code	Size	Weight	Gencod	RRP (€)
RG2499330	6 cm	30 g		6,70
RG2499340	6,50 cm	40 g		6,80
RG2499350	7 cm	50 g		6,90
RG2499360	7,50 cm	65 g		7,40
RG2499390	9 cm	90 g		8,40

Trade Pack: x5

## MITRASPOON®

The faller of bars, the one that provokes thrusts adrenaline to many fishermen. Excellent also for perch, pike, zander, etc.



MITRASPOON®									
Color	Code	Gencod	Code	Gencod	Code	Gencod	Code	Gencod	
	4,50 CM - 12 G		5,50 CM - 18 G		6,70 CM - 25 G		7 CM - 35 G		
Silver	RG2494012		RG2494018		RG2494025		RG2494035		
AYU	RG2495012		RG2495018		RG2495025		RG2495035		
Blue	RG2493012		RG2493018		RG2493025		RG2493035		
RRP (€)	3,85		4,05		4,85		5,35		
	8 CM - 50 G		9 CM - 70 G		10 CM - 85 G		11 CM - 130 G		
Silver	RG2494050		RG2494070		RG2494085		RG2494030		
AYU	RG2495050		RG2495070		RG2495085		RG2495130		
Blue	RG2493050		RG2493070		RG2493085		RG2493130		
RRP (€)	6,24		6,70		8,00		10,40		

Trade Pack: x5

## SNACK®



His profile allows him a slow descent into 'dead leaf', imitating the uncertain swimming of a wounded fish. It gives excellent results in shallow waters. Manufactured from Nickel.

SNACK®				
Code	Size	Weight	Gencod	RRP (€)
RG2499105	3,50 cm	5 g		3,15
RG2499110	5 cm	10 g		3,60
RG2499115	6 cm	15 g		3,85
RG2499120	7 cm	20 g		4,05

Trade Pack: x5

## MACKEREL SPOON



Hammered model design, providing reflections and creating an undulating and trembling swimming action, making it irresistible for many sea fish. To be used behind a Mitraillette or on a trolling line.

MACKEREL SPOON x2			
Code	Size	Gencod	RRP (€)
RG2402134	3,50 cm		3,50
RG2402135	4 cm		3,90
RG2402136	5 cm		3,90
RG2402137	6 cm		4,90
RG2402138	7 cm		4,90
RG2402139	8 cm		5,90

Trade Pack: x5

# RAGTENYA

Tenya fishing is still a complex and more technical fishery than you might think. It was interesting to create a new tenya that would meet the requirements of experienced anglers but also make this fishing more accessible and entertaining. This is why this new «RAGTENYA» was created. The creation of this tenya brings a real change in this fishing, the novelties proposed on this model make it «UNIQUE». It had to be technical for experienced anglers but also versatile for all other anglers looking for beautiful fish and new sensations.

This tenya has many assets:

- The shoe shape of the tenya gives it a very good stability whether it is used in a free descent (i.e. open pick-up and let it go down) or in a controlled descent (let the line slide between the fingers to slow down the descent slightly). It will always land perfectly on the ground.
- The "beak« shape of its front end allows it to make small jerks when the angler wants to without hitting the bottom and remaining as natural as possible, as if the shrimp were making a small jump to move. This makes it possible to trigger the bite at certain times.
- The tenya has a very special feature: its noisy beads inside the head; never seen on a tenya before. The emission of high and low frequency sounds triggers the curiosity or irritation of the fish and awakens their aggressiveness. This brings more hits because they don't just attack because they are hungry.
- Its attractive foam at the head. The foam absorber allows the bait to be diffused, making the fish less wary of the bait because it looks more real. The fish will be more determined and have a better grip on the tenya.
- His armament. It has a main hook and is equipped with a double hook set-up. This is a great way to get a hit, which is what all anglers are looking for. It is always reassuring to have an extra hook, which makes it once again unique on the current market.
- The eye signal is placed on the top of the body to enhance the attraction.

It will be offered in several colours, well studied according to the funds and the different fishing sectors. This tenya has been thought/tested and studied for the success of this fishing, a product that offers many novelties. It will allow every angler to have a good time on the water, try it and make your own opinion.



RAGTENYA PINK			
Code	Weight	Gencod	RRP (€)
RG2402035	20 g		8,70
RG2402036	30 g		10,30
RG2402037	50 g		11,45
RG2402038	75 g		12,60
RG2402039	100 g		13,75

Trade Pack: x5



RAGTENYA GOLD			
Code	Weight	Gencod	RRP (€)
RG2402028	20 g		8,70
RG2402029	30 g		10,30
RG2402030	50 g		11,45
RG2402031	75 g		12,60
RG2402032	100 g		13,75

Trade Pack: x5



RAGTENYA SHRIMP			
Code	Weight	Gencod	RRP (€)
RG2402020	15 g		9,30
RG2402021	20 g		9,90
RG2402022	30 g		11,50
RG2402023	50 g		12,60
RG2402024	75 g		13,90
RG2402025	100 g		14,90

Trade Pack: x5



RAGTENYA FLUO ORANGE			
Code	Weight	Gencod	RRP (€)
RG2402041	15 g		8,00
RG2402042	20 g		8,70
RG2402043	30 g		10,30
RG2402044	50 g		11,45
RG2402045	75 g		12,60
RG2402046	100 g		13,75

Trade Pack: x5

# RAGTENYA



RAGTENYA LUMINOUS			
Code	Weight	Gencod	RRP (€)
RG2402073	30 g		10,90
RG2402074	50 g		11,50
RG2402075	75 g		11,90
RG2402076	100 g		13,20

Trade Pack: x5



Spare rig to replace the RAGTENYA rig. Available in 4 sizes.

RAGTENYA SPARE RIGS x2			
Code	N°	Gencod	RRP (€)
RG2402055	2		4,60
RG2402054	1		4,60
RG2402056	1/0		5,70
RG2402057	2/0		5,70

Trade Pack: x5

# RAGTENYA XL

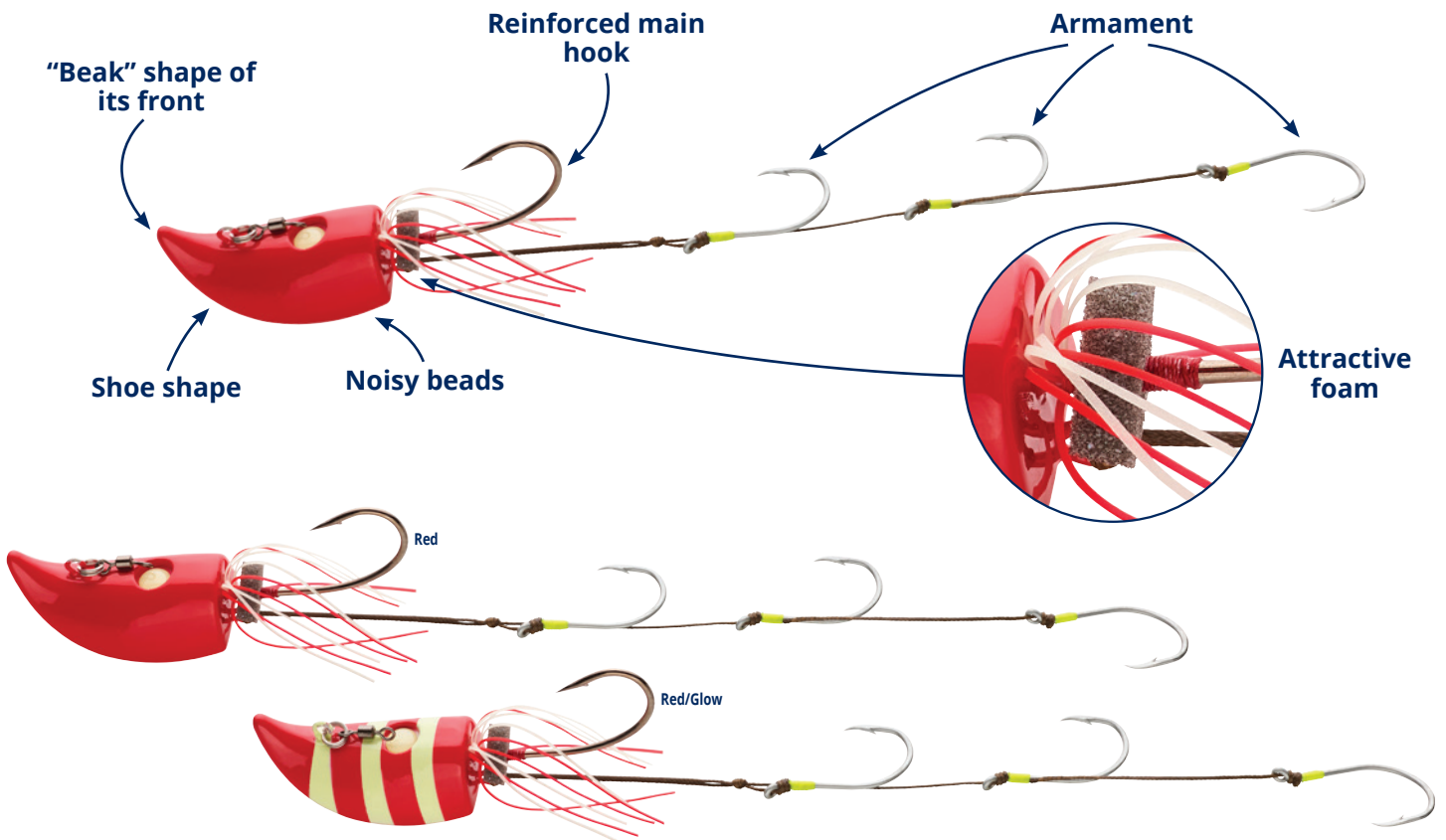

**NEW 2024**

The XL VERSION of the existing TENYA, to be used with large baits. Utilising VMC 8299 PS hooks, with the main one being reinforced. A choice of two colours Red, Red & glow, with five sizes – 80, 100, 150, 200 & 250g.

RAGTENYA RED				
Code	Weight	N°H	Gencod	RRP (€)
RG2402140	80 g	3/0		13,90
RG2402141	100 g	3/0		15,90
RG2402142	150 g	4/0		17,90
RG2402143	200 g	4/0		18,90
RG2402144	250 g	5/0		20,90

Trade Pack: x5

RAGTENYA RED/GLOW				
Code	Weight	N°H	Gencod	RRP (€)
RG2402145	80 g	3/0		13,90
RG2402146	100 g	3/0		15,90
RG2402147	150 g	4/0		17,90
RG2402148	200 g	4/0		18,90
RG2402149	250 g	5/0		20,90

Trade Pack: x5



## ANGUILL'® NORMANDE BRIGHT

For years, the artificial eel remains one of the most popular lures. Its profile is reminiscent of worms or small eels much sought after by bars and places.

- Arc provides the eel with a fascinating wave motion for predators.
- Tube made of soft rubber, strong and elastic.
- The «Brill», iridescent filament increases attractiveness.
- Cut and length bevel studied for a perfect balance

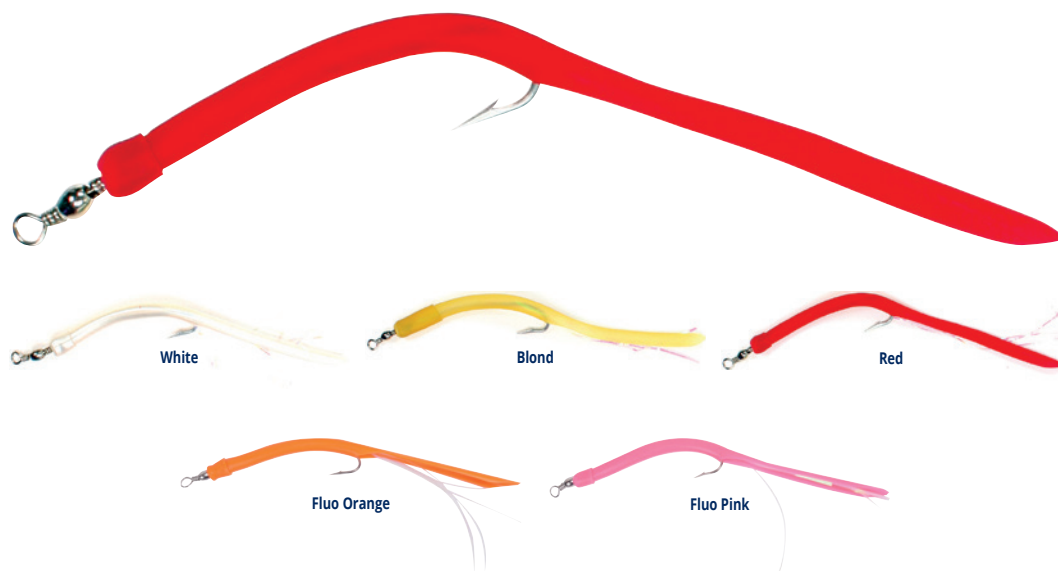

ANGUILL'® NORMANDE BRIGHT - 3 per Bag						
Color	Code	Gencod	Code	Gencod	Code	Gencod
	7,50 CM - N°H 5		9,30 CM - N°H 2		9,50 CM - N°H 1	
White	RG7200501		RG7200201		RG7200101	
Blond	RG7200531		RG7200231		RG7200131	
Red	RG7200541		RG7200241		RG7200141	
<b>RRP (€)</b>	<b>5,05</b>		<b>5,30</b>		<b>5,55</b>	
	10,50 CM - N°H 1/0		12,50 CM - N°H 2/0		14,50 CM - N°H 3/0	
White	RG7201001		RG7202001		RG7203001	
Blond	RG7201031		RG7202031		RG7203031	
Fluo Orange	RG7207020		RG7207021		RG7207022	
Fluo Pink	RG7207060		RG7207061		RG7207062	
Red	RG7201041		RG7202041		RG7203041	
<b>RRP (€)</b>	<b>5,90</b>		<b>6,00</b>		<b>7,00</b>	
	16 CM - N°H 4/0		18 CM - N°H 6/0		21 CM - N°H 8/0	
White	RG7204001		RG7206001		-	-
Blond	RG7204031		RG7206031		-	-
Fluo Orange	RG7207023		RG7207024		RG3921022	
Fluo Pink	RG7207063		RG7207064		RG3921023	
Red	RG7204051		RG7206051		RG3921020	
<b>RRP (€)</b>	<b>7,25</b>		<b>8,05</b>		<b>11,95</b>	

Trade Pack: x10

## ANGUILL'® TUB



- A flexible and solid tube of 3 metres to make your Eel
- Material: latex or silicone

ANGUILL'® TUB						
Color	Code	Gencod	Code	Gencod	Code	Gencod
	3x5 mm			5x7 mm		
White	RG7230305		RG7230505			
Blond	RG7230304		RG7230504			
Fluo Orange	-	-	RG7221015			
Fluo Pink	-	-	RG7221016			
Red	RG7230303		RG7230503			
<b>RRP (€)</b>	<b>10,15</b>			<b>11,70</b>		

Trade Pack: x5

# LURES

## NEW 2024 RAGLOU® HYBRID

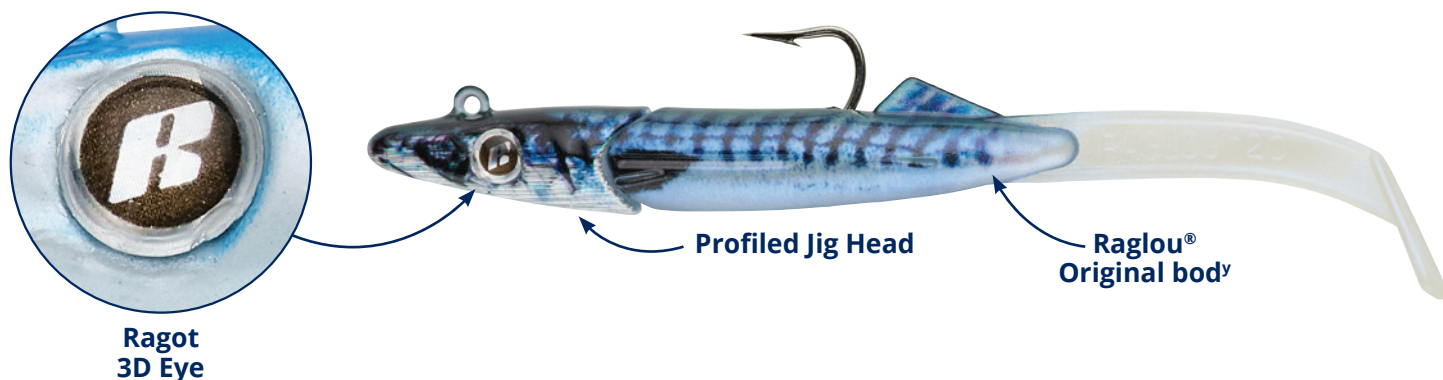

The RAGLOU lure family is expanding this year with a hybrid version that combines a leaded head and the body of the traditional RAGLOU. This lure can be used like its predecessors behind a Buldo, but especially on its own either casting or vertical fishing. It works well around underwater features using a linear retrieve. Built using VMC 9255 TI hooks for the ultimate in sharpness and strength. A wide choice of sizes and colours including the realistic AYU, BM and GM patterns and finished with 3D eyes.

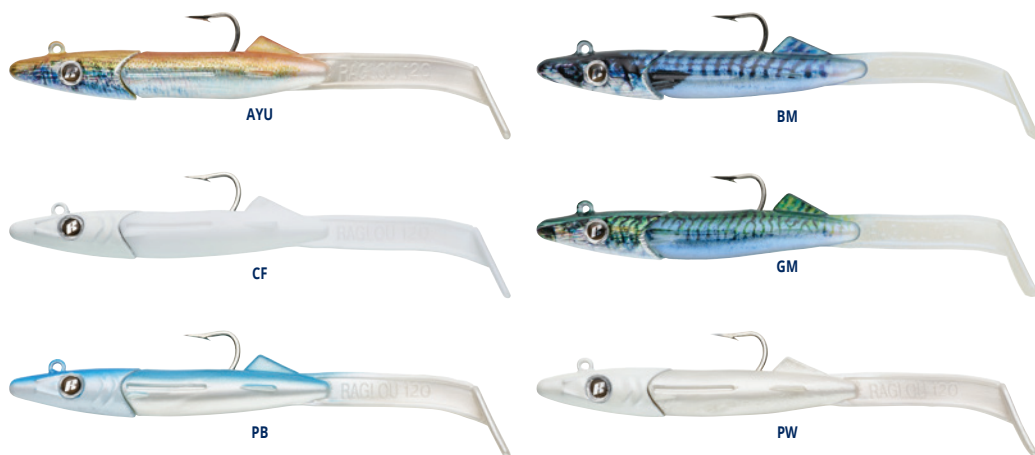

### Specification:

Size	6,5 cm	8,5 cm	10,5 cm	12 cm
Hook N°	4	1	1/0	2/0
Head weight	3,4 g	6,4 g	11,4 g	20 g
Body weight	0,8 g	2 g	3,2 g	5 g
Total weight	4,2 g	8,4 g	14,6 g	25 g

### RAGLOU® HYBRID

Color	Code	Gencod	Code	Gencod	Code	Gencod	Code	Gencod
	6,50 CM - 2		8,50 CM - 2		10,50 CM - 1/0		12 CM - 2/0	
	2 PER BLISTER		2 PER BLISTER		2 PER BLISTER		2 PER BLISTER	
AYU	RG3921170		RG3921176		RG3921182		RG3921188	
BM	RG3921168		RG3921174		RG3921180		RG3921186	
CF	RG3921167		RG3921173		RG3921179		RG3921185	
GM	RG3921169		RG3921175		RG3921181		RG3921187	
PB	RG3921165		RG3921171		RG3921177		RG3921183	
PW	RG3921166		RG3921172		RG3921178		RG3921184	
RRP (€)	6,90		8,10		8,60		9,50	

Trade Pack: x6

AYU - Ayu ; BM - Blue Mackerel ; CF -Crème Fraiche ; GM - Green Mackerel ;  
PB - Pearl Blue ; PW - Pearl White

# LURES

## RAGLOU® 55



The movement of the body associated with that of the tail transmits low frequency vibrations. These vibratory waves call predators. The profile and the color transmit the visual signals. These signals trigger the final attack. Each Raglou has a particular flexibility.



RAGLOU® - 5,50 cm - N°H 8					
Color	Code	Gencod	Code	Gencod	
3 PER BLISTER			BOX OF 25		
AYU	RG3903305		-	-	
BS	RG3903825		-	-	
CF	RG3903805		RG3903806		
GRG	RG3921145		RG3921151		
LC	RG3903835		-	-	
LG	RG3903545		RG3903546		
PB	RG3903205		RG3903206		
PG	-	-	RG3903506		
PGY	-	-	RG3903106		
PR	RG3903405		RG3903406		
PW	RG3903005		RG3903006		
SG HG	RG3903115		RG3903116		
<b>RRP (€)</b>	<b>7,20</b>		<b>50,65</b>		
	Trade Pack: x6		Trade Pack: x1		

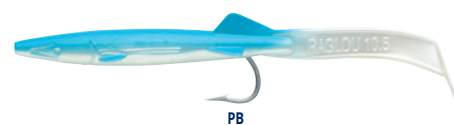
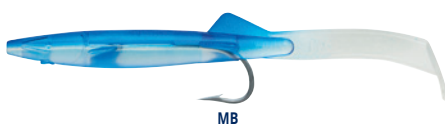
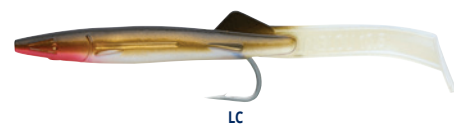
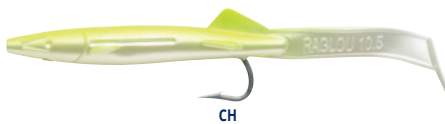
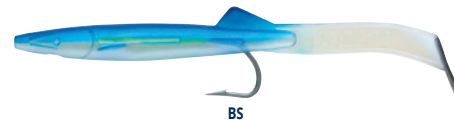
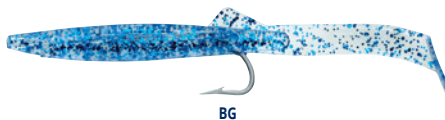
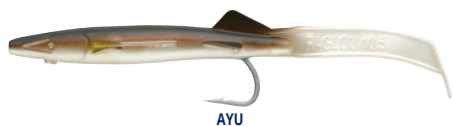

AYU - Ayu ; BG - Glitter Blue ; BS - Blue Sardine ; CF - Crème Fraiche ; CH - Chartreuse ; CP - Champagne ; CU - Copper ; GRG - Green Glitter ; LC - Sandeel ; LG - Glow ; MB - Blue Fry ; PB - Pearl Blue ;

# LURES

## RAGLOU® 65



The movement of the body associated with that of the tail transmits low frequency vibrations. These vibratory waves call predators. The profile and the color transmit the visual signals. These signals trigger the final attack. Each Raglou has a particular flexibility.

RAGLOU® - 6,50 cm - N°H 2				
Color	Code	Gencod	Code	Gencod
3 PER BLISTER			BOX OF 25	
AYU	RG3905305		RG3905306	
BG	RG3921076		RG3921081	
BS	RG3905825		RG3905826	
CF	RG3905805		RG3905806	
CH	RG3921028		RG3921032	
CP	RG3921077		RG3921082	
GRG	RG3921146		RG3921152	
LC	RG3905835		RG3905836	
LG	RG3905545		RG3905546	
MB	-	-	RG3905866	
PB	RG3905205		RG3905206	
PG	RG3905505		RG3905506	
PGY	RG3905105		RG3905106	
PP	RG3921030		RG3921034	
PR	RG3905405		RG3905406	
PW	RG3905005		RG3905006	
RH	RG3921075		RG3921080	
SG HG	RG3905115		RG3905116	
SR	RG3921029		RG3921033	
TS	RG3921078		RG3921083	
TSP	RG3921079		RG3921084	
TSPK	RG3921157		RG3921161	
<b>RRP (€)</b>	<b>8,30</b>		<b>59,50</b>	
	Trade Pack: x6		Trade Pack: x1	



PG



PGY



PP



PR



PW



RH



SG HG



SR



TS



TSP



TSPK

**PG** - Pearl Green ; **PGY** - Pearl Grey Dark ; **PP** - Pearl Pink ; **PR** - Pearl Red ; **PW** - Pearl White ; **RH** - Red Head ; **SG HG** - Glitter Silver ; **SR** - Sunrise ; **TSB** - Transparent Blue ; **TSP** - Transparent Purple ; **TSPK** - Transparent Pink



# LURES

## RAGLOU® 85



The movement of the body associated with that of the tail transmits low frequency vibrations. These vibratory waves call predators. The profile and the color transmit the visual signals. These signals trigger the final attack. Each Raglou has a particular flexibility.



RAGLOU® - 8,50 cm - N°H 2				
Color	Code	Gencod	Code	Gencod
3 PER BLISTER			BOX OF 25	
AYU	RG3908305		RG3908306	
BG	RG3921086		RG3921091	
BS	RG3908825		RG3908826	
CF	RG3908805		RG3908806	
CH	RG3921040		RG3921044	
CP	RG3921087		RG3921092	
CU	RG3908919		RG3908918	
GRG	RG3921147		RG3921153	
LC	RG3908835		RG3908836	
LG	RG3908545		RG3908546	
MB	-	-	RG3908911	
PB	RG3908205		RG3908206	
PG	RG3908505		RG3908506	
PGY	RG3908105		RG3908106	
PP	RG3921042		RG3921046	
PR	RG3908405		RG3908406	
PW	RG3908005		RG3908006	
RH	RG3921085		RG3921090	
SG HG	RG3908115		RG3908116	
SR	RG3921041		RG3921045	
TS	RG3921088		RG3921093	
TSP	RG3921089		RG3921094	
TSPK	RG3921158		RG3921162	
<b>RRP (€)</b>	<b>10,10</b>		<b>71,65</b>	
	Trade Pack: x6		Trade Pack: x1	

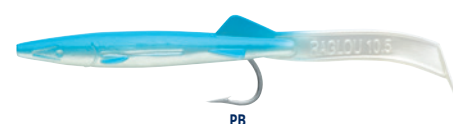
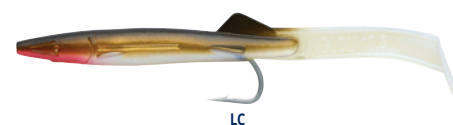
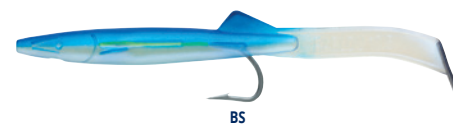
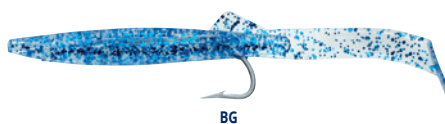
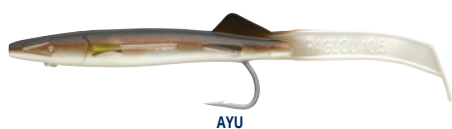

NEW COLOR

AYU - Ayu ; BG - Glitter Blue ; BS - Blue Sardine ; CF - Crème Fraîche ; CH - Chartreuse ; CP - Champagne ; CU - Copper ; GRG - Green Glitter ; LC - Sandeel ; LG - Glow ; MB - Blue Fry ; PB - Pearl Blue ;

# LURES

## RAGLOU® 105



The movement of the body associated with that of the tail transmits low frequency vibrations. These vibratory waves call predators. The profile and the color transmit the visual signals. These signals trigger the final attack. Each Raglou has a particular flexibility.



RAGLOU® - 10,50 cm - N°H 1/0				
Color	Code	Gencod	Code	Gencod
		3 PER BLISTER	BOX OF 25	
AYU	RG3901315		RG3901316	
BG	RG3921096		RG3921101	
BS	RG3901825		-	-
CF	RG3901905		RG3900806	
CH	RG3921052		RG3921056	
CP	RG3921097		RG3921102	
GRG	RG3921148		RG3921154	
LC	RG3901835		-	-
LG	RG3901645		RG3900546	
PB	RG3901305		RG3900206	
PG	RG3901915		RG3900506	
PGY	RG3901225		RG3900106	
PP	RG3921054		RG3921058	
PR	RG3901425		RG3900406	
PW	RG3901025		RG3900006	
RH	RG3921095		RG3921100	
SG HG	RG3901135		RG3900116	
SR	RG3921053		RG3921057	
TS	RG3921098		RG3921103	
TSP	RG3921099		RG3921104	
TSPK	RG3921159		RG3921163	
<b>RRP (€)</b>	<b>10,70</b>		<b>76,00</b>	
	Trade Pack: x6		Trade Pack: x1	



PG



PGY



PP



PR



PW



RH



SG HG



SR



TS



TSP



TSPK

**PG** - Pearl Green ; **PGY** - Pearl Grey Dark ; **PP** - Pearl Pink ; **PR** - Pearl Red ; **PW** - Pearl White ; **RH** - Red Head ; **SG HG** - Glitter Silver ; **SR** - Sunrise ; **TSB** - Transparent Blue ; **TSP** - Transparent Purple ; **TSPK** - Transparent Pink

# LURES

## RAGLOU® 120



The movement of the body associated with that of the tail transmits low frequency vibrations. These vibratory waves call predators. The profile and the color transmit the visual signals. These signals trigger the final attack. Each Raglou has a particular flexibility.



RAGLOU® - 12 cm - N°H 2/0					
Color	Code	Gencod	Code	Gencod	
3 PER BLISTER			BOX OF 25		
AYU	RG3902305		-	-	
BG	RG3921106		RG3921111		
BS	RG3902825		-	-	
CH	RG3921064		RG3921068		
CP	RG3921107		RG3921112		
GRG	RG3921149		RG3921155		
LC	RG3902835		-	-	
PB	RG3902205		-	-	
PGY	RG3902105		-	-	
PP	RG3921066		RG3921070		
PR	RG3902405		-	-	
PW	RG3902005		-	-	
RH	RG3921105		RG3921110		
SG HG	RG3902115		-	-	
SR	RG3921065		RG3921069		
TS	RG3921108		RG3921113		
TSP	RG3921109		RG3921114		
TSPK	RG3921160		RG3921164		
RRP (€)	11,40		79,40		
	Trade Pack: x6		Trade Pack: x1		

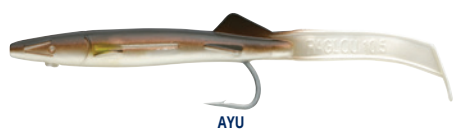

AYU



BG



BS



CF



CH



CP



CU



GRG

NEW COLOR



LC



LG



MB



PB

AYU - Ayu ; BG - Glitter Blue ; BS - Blue Sardine ; CF - Crème Fraîche ; CH - Chartreuse ; CP - Champagne ; CU - Copper ; GRG - Green Glitter ; LC - Sandeel ; LG - Glow ; MB - Blue Fry ; PB - Pearl Blue ;

# LURES

## RAGLOU® 140



The movement of the body associated with that of the tail transmits low frequency vibrations. These vibratory waves call predators. The profile and the color transmit the visual signals. These signals trigger the final attack. Each Raglou has a particular flexibility.

RAGLOU® - 14 cm - N°H 3/0					
Color	Code	Gencod	Code	Gencod	
	3 PER BLISTER			BOX OF 25	
AYU	RG3904305		-	-	
BS	RG3904825		-	-	
GRG	RG3921150		RG3921156		
LC	RG3904835		-	-	
PB	RG3904205		-	-	
PR	RG3904405		-	-	
PW	RG3904005		-	-	
SG HG	RG3904115		-	-	
<b>RRP (€)</b>	<b>12,60</b>			<b>84,90</b>	
	Trade Pack: x6			Trade Pack: x1	

## RAGLOU® 160

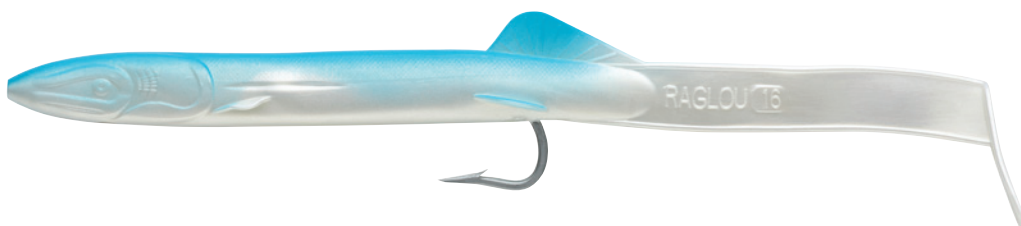

RAGLOU® - 16 cm - N°H 4/0						
Color	Code	Gencod	Color	Code	Gencod	
	3 PER BLISTER			3 PER BLISTER		
AYU	RG3906305		PB	RG3906205		
BS	RG3906825		PW	RG3906005		
LC	RG3906835					
<b>RRP (€)</b>	<b>13,10</b>			<b>RRP (€)</b>	<b>13,10</b>	
	Trade Pack: x6			Trade Pack: x6		



PG



PGY



PP



PR



PW



RH



SG HG



SR



TSB



TSP



TSPK

NEW COLOR

PG - Pearl Green ; PGY - Pearl Grey Dark ; PP - Pearl Pink ; PR - Pearl Red ; PW - Pearl White ; RH - Red Head ; SG HG - Glitter Silver ; SR - Sunrise ; TSB - Transparent Blue ; TSP - Transparent Purple ; TSPK - Transparent Pink



# LURES

## RAGLOU® TIGER



The movement of the body associated with that of the tail transmits low frequency vibrations. These vibratory waves call predators. The profile and the color transmit the visual signals. These signals trigger the final attack. Each Raglou has a particular flexibility.

RAGLOU® TIGER										
Color	Code	Gencod	Code	Gencod	Code	Gencod	Code	Gencod	Code	Gencod
5,50 CM - 8					6,50 CM - 2					
3 PER BLISTER			BOX OF 25		3 PER BLISTER			BOX OF 25		
TGB	RG3921115		RG3921118		RG3921121		RG3921124			
TGG	RG3921116		RG3921119		RG3921122		RG3921125			
TGO	<b>RG3921189</b>		<b>RG3921190</b>		<b>RG3921191</b>		<b>RG3921192</b>			
TGR	RG3921117		RG3921120		RG3921123		RG3921126			
<b>RRP (€)</b>	<b>8,20</b>		<b>51,65</b>		<b>8,55</b>		<b>60,15</b>			
	Trade Pack: x6		Trade Pack: x1		Trade Pack: x6		Trade Pack: x1			
8,50 CM - 2					10,50 CM - 1/0					
3 PER BLISTER			BOX OF 25		3 PER BLISTER			BOX OF 25		
TGB	RG3921127		RG3921130		RG3921133		RG3921136			
TGG	RG3921128		RG3921131		RG3921134		RG3921137			
TGO	<b>RG3921193</b>		<b>RG3921194</b>		<b>RG3921195</b>		<b>RG3921196</b>			
TGR	RG3921129		RG3921132		RG3921135		RG3921138			
<b>RRP (€)</b>	<b>10,40</b>		<b>72,60</b>		<b>11,00</b>		<b>77,30</b>			
	Trade Pack: x6		Trade Pack: x1		Trade Pack: x6		Trade Pack: x1			
12 CM - 2/0										
3 PER BLISTER			BOX OF 25							
TGB	RG3921139		RG3921142							
TGG	RG3921140		RG3921143							
TGO	<b>RG3921197</b>		<b>RG3921198</b>							
TGR	RG3921141		RG3921144							
<b>RRP (€)</b>	<b>12,40</b>		<b>81,90</b>							
	Trade Pack: x6		Trade Pack: x1							

**TGB** - Tiger Blue ; **TGG** - Tiger Green ; **TGR** - Tiger Red ;  
**TGO** - Tiger Orange

# LURES

## RAGLOU® SPID



Ensures great swimming stability. Ham.Spид tinned 1,5g N ° 4 on the 6,5 cm. Ham.Spид tinned 3g N ° 1 on the 8,5 cm. Fish wanted: Bar, Wolf, Mackerel, Horse mackerel, Place, Cod, Shad, Oblade, Bonite.

RAGLOU® SPID				
Color	Code	Gencod	Code	Gencod
	6,50 CM - 2		8,50 CM - 2	
	2 PER BLISTER		2 PER BLISTER	
LG	-	-	RG3908015	
PB	RG3905013		RG3908013	
PR	-	-	RG3908014	
PW	RG3905011		RG3908011	
<b>RRP (€)</b>	<b>8,30</b>		<b>8,75</b>	

**LG** - Glow ; **PB** - Pearl Blue ; **PR** - Pearl Red ; **PS** - Pink Shrimp ; **PW** - Pearl White

Trade Pack: x6

## CIVELIX®

The integrated lead head allows fishing instantly without adjustment.

In fishing, the oscillation of the head of the Civelix® opposite the beats of the tail, causes an energetic serpentine movement. It focuses powerful vibratory waves that alert predators.

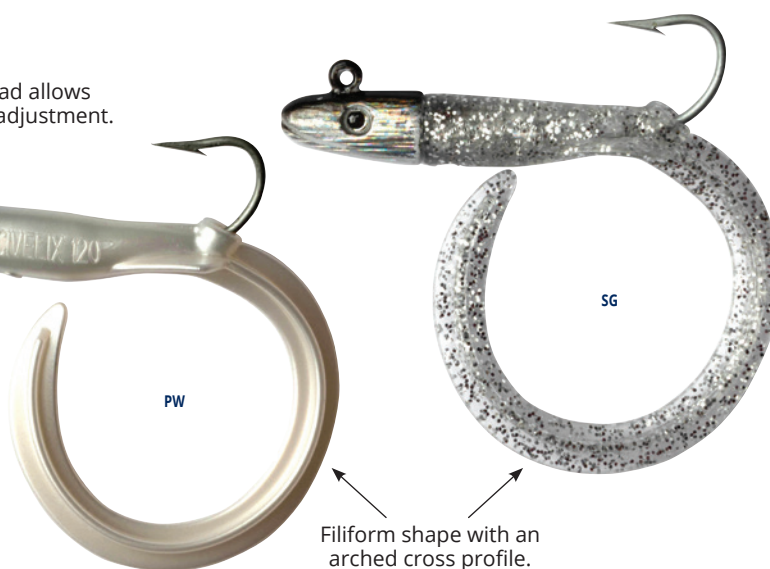

**SWIMMING ACTION**



**PW** - Pearl White ; **SG** - Silver Gold

The Civelix® is the perfect imitation of a glass eel (pibale), favorite prey of carnivores. It is very formidable to throw the edge or the boat, the zipper, the bombette or the troll.

CIVELIX®				
Color	Code	Gencod	Code	Gencod
	12 CM - 8 G		16 CM - 15 G	
	2 PER BLISTER		2 PER BLISTER	
PW	RG3930107		RG3930207	
SG	RG3930108		-	-
<b>RRP (€)</b>	<b>6,90</b>		<b>8,35</b>	

Trade Pack: x6

# LURES

## RAGTUNA



L



BT



GS



PT



RT



TBS



TBT



TOB



TSP

Ragtuna is an unique trolling lure. It has been created to catch little tunas and all pelagic in general. It can troll at many speeds up to a very fast 8/9 knot. The combo between silicon body and feathers make an irresistible attraction and no fish is able to resist it. The cut head make a turbulence on the surface and it will attract the fish from deep water. The hook is VMC Stainless Steel therefore you can catch many fish without problems. Ragtuna will be your secret lures!



RAGTUNA		
Color	Code	Gencod
7 CM - 2/0		
3 PER BLISTER		
BT	RG3921014	
GS	RG3921072	
L	RG3921074	
PT	RG3921012	
RT	RG3921016	
TBS	RG3921000	
TBT	RG3921008	
TOB	RG3921002	
TSP	RG3921004	
RRP (€)	7,40	

Trade Pack: x6

**TBS** - Transparent/Blue Sky ; **TOB** - Transparent/Ocean Blue ; **TSP** - Transparent/Shoking Pink ; **TY** - Transparent/Yellow ; **TBT** - Transparent/Blue Tiger ; **TW** - Transparent/White ; **PT** - Pink Tiger ; **BT** - Blue Tiger ; **RT** - Red Tiger ; **GT** - Green Tiger ; **GS** - Grey Smelt ; **L** - Luminous

# FISHING LINES

**NEW  
2024**

A new range of species-specific Sea rigs with Sabiki + Ragot jigs, ready rigged on nylon line. Supplied on an EVA winder for ease of use.



## MACKEREL SEABASS LINE

Code	Weight	Gencod	RRP (€)
RG4121012	50 g		<b>9,90</b>
RG4121013	85 g		<b>10,90</b>

Trade Pack: x6



## COD LINE

Code	Gencod	RRP (€)
RG4121014		<b>12,90</b>

Trade Pack: x6



## LANCON LINE

Code	Gencod	RRP (€)
RG4121015		<b>9,90</b>

Trade Pack: x6



# TROLLING LINES



Light train. Comes with a plastic box.

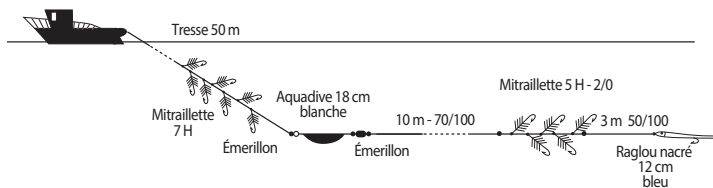

## AQUADIVE® TROLLING LINE

Code	Gencod	RRP (€)
RG4100002		41,45

Trade Pack: x1



- Presentation on wooden winder
- 50 metres of braided line
- Comes with 150g sinker
- Rigged with 4 Raglou® PB (1x105 / 2x120 / 1x140)
- Surface drag in weak currents
- Comes in blister

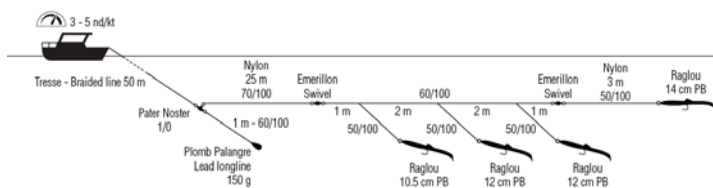

## SEMI HEAVY TROLLING LINE SEABASS

Code	Gencod	RRP (€)
RG4121004		41,45

Trade Pack: x1



- Presentation on wooden winder
- 50 metres of braided line
- Comes with 150g sinker
- Line ending with a Raglou® 120PB
- Comes with a Spare rig
- Prospecting all layers of water
- Comes in blister

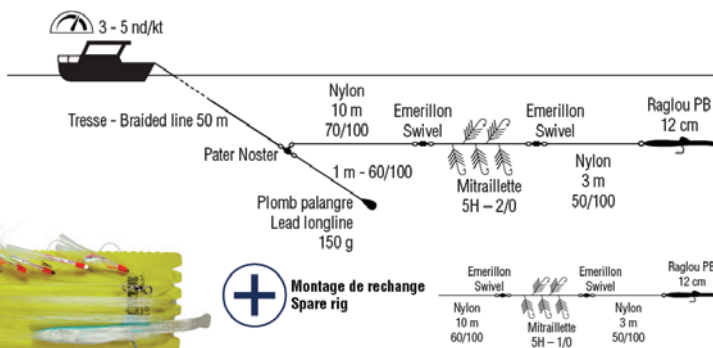

## COASTAL TROLLING LINE

Code	Gencod	RRP (€)
RG4121001		41,45

Trade Pack: x1



Comes with a plastic box.

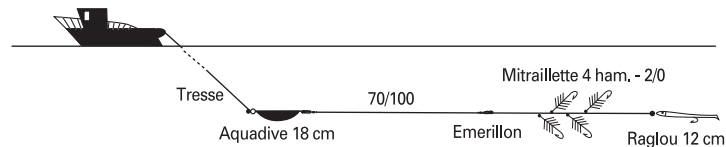

## LIGHT TROLLING LINE

Code	Gencod	RRP (€)
RG4100030		41,45

Trade Pack: x1

# TROLLING LINES

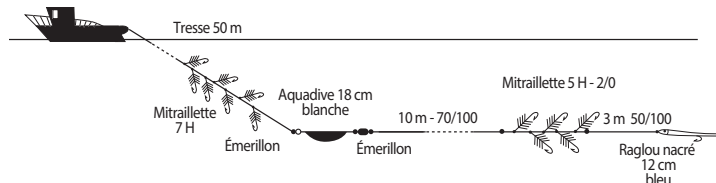

- The Aquadive® allows exploration of the deep areas without lead. Very effective at all troll speeds on bars, lures, cod, mackerel, bonito, etc... Maximum depth : 4m.
- Delivered with a pearly replacement Mitraillette®
  - Contains a spare Raglou®
  - Floating foam frame
  - Blister

## LIGHT TROLLING LINE

Code	Gencod	RRP (€)
RG4100101		41,45

Trade Pack: x1

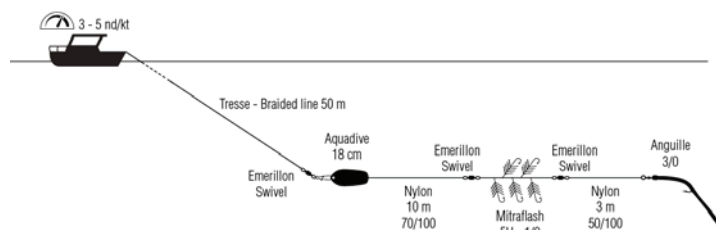

- Presentation on wooden winder
- 50 metres of braided line
- Rigged with Aquadive® 18 cm
- Line ending with a red Eel 3/0
- Surface drag in weak currents
- Comes in blister

## SHALLOW COASTAL TROLLING LINE

Code	Gencod	RRP (€)
RG4121000		41,45

Trade Pack: x1

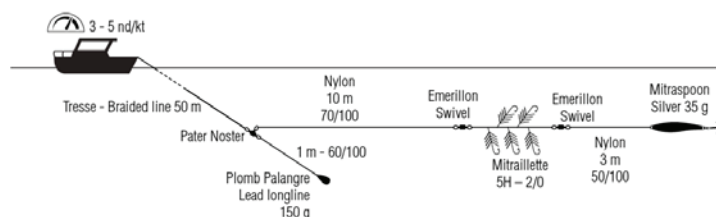

- Presentation on wooden winder
- 50 metres of braided line
- Comes with 150g sinker
- Line ending with a spoon Mitraspoon® Silver 35g
- Light trolling
- Fishing depth: 10m maximum
- Comes in blister

## SAILING TROLLING LINE

Code	Gencod	RRP (€)
RG4121005		41,45

Trade Pack: x1

# TROLLING LINES



- Presentation on EVA winder
- 25 metres of braided line
- Complete with Aquadive® 18 cm
- Line ending with a Raglou® 120PB
- Light trolling
- Comes in blister

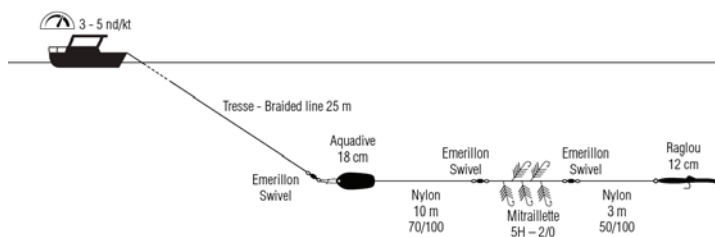

## LEISURE LIGHT TROLLING LINE

Code	Gencod	RRP (€)
RG4121006		27,15

Trade Pack: x1



- Presentation on EVA winder
- 25 metres of braided line
- Comes with 150g sinker
- Line ending with a Raglou® 120PB
- Light trolling
- Comes in blister

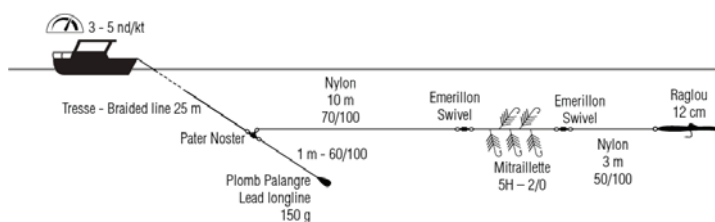

## LEISURE SAILING TROLLING LINE

Code	Gencod	RRP (€)
RG4121007		27,15

Trade Pack: x1

# LONG LINES



- Perfect for all bottom line fisheries requiring strong resistance.
- Ideal for mounting trolling lines.
- Supplied under rigid shell.

## GREEN BACKING

Code	Ø	Strength	Gencod	RRP (€)
T05035700	1 mm	30 kg / 66 Lbs		12,00
T05035900	1,80 mm	120 kg / 264 Lbs		20,80
T05039300	1,10 mm	70 kg / 145 Lbs		14,65
T05044000	2,10 mm	180 kg / 396 Lbs		29,45

Trade Pack: x1 (1 per Blister)



## LONGLINE RAPID CLIP

Code	Ø	Gencod	RRP (€)
ATO010019	1,2 x 40 mm		4,30

Trade Pack: x1 (20 per Bag)

# BAIT COLLECTION

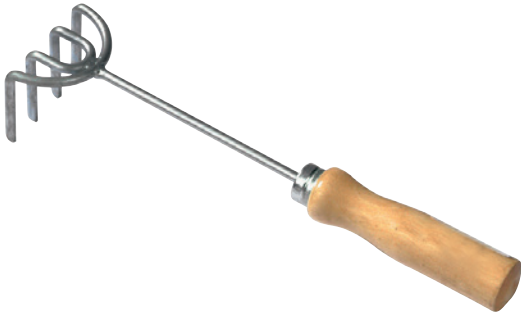

## CLAM CLAW

Code	Specifications	Material	Gencod	RRP (€)
PAP118000	28 cm 4 teeth	Galvanised metal and varnished wood		6,00

Trade Pack: x1



## CLAM CLAW

Code	Specifications	Material	Gencod	RRP (€)
PAP119000	3 teeth	Galvanised metal and varnished wood		5,55

Trade Pack: x1



## CLAM KNIFE

Code	Material	Gencod	RRP (€)
PAP127000	Galvanised metal and varnished wood		4,85

Trade Pack: x1



## OYSTER PICK

Code	Material	Gencod	RRP (€)
PAP123000	Galvanised metal and varnished wood		8,45

Trade Pack: x1



## 3 TEETH RAKE

Code	Specifications	Material	Gencod	RRP (€)
ATO700006	80 cm	Galvanised metal and varnished wood		10,85

Trade Pack: x1



## SHAVED RAKE

Code	Specifications	Material	Gencod	RRP (€)
PAP139000	100 cm	Galvanised metal and varnished wood		14,55

Trade Pack: x1



## CRAB HOOK

Code	Specifications	Material	Gencod	RRP (€)
PAP131000	80 cm	Galvanised metal and varnished wood		5,90

Trade Pack: x1



# BAIT COLLECTION



## KEEPNET FISHING ON FOOT

Code	Ø	Size	Color	Gencod	RRP (€)
ATO700002	25 cm	40 cm	Orange / Green / Yellow / Blue		11,35

Trade Pack: x1



## FISH BAG SMALL MODEL

Code	Size	Gencod	RRP (€)
ATO700011	45 x 55 cm		11,10

Trade Pack: x1



## FOOT FISHING CHILD KIT

Code	Gencod	RRP (€)
ATO700010		15,25

Trade Pack: x1

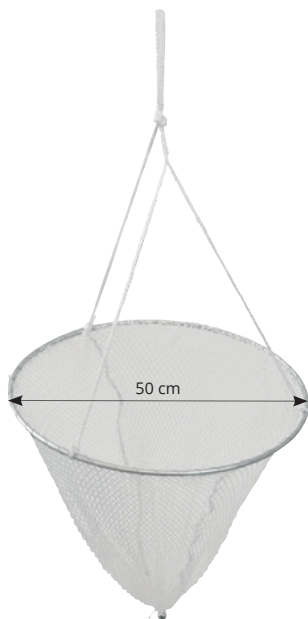

Galvanized mount. 8 mm mesh. Weighted white cotton net. Frame with sheath plastic protection

## ROUND WHITE COTTON

Code	Size	Material	Gencod	RRP (€)
AE1062706	Ø 50 cm	Galvanised metal, cotton net		17,00

Trade Pack: x1



60 cm head and 6 mm galva reinforcement. White cotton net, 10 mm mesh. 1.55 m wood handle

## GALVANISED NET

Code	Size	Gencod	RRP (€)
RG1818005	Handle : 1,55 m Head : 60 cm		38,00

Trade Pack: x1

# BAIT COLLECTION

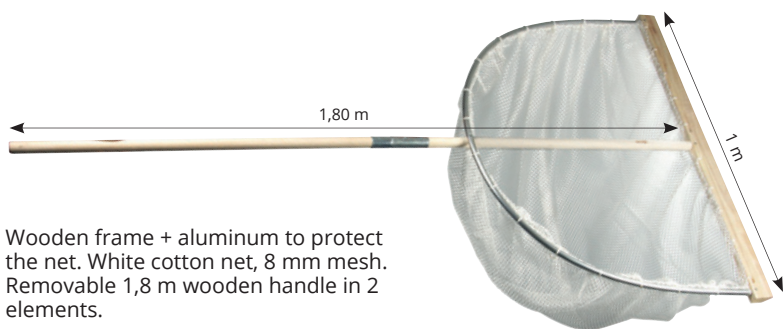

Wooden frame + aluminum to protect the net. White cotton net, 8 mm mesh. Removable 1,8 m wooden handle in 2 elements.

ALUMINIUM JOINT HANDLE				
Code	Size	Material	Gencod	RRP (€)
RG1818002	Handle : 1,8 m	Wood and aluminium, cotton net		69,20

Trade Pack: x1



Aluminum frame to protect the net. White cotton net 8 mm mesh. Varnished wood handle.

WHITE COTTON				
Code	Size	Material	Gencod	RRP (€)
AE1062709	Handle : 140 cm Head : 30 x 25 cm	Wood and aluminium, cotton net		17,80

Trade Pack: x1

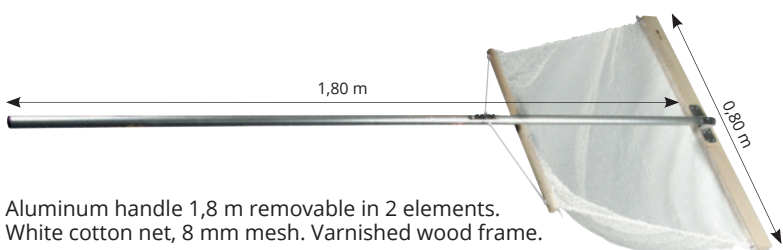

Aluminum handle 1,8 m removable in 2 elements. White cotton net, 8 mm mesh. Varnished wood frame.

FOLDING NET				
Code	Size	Material	Gencod	RRP (€)
RG1818001	Handle : 1,8 m	Wood and aluminium, cotton net		45,75

Trade Pack: x1

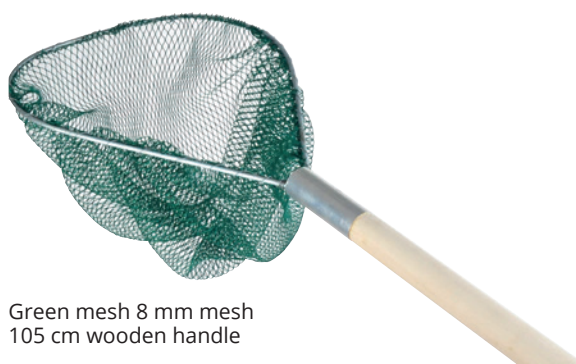

Green mesh 8 mm mesh  
105 cm wooden handle

GREEN NYLON MESH				
Code	Size	Gencod	RRP (€)	
RG1818004	Handle : 1,05 m Head : 35 x 30 cm		14,00	

Trade Pack: x1

# SEA BAITS



- Delivered with a priming bag, to fill and throw in the water in the current.
- For more efficiency, you can add 10 or 15% sardine oil.
- Suitable for fishing for shore or boat support for sea bream, mackerel, smelt or bonito.

STROUILLE 5KG		
Code	Gencod	RRP (€)
ATO750000		28,90

Trade Pack: x1



- Add 10 or 15% of sardine oil to strudel or other flour-based additives.
- Very odorous and diffuse, this oil will «boost» the effectiveness of your primer.
- Suitable for fishing for shore or boat support for sea bream, mackerel, smelt or bonito.

SARDINE OIL 1L		
Code	Gencod	RRP (€)
ATO740000		16,90

Trade Pack: x1



# INDEX

## B

BAKKAN .....	182
BANKSTICK.....	181
BRAIDS.....	174

## C

CATFISH MAT .....	182
CLONK .....	180

## D

DOUBLE SOUND BEADS.....	176
-------------------------	-----

## E

END TACKLE.....	176-177
-----------------	---------

## F

FLOATING KEEP NET.....	182
FLOATS .....	175
FLOATS - SUBSURFACE.....	175

## I

INDICATOR.....	181
----------------	-----

## J

JIG HEAD.....	180
---------------	-----

## L

LANDING NET.....	182
------------------	-----

## N

NEEDLES.....	176-177
--------------	---------

## R

REMOVABLE DELTA BOOM.....	176
RIGS .....	177
ROTATING FIRE BALL .....	180

## S

SINGLE HOOKS.....	178
SOFT BEADS.....	176
STOPPER XL .....	176
SUPER STOPPEUR .....	176
SWIVELS.....	177

## T

TREBLE HOOKS.....	179
-------------------	-----

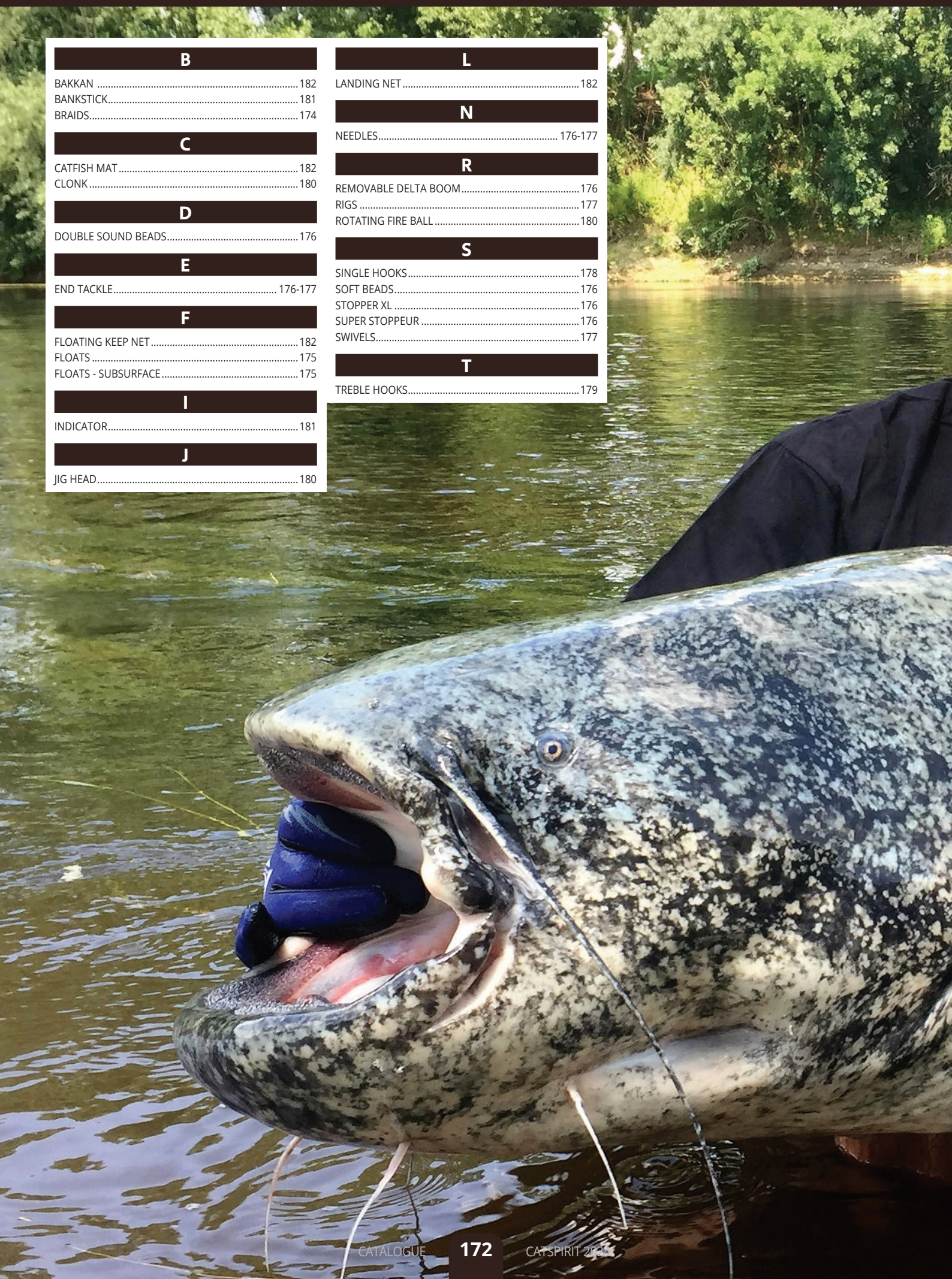





**CATSPIRIT<sup>®</sup>**





non-contractual picture

The Gyro is a hi-performance blended, braided multipurpose line made with HMPE fibers. It is a sinking line with near zero stretch ratio. It has good breaking resistance and excellent diameter to strength ratio with most commonly used knots. Can be used as mainline for casting, carp fishing, feeder fishing and boat fishing.

SUFIX GYRO					
Code	Size	Ø	Strength	Gencod	RRP (€)
060035210	250 m	0,50 mm	41,3 kg / 90 lbs		25,95
080035210	250 m	0,60 mm	56,7 kg / 125 lbs		28,95
ASU640170	1000 m	0,50 mm	41,3 kg / 90 lbs		89,95
ASU640171	1000 m	0,60 mm	56,7 kg / 125 lbs		99,95

Trade Pack: x1



Reinforced braid extremely resistant to abrasion and friction.

- Perfectly suited for the bottom of the line, but also for making dead manic frames or custom frames. (Triple mounting on lure for example).
- An essential product that must be part of your equipment because it is limitless and indispensable in the face of an opponent of size for which you must be "armed".

STRIKE CAT 20 m					
Code	Ø	Strength	Gencod	RRP (€)	
RG6000071	0,50 mm	50 kg / 110,25 lbs		9,90	
RG6000072	0,75 mm	75 kg / 165,37 lbs		10,90	
RG6000073	1 mm	100 kg / 220,50 lbs		14,65	
RG6000074	1,50 mm	150 kg / 330,75 lbs		17,45	

Trade Pack: x1



Specifically designed as a Catfish hooklink, Shock Cat provides the correct blend of high abrasion and suppleness. Available in clear, with three different breaking strain options on 20m spools.

SHOCK CAT 20 m					
Code	Ø	Strength	Gencod	RRP (€)	
RG6000005	0,80 mm	33 kg		4,90	
RG6000006	0,90 mm	38 kg		4,90	
RG6000007	1 mm	46 kg		4,90	

Trade Pack: x1

# FLOATS

**NEW  
2024**

A complete range of floats to cope with all fishing situations. Our floats are equipped with an inner silicone tube and brass eyelets for better sliding on the line to limit wear when fishing with braid.



Round float very stable and robust.  
- Brass bases for a better sliding on the line.  
- Location intended to receive a starlite of 4.5 mm.

DANUBE			
Code	Weight	Gencod	RRP (€)
RG6000012	100 g		6,90
RG6000013	200 g		8,90
RG6000014	300 g		9,90

Trade Pack: x3 (1 per bag)



Sliding float equipped with a swivel for assembly "à l'anglaise".  
- Adjust the bottom using a stop float.  
- Location intended to receive a starlite of 4.5 mm.

PO			
Code	Weight	Gencod	RRP (€)
RG6000015	250 g		13,90

Trade Pack: x3 (1 per bag)



Visibility, buoyancy and sensitivity, 3 essential qualities for our Saône float. A light body, an elongated shape and a rather low waterline gives it excellent visibility at distant fishing distances or in strong winds.  
- Its tapered shape allows it not to suffer too much resistance to penetration into the water during a shy touch.  
- Very versatile, this float is powerful in all seasons and for all situations (earthworms, live, edge, boat, drift or fixed, in strong or weak currents, ...).

SAÔNE			
Code	Weight	Gencod	RRP (€)
RG6000008	100 g		4,90
RG6000009	200 g		5,90
RG6000010	300 g		6,90
RG6000011	400 g		13,90

Trade Pack: x3 (1 per bag)

# SUBSURFACE

This range has been specially designed for subsurface float fishing, a technique still too little used because little known in France. Very easy to make, just make a 1 m bottom of the line with a hook single or triple and add the float on the leader while taking care to block it with a pearl at each end at 10 cm from the hook which will be stung in the mouth of the fish. Then connect the bottom of the line to a swivel hook and plaster to 200 g minimum. It is preferable to use medium sized live 100/250 g depending on the weight of float and current.



Underwater float noisemaker. Small balls enhance the attraction of editing under the action of the live.

RHIN			
Code	Weight	Gencod	RRP (€)
RG6000016	50 g		4,90
RG6000017	100 g		6,50

Trade Pack: x3 (1 per bag)



Underwater float available from 50 to 100g.

ODER			
Code	Weight	Gencod	RRP (€)
RG6000018	50 g		8,90
RG6000019	100 g		12,90

Trade Pack: x3 (2 per bag)

**NEW  
2024**

# END TACKLE



Flexible beads of 10 mm diameter and multi-purpose.

### SOFT BEADS

Code	Ø	Gencod	RRP (€)
RG6000035	10 mm		1,90

Trade Pack: x5 (10 per blister)



XL version of the peper that pike fishermen use to prevent the quick to release, to place on the hook to block the fish.

### STOP VIF XL

Code	Ø	Gencod	RRP (€)
RG6000039	1,50 cm		4,35

Trade Pack: x5 (20 per blister)



To achieve a fixed mounting with a lead and also very often used for assemblies with the wire broken, this rigid sliding accessory will allow to plaster the body of your line on the bottom thanks to a ballast. Its ingenious split and rotating system allows a quarter turn to easily release your line without having to cut the thread of your editing.

### REMOVABLE DELTA BOOM

Code	Gencod	RRP (€)
RG6000040		4,10

Trade Pack: x5 (2 per blister)

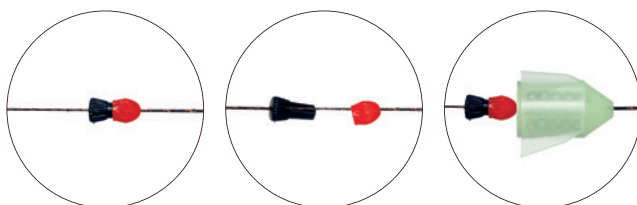

Super multi-purpose stopper to block an assembly, a float, a pearl.

### SUPER STOPPER

Code	Gencod	RRP (€)
RG6000036		3,60

Trade Pack: x5 (10 per blister)

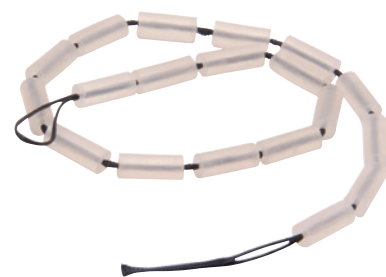

Silicone sheath with reduced inside diameter to stay in place on the nylon or braid.

- Designed to block a float or fixture.
- Put your nylon or braid in the loop and slide everything on your body line in the desired location.
- Use alone or with multiple parts for large floats or heavy fixtures.



Stop float for use with larger diameters of nylons or braids (45, 65 or 75/100 °) to adjust the depth of the float.

- Very resistant to sliding on the line.

### STOP FLOAT XXXL

Code	Color	Gencod	RRP (€)
RG6000041	Clear		1,90
RG6000042	Black		1,90

Trade Pack: x5 (10 per blister)

### SILICONE STOP

Code	Gencod	RRP (€)
RG6000043		4,50

Trade Pack: x5 (20 per blister)



Noisy capsules containing 2 steel balls that attract the attention of catfish from far away. To place on the bottom of line between the swivel and the hook.

### DOUBLE SOUND BALLS

Code	Color	Gencod	RRP (€)
RG6000037	Black		1,90
RG6000038	Phospho		1,90

Trade Pack: x5 (3 per blister)

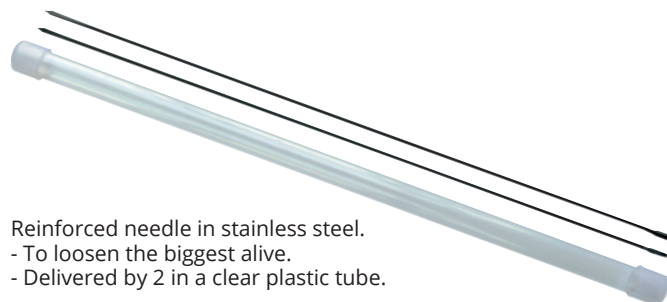

Reinforced needle in stainless steel.  
- To loosen the biggest alive.  
- Delivered by 2 in a clear plastic tube.

### REINFORCED NEEDLE

Code	Ø	Size	Gencod	RRP (€)
RG6000045	1,20 mm	25 cm		2,20

Trade Pack: x5 (2 per tube)

# END TACKLE

**NEW  
2024**



### SWIVEL CLIP

Code	Strength	Gencod	RRP (€)
RG6000046	55 kg / 121,25 lbs		3,90
RG6000047	80 kg / 176,37 lbs		4,70
RG6000048	100 kg / 220,46 lbs		5,70

Trade Pack: x3 (5 per blister)



### BALL SWIVEL WITH CLIP

Code	Strength	Gencod	RRP (€)
RG6000049	55 kg / 121,25 lbs		7,40
RG6000050	80 kg / 176,37 lbs		8,40
RG6000051	100 kg / 220,46 lbs		9,50

Trade Pack: x3 (5 per blister)



### PELLET NEEDLE

Code	Gencod	RRP (€)
RG6000044		5,20

Trade Pack: x1 (20 per blister)

## RIGS



7356BN

80 cm

6 cm

This is the classic braiding assembly. The small-sized snapper is stung directly on the hook by the nose or on the top at the dorsal fin.



### SINGLE HOOK 7356 BN RIG

Code	Size	Strength	Hameçon	Gencod	RRP (€)
RG6000052	80 cm	50 kg / 121,25 lbs	Single 7/0		3,65

Trade Pack: x3



7560BN

7356BN

120 cm

6 cm

It is the most commonly used and most effective braiding fixture for drift fishing with large size live. It allows to bite with the simple hook live under the dorsal fin. Most of the time, the triple is left free, hanging under the belly of the alive one while in other cases, some prefer to fix it on the caudal fin by means of a small elastic.



### MULTI HOOK (1 X SINGLE 7356 BN / 1 X TREBLE 7560 BN) RIG

Code	Size	Strength	Hameçon	Gencod	RRP (€)
RG6000053	120 cm	50 kg / 121,25 lbs	Treble 3/0 - Single 7/0		9,55
RG6000054	120 cm	75 kg / 176,37 lbs	Treble 4/0 - Single 9/0		10,95

Trade Pack: x3



**NEW  
2024**

# TREBLE HOOKS



Here is one of the key elements in catfish fishing: the hook. This one is subjected to hard tests, friction, wear, very important traction exerted by very powerful fishes ...

For this reason CAT SPIRIT chose to propose to you VMC hooks combining all the qualities required to face the biggest catfishes:

### REAL SIZES

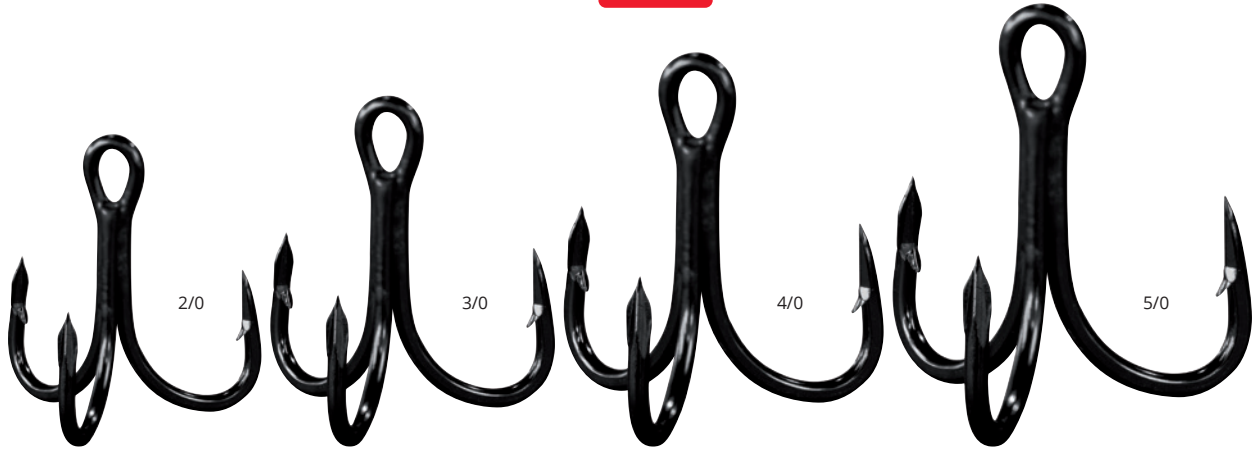

Originally designed as a model for exotic fishing, the ultra-reinforced (6X) and has been adapted for Catfishing. Extremely strong and durable construction and finished with a black Nickel coating and ultra-sharp Spark Point.

7560 BN				
Code	N°H	Quantity	Gencod	RRP (€)
RG6000026	2/0	5 per blister		16,10
RG6000027	3/0	5 per blister		16,10
RG6000028	4/0	4 per blister		16,10
RG6000029	5/0	3 per blister		16,10

Trade Pack: x3

### REAL SIZES



The 8626 is a triple hook with unparalleled versatility, reinforced (3X), just enough to cope with most fights, but not too much and therefore makes it suitable for many uses:

- change the triple hooks tired of your lures or replace others not sufficiently adapted and too fragile on fish swimmers, it is perfect to arm them properly without creating too much imbalance,
- reduces the damage to livebaits compared to a thicker gauge hook.
- delicately bunch a bunch of Canadian earthworms on a clonck mount ...It is the product that meets the requirements of our techniques in 80% of cases and the ideal tool suitable for most of our French rivers.

8626 BN				
Code	N°H	Quantity	Gencod	RRP (€)
RG6000030	1/0	5 per blister		6,50
RG6000031	2/0	5 per blister		6,50
RG6000032	3/0	5 per blister		7,50
RG6000033	4/0	5 per blister		7,50
RG6000034	5/0	5 per blister		8,50

Trade Pack: x3

# SINGLE HOOKS

**NEW  
2024**



- Extremely resistant to opening or snapping.
- PTFE coating (polytetrafluoroethylene) for faster penetration and reduced visibility.
- Ultra-sharp ground point.

8357 PTFE				
Code	N°H	Quantity	Gencod	RRP (€)
RG6000020	5/0	5 per blister		8,30
RG6000021	7/0	4 per blister		8,30
RG6000022	9/0	3 per blister		8,30

Trade Pack: x3



Originally developed for the jiggging, the 7264 VMC has an ultra-sharp ground tip, black Nickel coating, forged and reinforced opening strength. It is a simple hook, yet highly affective with super strong construction, extra wide gape and short shank making it ideal for avoiding the hook opening mid-battle. The design also provides better bait mounting :

- To hang a live through the mouth without injuring it too much and to keep it alive optimally on the frame by gluing the muzzle as close as possible to the lead
- To avoid with its short stem the tears caused by repeated movements which are amplified with a shank too long and therefore acting as a lever
- Even if it is not necessarily intended to sting the predator, its very rounded and wide shape, combined with the extreme sharpness, facilitates penetration on hesitant fish that don't get hooked on the treble
- The 7264 is also perfect for creating a hair mount for pellets or even just for fishing with natural baits

7264 BN				
Code	N°H	Quantity	Gencod	RRP (€)
RG6000023	5/0	6 per blister		5,80
RG6000024	7/0	5 per blister		5,80
RG6000025	9/0	4 per blister		5,80

Trade Pack: x3

**NEW  
2024**

# JIG HEADS



The FIRE BALL ROTATIVE CAT SPIRIT is composed of a head in which is drowned a single hook reinforced 8357 PTFE VMC.

- The space intentionally short between the lead and the tip of the hook has the main imperative to allow a clamping of the live very close to the lead, limiting the tears due to repeated animations.
- Improvement requires, rolling also partly embedded in the mass of the lead is located on the upper part and considerably limits the twisting of your line body.
- The lower eyelet in stainless steel allows to fix a stack armed with a second triple hook at the back of the live.

## ROTATING FIRE BALL

Code	Weight	N°H	Quantity	Gencod	RRP (€)
RG6000055	50 g	5/0	2 per blister		<b>6,50</b>
RG6000056	75 g	5/0	2 per blister		<b>7,50</b>
RG6000057	100 g	5/0	2 per blister		<b>7,95</b>

Trade Pack: x3 (2 per blister)

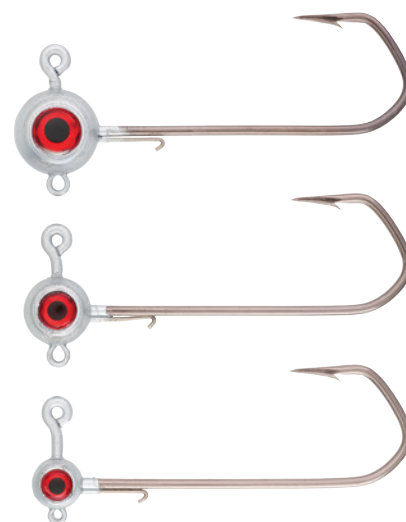

Built around a VMC Barbarian hooks size 10/0, this jig head also has second eyelet embedded underneath for the addition of a stinger. It's an indispensable product for fast fishing and crowded spots.

## JIG HEAD

Code	Weight	N°H	Quantity	Gencod	RRP (€)
RG6000058	10 g	10/0	10 per bag		<b>25,90</b>
RG6000059	20 g	10/0	10 per bag		<b>28,90</b>
RG6000060	40 g	10/0	10 per bag		<b>33,90</b>

Trade Pack: x1 (10 per bag)

# ACCESSORIES



Model to discover and learn the clonk technique.  
- Convex form.

## CLONK

Code	Gencod	RRP (€)
RG6000062		<b>7,90</b>

Trade Pack: x1



High level Bakkan made from EVA with welded seams. Designed as an all-round waterproof that will keep the contents 100% dry or as a bucket or rescue pond. Large corrosion resistant zips, hand carry handles and adjustable shoulder strap.

## BAKKAN

Code	Size	Gencod	RRP (€)
RG6000069	26 L		<b>34,90</b>

Trade Pack: x1

Reinforced steel spike (thickness of 3.25 mm) tested by our Team for a whole season during buoy fishing.

- Overflow on the top to hit with a mass to not damage the part for the rod.
- V-head for the cane, deep to avoid side ejections and covered with EVA to protect the varnish.
- Large bucket provided to receive canes with big pommel.
- Bucket adjustable over the whole length by screw and to adapt to all the rods of the market.
- Length 115 cm
- Discreet black color.

**SPECIAL SPIKE BUOY**

Code	Weight	Gencod	RRP (€)
ACT370000	1,70 kg		34,55

Trade Pack: x1



- Version without transmitter.
- Large, ultra-visible LEDs placed on the side.
- Volume adjustment.
- Significant sound power.
- Fixing clip for removable rod with screws.
- Available only in blue color.
- Works with a 9 V battery (not included).

**SHAKE 1 BLUE**

Code	Gencod	RRP (€)
RG6000066		23,90

Trade Pack: x1





**NEW  
2024**

# ACCESSORIES



The CAT SPIRIT floating net with its rubber mesh meets the requirements of retaining livebaits with minimal damage, providing a more effective bait when it comes to the time of mounting them on the rig.

- The top floating ring is intentionally disproportionate to keep the upper part of the net in place, even with a large number of bigger livebaits
- Two upper straps to secure stability and to also lift the net from the water
- Its wide opening is equipped with a cord with a quick-release system
- The fish friendly rubber net keeps your livebaits free from injury, plus does not absorb water, dries quickly and reduces any smell in your car
- The central metal ring at half height limits the compression if placed in the current
- In the lower part a ring can also have a weight attached to avoid excess movement

### FLOATING KEEP NET

Code	Size	Gencod	RRP (€)
RG6000067	55 x 90 cm		59,90

Trade Pack: x1



Purposely designed Catfish mat to protect your fish before weighing and when taking a picture. Made from rot-proof and washable fabric, that's resistant to damage from the ground. Pegging points in each corner to keep fixed in position. Always remember to add water on your mat before placing a Catfish on it. Dimensions: 300 x 200 cm.

### CATFISH MAT

Code	Size	Gencod	RRP (€)
RG6000068	300 x 200 cm		34,90

Trade Pack: x1



Practical that will make it easier for you to capture large live bait in your life bait bucket. It allows to take them live quickly without hurt them. PVC mesh to protect the fish skin.

### LANDING NET

Code	Size	Gencod	RRP (€)
RG6000070	30 x 20 x 20 cm		7,90

Trade Pack: x1



## TERMS OF SALES

**THE PRICES, WEIGHTS, DIMENSIONS OF OUR PRODUCTS, AND THE RESISTANCE OF OUR LINES ARE INDICATIVE AND NOT CONTRACTUAL. THEY CAN NOT IN ANY CASE ENGAGE ANY RAPALA VMC COMPANY.**

### PRICE

The prices in this catalogue are correct at the time of their printing and can be changed or removed at our discretion. Our prices are exclusive of tax. They are quoted per unit or per pack in euros.

### ACCOUNT OPENING

As part of the opening of a new customer account, it will be necessary to send us proof of Company registration, a bank account number and an order with a minimum value of 5.000 € + VAT or 1,000,000 HUF with payment in advance.

### DELIVERIES

Times are given as an indication, deliveries outside of these times do not entitle the buyer to cancel the order, to refuse the goods or claim damages.

### FREE CARRIAGE

FREE CARRIAGE on all orders over 100 € or 40,000 HUF, any order lower than 100 € or 40,000 HUF + VAT will incur a carriage charge of 10 € + VAT.

### PAYMENTS

A discount of 1.5% is granted for payment within eight days from the invoice date.

### LATE PENALTIES

In case of non-payment to the agreed terms, our invoices will automatically begin to accumulate interest, at a rate of 1.50% per month until settlement. In addition, a fixed cost of 40 € for administration costs will be incurred.

### CAPITALIZATION OF LATE PENALTIES

Overdue penalties still unpaid after a period of one year will accumulate interest at the national rate.

### PENALTY CLAUSE

In the case of unpaid debts, the supplier is entitled to claim from the debtor, as a penalty clause, a lump sum compensation corresponding to 10% of the total amount of the unpaid, without formal notice in advance.

### COLLECTION COSTS

Bank charges related to declined cheques will be invoiced to the debtor as well as any postage costs related to the sending of any formal notices.

### CANCELLATION CLAUSE

In case of unpaid, the sale will be resolved automatically from the notice sent to the debtor.

### TERMINATION CLAUSE OF THE TERM

Failure to pay a single payment will result in the immediate payment of all our receivables and the suspension of deliveries.

### TITLE RETENTION CLAUSE

The supplied goods will remain our property until the full payment is received, this will allow us to recover them in case of unpaid.

### RISK TRANSFER CLAUSE

Despite the existence of a retention of title clause on our goods, the buyer will bear all the risks as from the receipt of these. As a result, he must have an insurance contract in place prior to the receipt of the goods.

### APPLICATIONS OF THE LEGAL GUARANTEE

The guarantee applied will be the legal guarantee at the time of the transaction, in all cases, we will not accept any repair or exchange of products under warranty unless the receipt or the duly completed and dated guarantee form is attached.

### CLAIMS AND RETURNS CLAIM

Regarding disputes arising during transport, the onus is on the addressee to raise any discrepancies and necessary reservations specifying the nature of the issues, loss, missing, damage or delay. Claims concerning the quality of the goods must be made within 48 hours with the company.

### RETURN OF GOODS

All returns of goods must be subject to prior authorization from your local Rapala VMC Distributor or any other Rapala VMC affiliates. Products must be returned in their original packaging, untagged and undamaged. Rapala VMC companies reserves the right to apply a discount on returned products (a minimum of 30%).

### ATTRIBUTIVE CLAUSE OF COMPETENCE

In the event of litigation, both with our suppliers and with our clients, the attribution of competence is made to the courts from our head office.

### BRANDS AND LOGOS

The use of our trademarks, logos and images of our products is subject to authorization.





**Rapala VMC France**  
ZI - 49, rue de l'Industrie  
90140 BOUROGNE  
+33(0)3 84 57 35 00  
[contact-normark@rapala.fr](mailto:contact-normark@rapala.fr)

