



SOME OF OUR NEW PRODUCTS FOR 2025



**CAMO
RANGE**



**BLAX
EVO RODS**

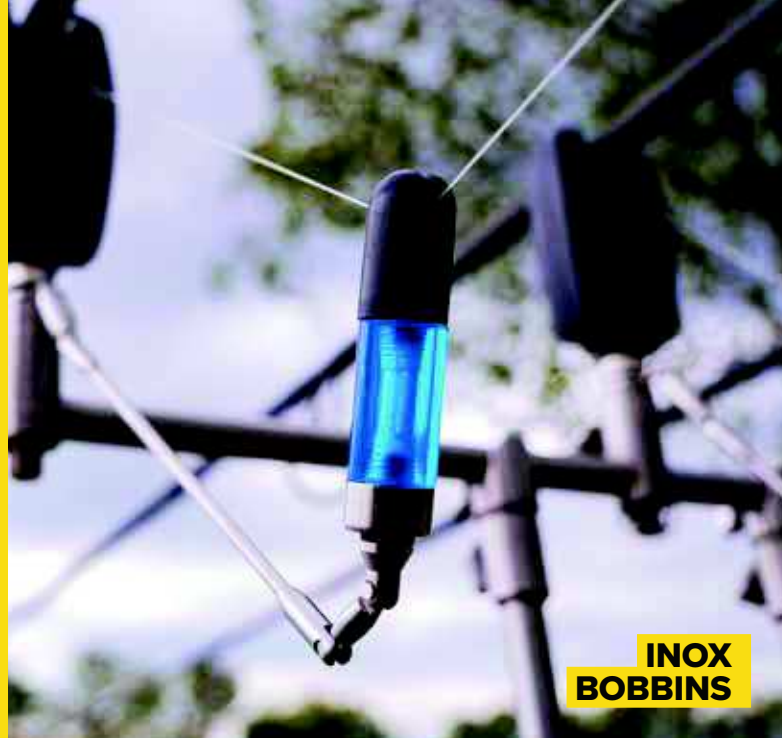

**INOX
BOBBINS**



**DISTANCE
IN-LINE CAMO**



**MAGNUM XL LONG DISTANCE
THROWING STICK**



**NEOPRENE
BOOTS**



**BLAX BED
8 EVO**

INDEX

A		G		R	
A.L.S MARKER	925	GOLIATH	811	RAZORBACK BROLLY	791
ALARMS	795 to 804	GRAVITY™ LEADCORE	884	RAZORLITE BIVVY	787
ANTI-TANGLE	903			READY RIGS	872 to 876
B		H		ROD END PROTECTOR	
BAGS	761 - 776 to 779	HAMMER	794	ROD HOLDALLS	761 & 772 to 775
BACK LEAD	910	HANGERS	808	ROD POD	810 to 814
BACK LEAD CLIPS	910	HD3	800	ROD REST	822 to 823
BAIT BAND	900	HD4	799	ROD SLEEVE	761 - 774
BAIT CRUSHER	926	HD5	798	ROD SUPPORTS	822 to 823
BAIT FLOSS™	891	HOODIES	929	RODS	825 to 835
BAIT GUN	926	HOOKLINKS	885 to 888	ROUND RINGS	906
BAIT GUN NOZZLE	926	HOOKS	868 to 871		
BAKKAN	779	HYDRO BAG	778	S	
BANK STICK	817	HYDRO BOX	778	SCALE TRIPOD	849
BARROW	780			SCALES	849 - 850
BED CHAIR TABLE	749	I		SCOOP	921
BEDS	747 to 748 - 759	INDICATORS	795 to 804	SCS+	792
BITE ALARMS	795 to 804	IN-LINE LEAD	907	SEAT	750 to 757 & 759 to 760
BIVVIES	781 - 792	INOX BANK STICK	817	SET OF 4 POP-UP/DIP POTS	924
BIVVY TABLE	793	INOX ROD POD	810	SHELTERS	786 to 787 & 790 to 792
BLACK BOAT	851 to 861	J		SHOCKLEADERS	882 to 883
BLAX 2 MAN - 1 MAN	788	JOGGERS	930	SHOVEL	921
BLAX ALARM	802 - 803	K		SHOWER	794
BLAX ROD POD	811 to 813	KEY	819	SHRINK TUBE	899
BLAX EVO RODS	834 - 835	CRIMPS	888	SINKERS	907 to 910
BLUE ALARM	804	L		SLEEPING BAGS	763 to 769
BOAT ACCESSORIES	862 to 865	LANDING NET FLOAT	842	SLEEVES	888
BOAT PUMP	862	LANDING NETS	837 to 842	SNAG EARS	805
BOATS	851 to 861	LEAD CLIP TAIL RUBBERS	896	SNAPS	906
BOILIE GUARD	916	LEAD CLIPS	896	SOLURON	911 to 914
BOILIE ROLLING TABLE	925	LEAD CORE	884	SPEED-R	790
BOILIE STOP	892 - 893 - 902	LEADS	907 to 910	SPOD & MARKER BRAID™	881
BOOTS	932	LEVEL CHAIR	750 to 757 & 759 to 760	SPOOLS CASE	779
BOX	927	LIFE FISH BAG	846	SPRING	903
BRAIDED MAINLINE	881	LINE REMOVER	879	STORAGE FLOATING BAG	846
BUCKET	922 to 924	LOCKING BUTT GRIP	822	STORM POLES	817
BUCKET STAND	922 - 923	LUGGAGE	771 to 780	STRIP-EAZE TOOL	894
BUZZ BAR	818 - 820	M		SUNGLASSES	931
C		MAGGOT CLIP	899	SWIVELS	904 to 907
CAMPING SET	780	MAGNUM 100	786	T	
CAP	931	MAGNUM ROD X2	832 - 833	TABLE	749 - 793
CARRYALLS	761 - 776	MAGNUM ROD X3	830	TACKLE BOXES	927
CASTING GLOVE	882	MAGNUM ROD X5	829	TENTS	781 - 792
CATAPULT	919	MAGNUM ROD XLR	828	TERMINAL TACKLE	895 to 903
CELT-2X™	878	MARKERS	925	THROWING STICK	918 - 919
CHAIRS	750 to 757 & 759 to 760	MAT	844 - 848	TOOLS	889 to 894
CLOTHING	929 to 930	METALLIC LEAD CLIPS	896	TRIPOD BUCKET STAND	922 - 923
CORD	862	METHOD FEEDER	910	TROLLEY	780
CRADLES	845	MONOFILAMENT MAINLINE	878 to 880	T-SHIRTS	929
D		MOON CHAIR	754 - 760	TUBING	898 - 899
DISTANCE STICK	920	M-TX™	880	TUNGSTEN	898 - 899
DOLMEN	784	N		TUNGSTEN PUTTY	899
DRESSEN-X™	882	NEEDLE	890 - 891 - 902	U	
DIGITAL SCALE	849	NET PROTECTION	841	UNHOOKING MATS	844 - 848
DRILL	891	NYLONS	878 to 880	V	
D-RIG POP-UP PIN	901	O		VELOCITY™ XS	878
E		OUT HOUSE	789	W	
EVEREST	785	P		WADERS	933
F		PILLOW	770	WATER SCANNER	866
FEATURE FINDING LEAD	910	PLIERS	888	WEIGHT SLING BAG	847
FLOATING BAG	846	POP-UP PEGS	901		
FLOATING BAIT	892	PRODDING STICK	866		
FOLDABLE BUCKET	924	PVA	911 to 914		
		PVA BAGS	913		
		PVA LOADER	914		

BEDS & CHAIRS

CARPSPIRIT | BEDS & CHAIRS



SPRING LOCK SYSTEM



The Spring Lock System allows a simple and quick adjustment of the leg lengths to the respective conditions of the bottom structure with just one hand. Through a spring mechanism, the leg length jumps to the desired height. By letting go of the adjustment, the leg is locked in the desired place. This is very easy and comfortable, especially in hard-to-reach places, such as the inner back of the tent wall.

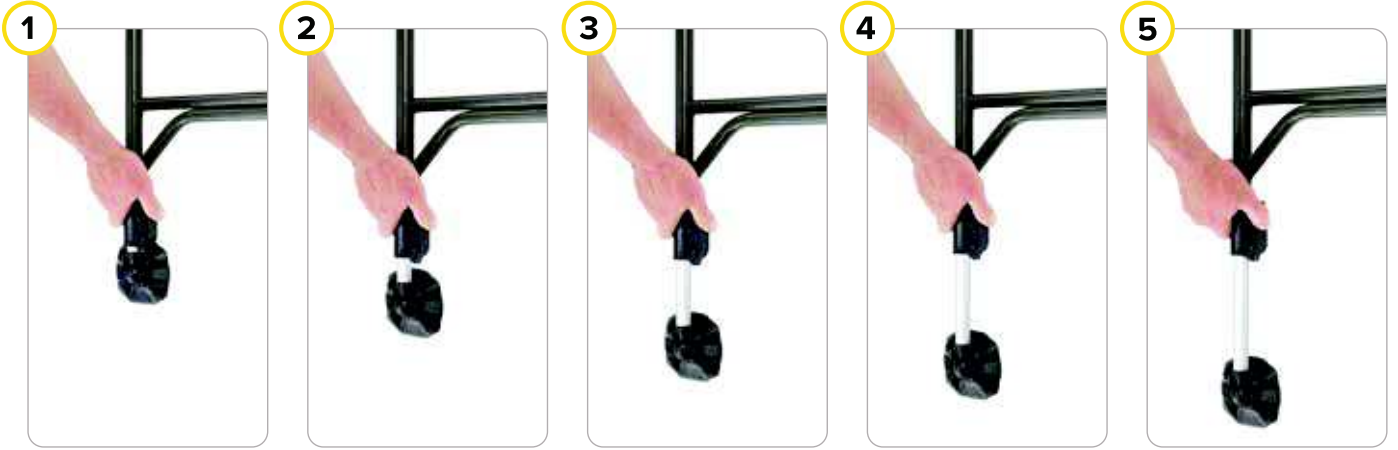

BEDS

MAGNUM BED XL-8 LEG EVO

BLAX BED 8 EVO

BED CHAIR 6 LEGS

NEW 2025



747



NEW 2025



748



748

Product Code	ACS520061	ACS520062	147500360
Key USP	ULTIMATE COMFORT	OUTSTANDING VALUE	THE BEST VALUE FOR MONEY
Frame Material	Aluminium	Steel	Steel
Leg Material	Steel	Steel	Steel
Powder Coated Frame	●	●	—
Number of Adjustable Legs	8	8	6
Self Inflating Air Mattress	—	—	—
Neoprene Pillow	●	●	●
Fold Flat In-Line Frame	●	●	—
Safety Clips	●	●	●
Dimensions (L/W/H)	220 x 105 x 37-47 cm	216 x 101 x 37-47 cm	201 x 74 x 31-45 cm
Weight	13.25kg	12.7kg	9.8kg
Maximum Load Rating	200kg	150kg	125kg
Recommended Sleeping Bag Size	SIZE XL	SIZE XL	SIZE STANDARD

MAGNUM BED XL-8 LEG EVO NEW 2025

- A feature packed bed that meets the needs of the most dedicated angler.
- Built on a lightweight fold flat Aluminium frame, and incorporating a hollow fibre filled central mattress, the Magnum Bed is highly durable and offers excellent thermal efficiency and comfort.
- Fully adjustable legs with auto lock adjustment to combat the most unaccommodating of bankside locations.

Perfect size for use with all our XL size sleeping bags (see pages 766 to 768).



THE DETAIL

- 1 Hollow fibre filled mattress.
- 2 Low-Profile neoprene pillow.
- 3 Lightweight Aluminium fold flat frame.
- 4 CamoSkin™ perimeter.
- 5 Side carry handles.
- 6 Fully adjustable legs with auto lock adjustment.
- 7 360° articulated mud-feet.

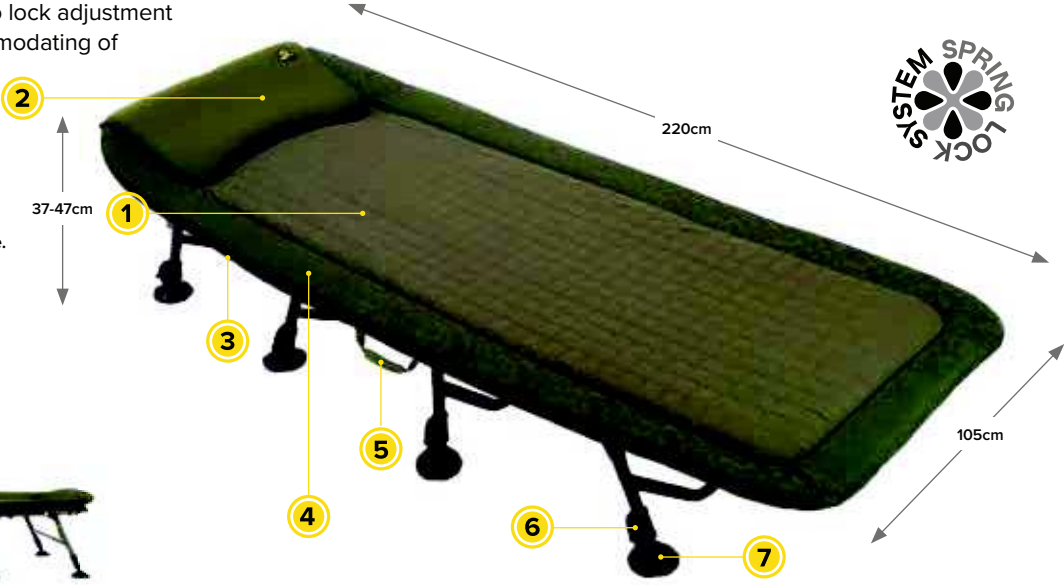

CODE	SIZE (CM)	WEIGHT (KG)	MAX LOAD (KG)	GENCOD	TRADE PACK	RRP (€)
MAGNUM BED XL-8 LEG EVO						
ACS520061	220 x 105 x 37-47	13.25	200		1	299.99

BLAX BED 8 EVO NEW 2025

- Bed that offers exceptional performance and value.
- The high-density foam filled mattress and fold flat steel frame, results in a highly durable bed that provides a fantastic night's comfort.
- All legs are fully adjustable to combat the most unaccommodating of bankside locations.

Perfect size for use with all our XL size sleeping bags (see pages 766 to 768).



THE DETAIL

- ① High density foam filled mattress and perimeter.
- ② Low-profile neoprene pillow.
- ③ Fold flat steel frame.
- ④ Fully adjustable legs with auto lock adjustment.
- ⑤ x8 swivelling mud-feet.



CODE	SIZE (CM)	WEIGHT (KG)	MAX LOAD (KG)	GENCOD	TRADE PACK	RRP (€)
BLAX BED 8 EVO						
ACS520062	216 x 101 x 37-47	12.7	150		1	209.99

CARPSPIRIT BED CHAIR 6 LEGS

- 6 telescopic legs.
- Large feet.
- Safety clips.
- Steel framework.
- Quilted fabric (500D).
- Built-in mud protector.
- Maximum load 125kg.

Perfect size for use with all our standard size sleeping bags (see page 769).





CODE	SIZE (CM)	WEIGHT (KG)	MAX LOAD (KG)	GENCOD	TRADE PACK	RRP (€)
BED CHAIR 6 LEGS						
147500360	201 x 74 x 31-45	9.8	125		1	119.99

BLAX BED CHAIR TABLE

- Lightweight table that is compatible with 22mm profile beds and chairs.
- Perfect storage area for all accessories you need to hand.



CODE	SIZE (CM)	WEIGHT (KG)	MAX LOAD (KG)	GENCOD	TRADE PACK	RRP (€)
BED CHAIR TABLE						
374001361	40 x 18	0.52	–		1	29.99



CHAIRS

MAGNUM DELUXE CHAIR EVO

NEW 2025



752

MAGNUM HI-BACK CHAIR EVO

NEW 2025



752

Product Code	ACS520064	ACS520065
Key USP	OUR ULTIMATE CHAIR – OPTIMUM COMFORT	
Frame Material	Aluminium	Aluminium
Leg Material	Aluminium	Aluminium
Powder Coated Frame	●	●
Number of Adjustable Legs	4	4
Neoprene Headrest	●	●
Adjustable Backrest	●	●
Dimensions	Back Rest (L): 70cm Seat (W): 52cm Seat (H): 38-51cm	Back Rest (L): 70cm Seat (W): 55cm Seat (H): 38-51cm
Weight	6.9kg	6.4kg
Maximum Load Rating	160kg	140kg

CHAIRS

COMFORT CHAIR

NEW 2025



755

LEVEL CHAIR PADDED WITH ARMS



756

Product Code	ACS520056	ACC520008
Key USP		
Frame Material	Steel	Steel
Leg Material	Steel	Steel
Powder Coated Frame	●	—
Number of Adjustable Legs	4	4
Neoprene Headrest	—	—
Adjustable Backrest	—	●
Dimensions	Back Rest (L): 55cm Seat (W): 55cm Seat (H): 47cm	Back Rest (L): 66cm Seat (W): 49cm Seat (H): 30-37cm
Weight	5.5kg	6.5kg
Maximum Load Rating	150kg	100kg

BLAX RELAX CHAIR XL



754

ACS520054

BLAX RELAX CHAIR L



754

ACS520049

BLAX MOON CHAIR



754

ACS520050

BLAX MOON CHAIR SMALL



754

ACS520066

LONG SESSION CHAIR AT A GREAT PRICE

A CHAIR BY THE WATER

Steel	Steel	Steel	Steel
Steel	Steel	Steel	Steel
●	●	●	●
4	4	—	—
●	●	●	●
●	●	●	●
Back Rest (L): 65cm Seat (W): 53cm Seat (H): 50-60cm	Back Rest (L): 65cm Seat (W): 49cm Seat (H): 41-51cm	Diameter: 100cm	Diameter: 82cm
6.15kg	5.75kg	7kg	4.95kg
130kg	130kg	120kg	120kg

LEVEL CHAIR WITH ARMS



756

ACC520009

LEVEL CHAIR



757

ACC520010

LEVEL CHAIR LIGHT



757

ACS520057

Steel	Steel	Steel
Steel	Steel	Steel
—	—	—
4	4	4
—	—	—
—	—	—
Back Rest (L): 52cm Seat (W): 49cm Seat (H): 41-50cm	Back Rest (L): 52cm Seat (W): 48cm Seat (H): 31-39cm	Back Rest (L): 45cm Seat (W): 46cm Seat (H): 25-31cm
5.5kg	4.0kg	3kg
100kg	100kg	100kg

MAGNUM DELUXE CHAIR EVO

NEW 2025

- Sets the standard for bankside comfort.
- Featuring a fully adjustable back rake system, neoprene padded arms and head rest, and a thermoformed anti-slip mattress, this fully adjustable chair is the perfect solution for anglers looking for luxury on any terrain.

THE DETAIL

- 1 Neoprene padded upper mattress.
- 2 Fully adjustable back rake system.
- 3 Neoprene padded armrest.
- 4 CamoSkin™ perimeter with high density foam padding.
- 5 Lightweight Aluminium frame.
- 6 Non reflective powder coated frame.
- 7 Fully adjustable legs with auto lock adjustment.
- 8 4x 360° articulated mud-feet.

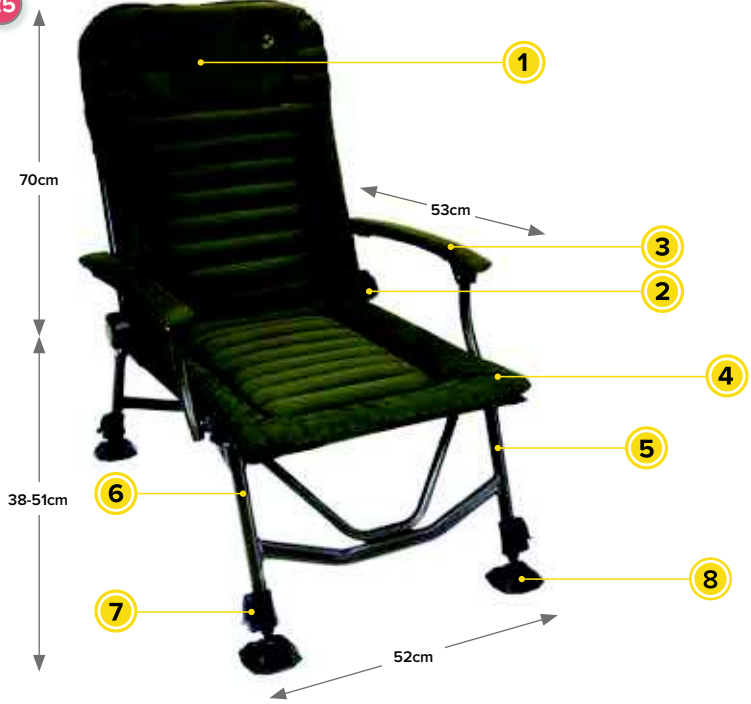

CODE	WEIGHT (KG)	MAX LOAD (KG)	GENCOD	TRADE PACK	RRP (€)
MAGNUM DELUXE CHAIR EVO					
ACS520064	6.4	140		1	194.99

MAGNUM HI-BACK CHAIR EVO

NEW 2025

- Hi-back style chair that offers fantastic comfort and lumbar support.
- Featuring multi angle position locks and full leg adjustment, this chair is perfect for the most demanding of bank side settings.

THE DETAIL

- 1 Hi-back support with multi angle position lock.
- 2 Neoprene padded upper mattress.
- 3 High density foam.
- 4 Hi-impact moulded ergonomic arms rests.
- 5 CamoSkin™ perimeter.
- 6 Aluminium / steel frame.
- 7 4x fully adjustable legs with auto lock adjustment.
- 8 4x 360° articulated mud-feet.

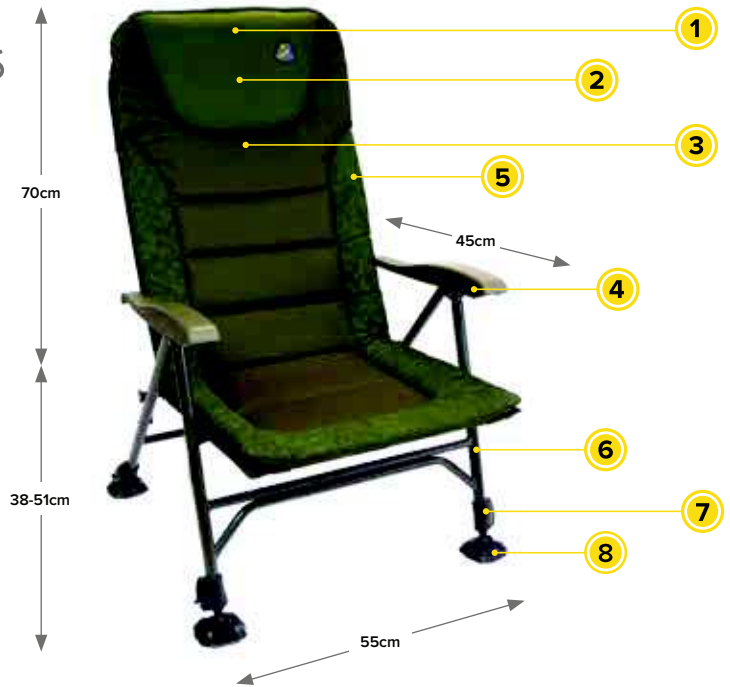

CODE	WEIGHT (KG)	MAX LOAD (KG)	GENCOD	TRADE PACK	RRP (€)
MAGNUM HI-BACK CHAIR EVO					
ACS520065	6.9	130		1	119.99



BLAX RELAX CHAIR

- Two fantastic value hi-back chairs.
- Manufactured using high-grade steel frames.
- Featuring a reclining back mechanism.
- Armrests.
- Four fully adjustable legs and mudfeet.
- Finished with a fully padded mattress, perimeter and headrest.



CODE	WEIGHT (KG)	MAX LOAD (KG)	GENCOD	TRADE PACK	RRP (€)
BLAX RELAX CHAIR					
ACS520054 (XL)	6.15	130		1	116.99
ACS520049 (L)	5.75	130		1	96.99

BLAX MOON CHAIR

- Rounded shape chair offering maximum comfort.
- Just like your favourite sofa, but for the water's edge.
- Fully padded mattress.
- High-grade steel frame.
- Foldable version enabling easy transportation & storage.
- Supplied with a carry bag.
- Maximum load rating: 120kg.



CODE	DIAMETER (CM)	WEIGHT (KG)	MAX LOAD (KG)	GENCOD	TRADE PACK	RRP (€)
BLAX MOON CHAIR						
ACS520050	100	7.0	120		2	97.99
ACS520066 (S)	82	4.95	120		2	82.99

NEW 2025

CARPSPIRIT COMFORT CHAIR

NEW 2025

- An extremely comfortable padded folding chair with armrests, made from 600D Oxford Nylon and a super strong steel.
- Suitable for many types of fishing and outdoor use.
- Supplied with a carry case for easy transportation.
- Max Loading weight: 150 kg.



CARPSPIRIT
BEDS &
CHAIRS

CODE	WEIGHT (KG)	MAX LOAD (KG)	GENCOD	TRADE PACK	RRP (€)
COMFORT CHAIR					
ACS520056	5.5	150		1	82.99



CEDRIC LEVET 
 @French_Carp_Angler

CARPSPIRIT LEVEL CHAIR PADDED WITH ARMS

- Premium range chair.
- Steel framework.
- 4 telescopic feet.
- Big feet.
- Safety clips
- Quilted fabric 500D with large edges.
- Maximum load 100kg.



CODE	WEIGHT (KG)	MAX LOAD (KG)	GENCOD	TRADE PACK	RRP (€)
LEVEL CHAIR PADDED WITH ARMS					
ACC520008	6.5	100		1	88.99

CARPSPIRIT LEVEL CHAIR WITH ARMS

- Level chair with armrest.
- Steel framework.
- 4 telescopic legs.
- Large feet.
- Safety clips.
- Quilted fabric (500D).
- Maximum load 100kg.



CODE	WEIGHT (KG)	MAX LOAD (KG)	GENCOD	TRADE PACK	RRP (€)
LEVEL CHAIR WITH ARMS					
ACC520009	5.5	100		1	65.99

CARPSPIRIT LEVEL CHAIR

- Steel framework.
- 4 telescopic legs.
- Large feet.
- Safety clips.
- Quilted fabric (500D).
- Maximum load 100kg.



CODE	WEIGHT (KG)	MAX LOAD (KG)	GENCOD	TRADE PACK	RRP (€)
LEVEL CHAIR					
ACC520010	4.0	100		1	53.99

CARPSPIRIT LEVEL CHAIR LIGHT

NEW 2025

- Steel frame.
- 4 telescopic legs.
- Adjustable feet with clips.
- 2 safety clips.
- Maximum load 100kg.



CODE	WEIGHT (KG)	MAX LOAD (KG)	GENCOD	TRADE PACK	RRP (€)
LEVEL CHAIR LIGHT					
ACS520057	3.0	100		1	36.99

CAMO RANGE



BLAX CAMO BED 8 CAMO

NEW 2025

- Bed that offers exceptional performance and value.
- The high-density foam filled mattress and fold flat steel frame, results in a highly durable bed that provides a fantastic night's comfort.
- All legs are fully adjustable to combat the most unaccommodating of bankside locations.

THE DETAIL

- 1 High density foam filled mattress and perimeter.
- 2 Low-profile neoprene pillow.
- 3 Fold flat steel frame.
- 4 Fully adjustable legs with auto lock adjustment.
- 5 x8 swivelling mud-feet.



Perfect size for use with all our XL size sleeping bags (see pages 766 to 768).



CODE	SIZE (CM)	WEIGHT (KG)	MAX LOAD (KG)	GENCOD	TRADE PACK	RRP (€)
BLAX BED 8 CAMO						
ACS520067	216 x 101 x 37-47	12.7	150		1	214.99

MAGNUM CAMO HI BACK CHAIR

NEW 2025

- Hi-back style chair that offers fantastic comfort and lumbar support.
- Featuring multi angle position locks and full leg adjustment, this chair is perfect for the most demanding of bank side settings.

THE DETAIL

- 1 Hi-back support with multi angle position lock.
- 2 Neoprene padded upper mattress.
- 3 High density foam.
- 4 Hi-impact moulded ergonomic arms rests.
- 5 Aluminium / steel frame.
- 6 4x fully adjustable legs with auto lock adjustment.
- 7 4x 360° articulated mud-feet.



CODE	WEIGHT (KG)	MAX LOAD (KG)	GENCOD	TRADE PACK	RRP (€)
MAGNUM HI BACK CHAIR CAMO					
ACS520068	6.4	140		1	122.99

BLAX CAMO RELAX CHAIR XL NEW 2025

- Fantastic value hi-back chair.
- Manufactured using high-grade steel frames.
- Featuring a reclining back mechanism.
- Armrests.
- Four fully adjustable legs and mudfeet.
- Finished with a fully padded mattress, perimeter and headrest.



CODE	WEIGHT (KG)	MAX LOAD (KG)	GENCOD	TRADE PACK	RRP (€)
BLAX RELAX CHAIR XL CAMO					
ACS520069	6.15	130		1	119.99

BLAX CAMO MOON CHAIR NEW 2025

- Rounded shape chair offering maximum comfort.
- Just like your favourite sofa, but for the water's edge.
- Fully padded mattress.
- High-grade steel frame.
- Foldable version enabling easy transportation & storage.
- Supplied with a carry bag.
- Maximum load rating: 120kg.



CODE	SIZE (CM)	WEIGHT (KG)	MAX LOAD (KG)	GENCOD	TRADE PACK	RRP (€)
BLAX MOON CHAIR CAMO						
ACS520070	100	7.0	120		2	104.99

BLAX CAMO **ROD SLEEVE** **NEW 2025**

- Individual rod sleeve with central partition.
- EVA carry handle.
- Access zip located on the opposite side of reel to prevent catching and damage to mainline or braid.



CARP SPIRIT
CAMO
RANGE

CODE	RODS (FT)	WEIGHT (KG)	GENCOD	TRADE PACK	RRP (€)
BLAX ROD SLEEVE CAMO					
ACS070092	12	0.90		1	33.99
ACS070093	10	0.76		1	31.99

BLAX CAMO **CARRYALL MEDIUM** **NEW 2025**

- Multi-compartment carryall, perfect for short and medium sessions. Manufactured from high-quality material, complete with easy access external pockets, hand carry handles and an adjustable shoulder strap.



CODE	SIZE (CM)	WEIGHT (KG)	GENCOD	TRADE PACK	RRP (€)
BLAX CARRYALL MEDIUM CAMO					
ACS070094	58 x 32 x 32	1.5		1	74.99

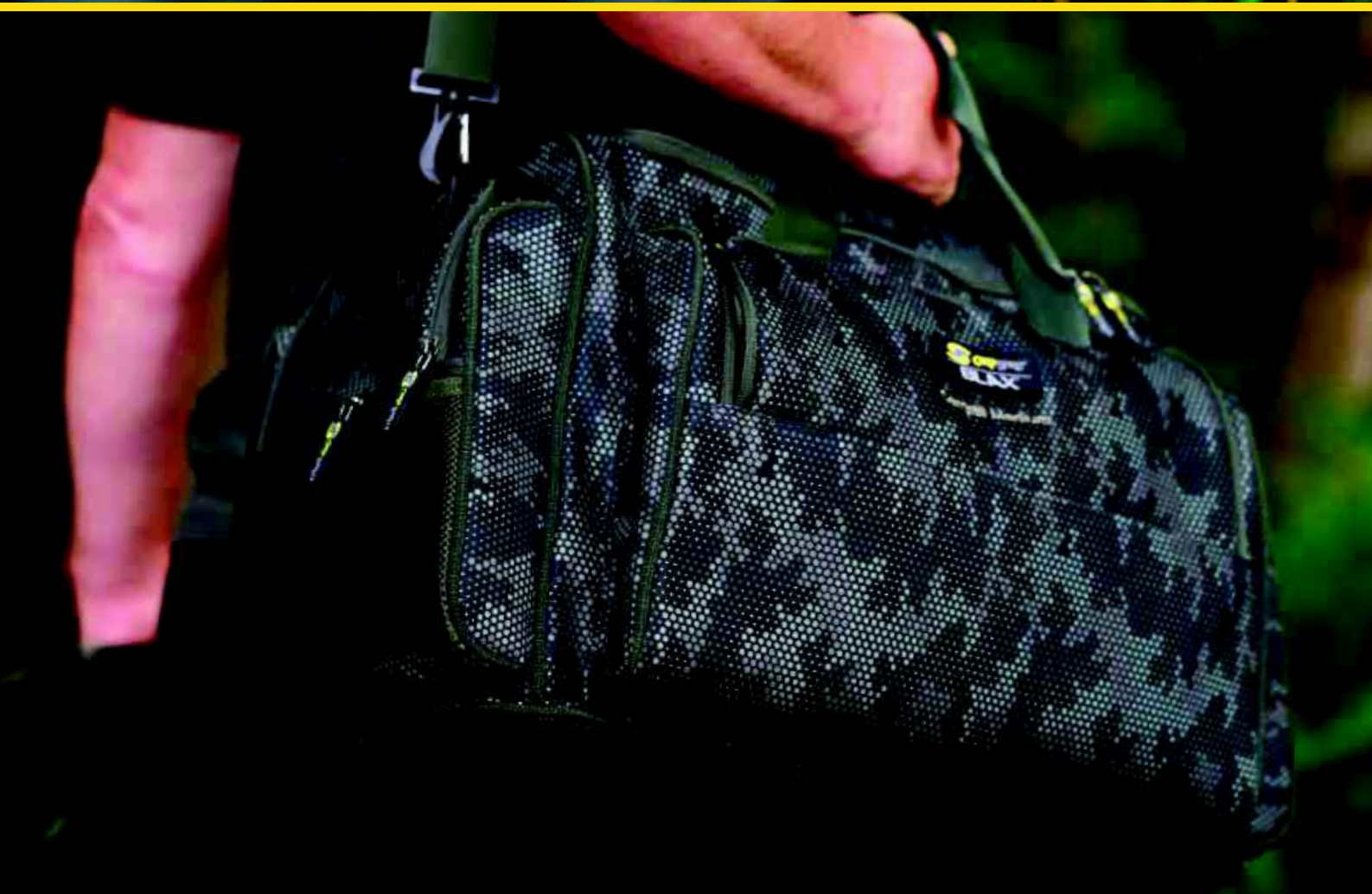

SLEEPING BAGS & ACCESSORIES



SLEEPING BAGS

Being comfortable on the bank is a must – the more comfortable you are, the better you’ll fish... and this will ultimately contribute to your success rate. Here at Carp Spirit we take bankside comfort very seriously, so when we developed a complete new range of Magnum and BLAX sleeping bags and covers, there was a huge focus on research, development and testing to ensure that the finished range of products are the very best available on the market, yet still offer excellent value for money. Rather than just develop a new range of sleeping bags in isolation, we actually designed them as a parallel development alongside the all new Magnum and BLAX beds. The end result is a superb synergy between both our sleeping bags and beds that uses a simple two sizing system;

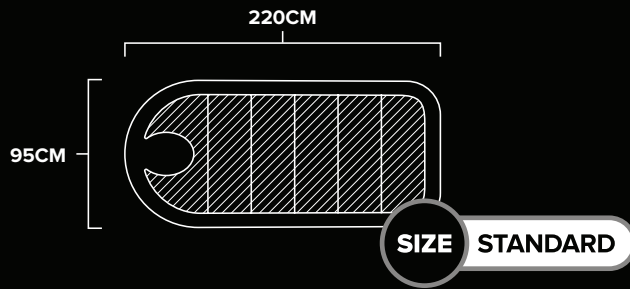
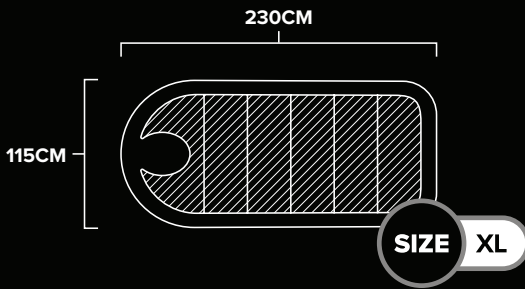

So whether you’re fishing summer nights under a brolly, or a winter session in sub-zero temperatures, you can be sure that there’s a Carp Spirit sleeping bag with the performance to meet your requirements, keeping you comfortable and warm during your session.

MAGNUM 4 SEASON SLEEPING BAG XL



767

MAGNUM 4 SEASON SLEEPING BAG STD



767

Product Code	ACS520042	ACS520043
Key USP	FANTASTIC ALL SEASON SLEEPING BAG	
Min Temp Rating	-10°	-10°
Filling	Silicon Treated 4 Season Hollow Fibre	Silicon Treated 4 Season Hollow Fibre
Outer	Waterproof Rip Stop Polyester	Waterproof Rip Stop Polyester
Inner	Micro Fleece Upper – Polyester Lower	Micro Fleece Upper – Polyester Lower
Detachable Centre Layer	—	—
Oval Face Cut Out	●	●
10mm Heavy Duty Crash Zips	●	●
Internal & External Zip Baffles	●	●
3 Point Bed Attachment	●	●
Compression Stuff Sack	●	●
Thermal Foot Pocket	●	●
Pillow Retention Draw Cord	●	●
Mesh Side Storage Pockets	●	●
Sleeping Bag Size	SIZE XL	SIZE STANDARD

MAGNUM 5 SEASON SLEEPING BAG XL

MAGNUM 5 SEASON SLEEPING BAG STD

766



766



Product Code	ACS520040	ACS520041
Key USP	THE ULTIMATE IN COMFORT, WARMTH AND FLEXIBILITY	
Min Temp Rating	-20°	-20°
Filling	Silicon Treated 5 Season Hollow Fibre	Silicon Treated 5 Season Hollow Fibre
Outer	Waterproof Rip Stop Polyester	Waterproof Rip Stop Polyester
Inner	Micro Fleece Upper – Polyester Lower	Micro Fleece Upper – Polyester Lower
Detachable Centre Layer	●	●
Oval Face Cut Out	●	●
10mm Heavy Duty Crash Zips	●	●
Internal & External Zip Baffles	●	●
3 Point Bed Attachment	●	●
Compression Stuff Sack	●	●
Thermal Foot Pocket	●	●
Pillow Retention Draw Cord	●	●
Mesh Side Storage Pockets	●	●
Sleeping Bag Size	SIZE XL	SIZE STANDARD

BLAX 3 SEASON XL

BLAX 3 SEASON

SLEEPING BAG 2/3 SEASONS

NEW 2025



768

NEW 2025



768



769

ACS520058	ACS520044	ACS520059
EXCEPTIONAL VALUE		GREAT VALUE AND PERFORMANCE
0°	0°	5-10°
Silicon Treated 3 Season Hollow Fibre	Silicon Treated 3 Season Hollow Fibre	Hollow Cotton
Water Resistant 190T Polyester	Water Resistant 190T Polyester	Polyester
190T Polyester	190T Polyester	Polyester
—	—	—
●	●	●
●	●	8mm Heavy Duty Crash Zips
●	●	—
●	●	●
●	●	●
●	●	●
●	●	●
—	—	—
SIZE XL	SIZE STANDARD	SIZE STANDARD

MAGNUM 5 SEASON

- Sets a new standard in bankside comfort, even when fishing in the most extreme conditions.
- Featuring a 5 Season silicone treated Hollow Fibre filling and a detachable central layer, it is incredibly versatile allowing extra warmth to be added or removed as the temperature changes throughout the year.
- **Filling:** 5 Season Hollow Fibre filling with silicone treatment for increased volume & longevity.
- **Outer:** Waterproof Rip-Stop Polyester outer fabric.
- **Lining:** Unique 50/50 lining – Micro fleece upper / Smooth Rip-Stop polyester lower.



SIZE STANDARD

Perfect with our range of beds: Pages 747-748.



MIN TEMP
-20°C ❄️

SIZE XL

THE DETAIL

- 1 Fully detachable centre layer.
- 2 Oval cut out – Allows you to be fully zipped in for maximum warmth.
- 3 Closely spaced full length panel stitching.
- 4 Velcro base – XL / Draw cord base – Standard.
- 5 Side zips stop short at the base creating a thermal pocket around your feet.
- 6 Oversized external/internal zip baffles.
- 7 Hooded pillow retention draw cord.



Large neck polar fleece baffles to keep you warm.



10mm heavy-duty crash zips.



Velcro leg cut outs to help secure to bed.



Supplied in stuff sack.



Zipped mesh pockets on both sides.



Oversized head to secure to bed.



Central securing strap.

CODE	SIZE	MINIMUM TEMP RATING	GENCOD	TRADE PACK	RRP (€)
MAGNUM 5 SEASON					
ACS520040 (XL)	230 x 115	-20°		1	209.99
ACS520041 (STD)	220 x 95	-20°		1	176.99

**DETACHABLE CENTRE LAYER
ALLOWS YOU TO CONVERT THE
MAGNUM 5 SEASON SLEEPING
BAG INTO A 4 SEASON VERSION
IN WARMER TEMPERATURES.**

**THE ULTIMATE
IN COMFORT,
WARMTH AND
FLEXIBILITY**

MAGNUM 4 SEASON



SIZE STANDARD



- A true all-season bag that provides outstanding performance thanks to its 4 season silicone treated Hollow Fibre filling.
- The unique 50/50 lining uses Micro fleece around the head and body area, which is instantly warm to the touch, whilst the lower part of the bag is made using smooth rip stop material to reduce the chances of the bag pulling and catching on your legs.
- **Filling:** 4 season Hollow Fibre filling with silicone treatment for increased volume & longevity.
- **Outer:** Waterproof Rip-Stop Polyester outer fabric.
- **Inner:** Unique 50/50 lining – Micro fleece upper / Smooth Rip-Stop polyester lower.



SIZE XL

MIN TEMP -10°C ❄️

Perfect with our range of beds: Pages 747-748.

THE DETAIL

- 1 Oval cut out – Allows you to be fully zipped in for maximum warmth.
- 2 Closely spaced full length panel stitching.
- 3 Velcro base – XL / Draw cord base – Standard.
- 4 Side zips stop short at the base to creating a thermal pocket around your feet.
- 5 Oversized external/internal zip baffles.
- 6 Hooded pillow retention draw cord.



Large neck polar fleece baffles to keep you warm.



10mm heavy-duty crash zips.



Velcro leg cut outs to help secure to bed.



Supplied in stuff sack.



Zipped mesh pockets on both sides.



Oversized head to secure to bed.



Central securing strap.

CODE	SIZE	MINIMUM TEMP RATING	GENCOD	TRADE PACK	RRP (€)
MAGNUM 4 SEASON					
ACS520042 (XL)	230 x 115	-10°		1	145.99
ACS520043 (STD)	220 x 95	-10°		1	124.99

UNSURPASSED COMFORT AT EXCEPTIONAL PRICE POINTS.

EXCEPTIONAL
VALUE!

BLAX 3 SEASON

Perfect with our range of beds: Pages 747-748.

- Offers fantastic value and performance plus a host of features normally associated with sleeping bags twice the price.
- Ideal for use in Spring, Summer or Autumn, thanks to its 3-season silicone treated hollow fibre filling; it offers excellent insulation yet is still lightweight and practical.
- **Filling:** 3 season Hollow Fibre filling with silicone treatment for increased volume & longevity.
- **Outer:** Water resistant 190T polyester.
- **Inner:** Smooth micro weave polyester.



Large neck baffles to keep you warm.



10mm heavy-duty crash zips.



SIZE STANDARD



Supplied in stuff sack.

SIZE XL

MIN TEMP
0°C ❄️

THE DETAIL

- 1 Oval cut out – Allows you to be fully zipped in for maximum warmth.
- 2 Closely spaced full length panel stitching.
- 3 Side zips stop short at the base to creating a thermal pocket around your feet.
- 4 Draw cord base.
- 5 Oversized external/internal zip baffles.
- 6 Hooded pillow retention draw cord.



Oversized head to secure to bed.



Velcro leg cut outs to help secure to bed.



Central securing strap.

CODE	SIZE	MINIMUM TEMP RATING	GENCOD	TRADE PACK	RRP (€)
BLAX 3 SEASON					
ACS520058 (XL)	230 x 115	0°		1	99.99
ACS520044	220 x 95	0°		1	83.99

NEW 2025

CARPSPIRIT SLEEPING BAG 2/3 SEASONS

NEW 2025

- Offers fantastic value and performance and combines perfectly with our CS 6 Legs Bed Chair.
- Min Temp Rating: 5°.
- 220 x 95cm.

CARPSPIRIT
SLEEPING BAGS

CODE	SIZE (CM)	MINIMUM TEMP RATING	GENCOD	TRADE PACK	RRP (€)
SLEEPING BAG 2/3 SEASONS					
ACS520059	220 x 95	5°		1	63.99

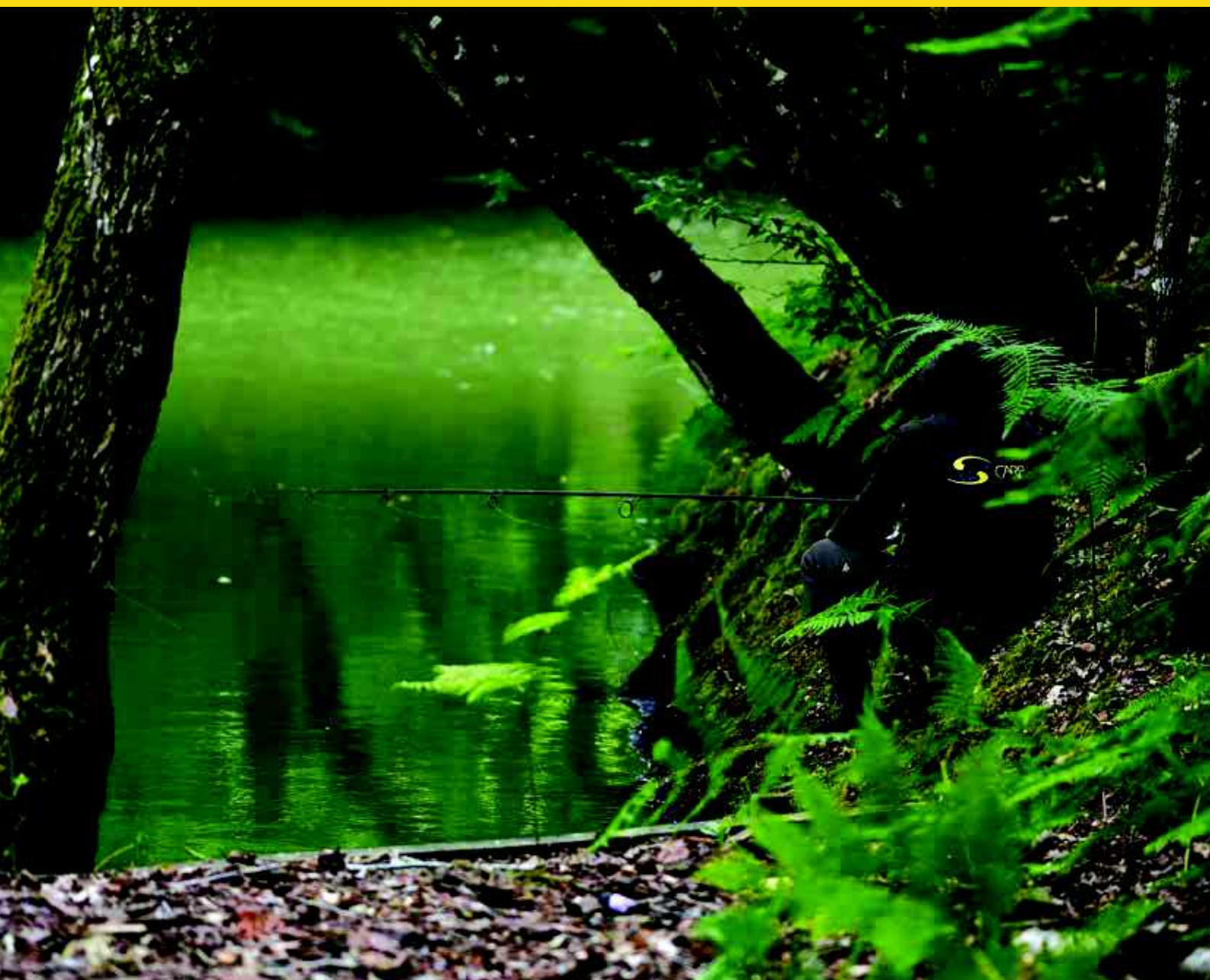

BLAX HALF MOON PILLOW

- The perfect pillow with the perfect shape – specially designed to fit sleeping bags.
- Fully reversible: featuring a micro fleece covering on one side that's instantly warm to the touch and ideal for the winter use, and a cool peach skin fabric on the other, perfect for the summer.
- Fits both Standard and XL Carp Spirit Sleeping Bags.



CODE	SIZE	MINIMUM TEMP RATING	GENCOD	TRADE PACK	RRP (€)
HALF MOON PILLOW					
ACS520046	85 x 55	–		1	20.99



CARLOS POLO 
 [@polo_carp_angler](https://www.instagram.com/polo_carp_angler)

LUGGAGE & TRANSPORT

CARP SPIRIT | LUGGAGE & TRANSPORT





MAGNUM RIGID BAG

- Rigid support bag for ultimate protection of your rods and reels.
- Two separate compartments to accommodate two rods (with 50mm rings).
- Features outer storage pocket for accessories.
- EVA carry handle and fully adjustable EVA shoulder strap.



CODE	SIZE (CM)	RODS (FT)	WEIGHT (KG)	GENCOD	TRADE PACK	RRP (€)
RIGID BAG						
ACS070006	27 x 220	13	3.10		1	98.99
ACS070081	27 x 205	12	3.00		1	85.99

MAGNUM MULTI SLEEVE

- Maximum protection for rods and reels due to thick padded internal dividers.
- Single zip to main compartment for quick access.
- Fully adjustable and padded nonslip EVA shoulder strap.
- Landing net handle will attach to the outside to act as a spine.
- Will accept 50mm butt guides.

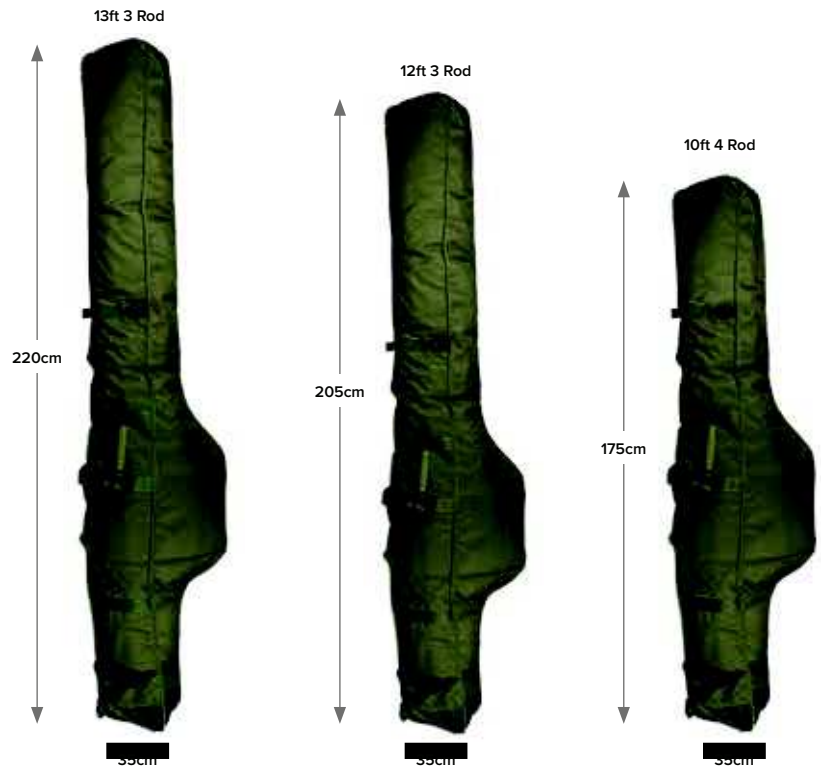

CODE	SIZE (CM)	RODS (FT)	WEIGHT (KG)	GENCOD	TRADE PACK	RRP (€)
MAGNUM MULTI SLEEVE						
ACS070051	35 x 220	13 (3 rods)	1.75		1	78.99
ACS070082	35 x 205	12 (3 rods)	1.65		1	75.99
ACS070075	35 x 175	10 (4 rods)	1.75		1	81.99



BLAX ROD SLEEVE

- Individual rod sleeve with central partition.
- EVA carry handle.
- Access zip located on the opposite side of reel to prevent catching and damage to mainline or braid.



CODE	SIZE (CM)	RODS (FT)	WEIGHT (KG)	GENCOD	TRADE PACK	RRP (€)
BLAX ROD SLEEVE						
299001360	24 x 220	13	0.95		1	32.99
124400360	24 x 205	12	0.90		1	31.99
147700360	24 x 175	10	0.76		1	29.99



CHRISTOPHE BELIARD

@bebelcarpangler

BLAX BASIC SLEEVE

- Case in cordura 500 D.
- Large reel pockets
- Umbrella pocket.
- Rod pod/bankstick pocket.



CODE	SIZE (CM)	RODS (FT)	WEIGHT (KG)	GENCOD	TRADE PACK	RRP (€)
BASIC SLEEVE						
147600360	30 x 212	13 (4 Rods)	2.2		1	53.99

BLAX ROD END PROTECTOR

- Two per pack (butt and tip).
- Adjustable Velcro fastener.



CODE	SIZE (CM)	WEIGHT (KG)	GENCOD	TRADE PACK	RRP (€)
ROD END PROTECTOR					
125400360	—	0.10		1	11.99

BLAX ROD HOLDER

- Neoprene end protector for rods during transport and storage.
- Velcro fastener to adjust the tightening.
- 2 per pack (Small – for the tip, Large – for the butt section).



CODE	SIZE (CM)	WEIGHT (KG)	GENCOD	TRADE PACK	RRP (€)
ROD HOLDER					
714001361	26&15	0.10		1	8.49

MAGNUM CARRYALL

- Large main compartment, perfect for clothes or large accessories.
- 2x padded side zip pockets, and 2x end quick access pockets, perfect for accessories.
- Fully padded main front pocket is compatible with large Carp Spirit tackle boxes.
- Additional padded front pocket on the XL size.
- EVA carry handles and fully adjustable EVA shoulder strap.
- Heavy duty reinforced base.
- 2 sizes: M / L.

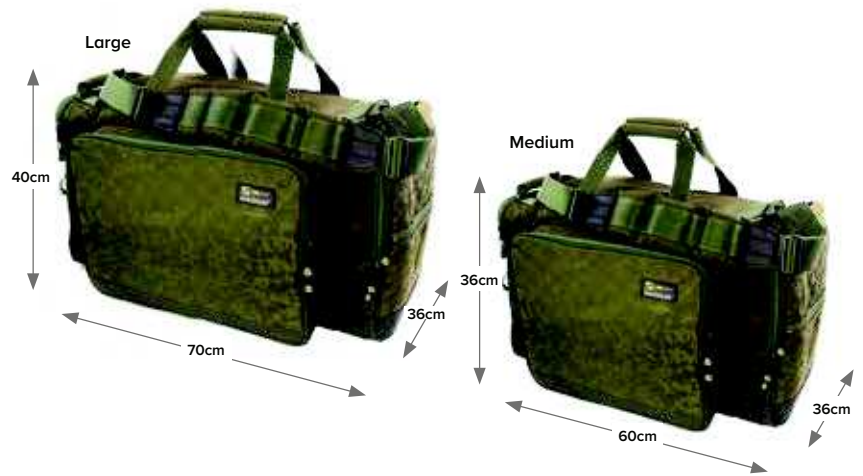

CODE	SIZE (CM)	WEIGHT (KG)	GENCOD	TRADE PACK	RRP (€)
MAGNUM CARRYALL					
ACS070054 (L)	70 x 36 x 40	2.25		1	98.99
ACS070053 (M)	60 x 36 x 36	1.90		1	82.99

BLAX CARRYALL

- Multi-compartment carryalls, perfect for short and medium sessions. Manufactured from high-quality material, complete with easy access external pockets, hand carry handles and an adjustable shoulder strap.
- Two sizes -
 - Small: 48 x 26 x 28cm
 - Medium: 58 x 32 x 32cm



CODE	SIZE (CM)	WEIGHT (KG)	GENCOD	TRADE PACK	RRP (€)
BLAX CARRYALL					
ACS070084 (M)	58 x 32 x 32	1.5		1	69.99
ACS070085 (S)	48 x 26 x 28	1.15		1	59.99



BLAX MULTI CARRYALL

**BEST
SELLER**

- Constructed using a folding Aluminium frame, it is perfect for terminal tackle and accessory storage.
- When open, the folding top section unveils 2 quick access pockets. When in this position, the central section can also act as a workstation / table.
- The carryall is supplied with 2 large storage boxes (in large base pocket), 1 medium store box (inside folding pocket) and 3 small storage boxes (inside folding pocket).



CODE	SIZE (CM)	WEIGHT (KG)	GENCOD	TRADE PACK	RRP (€)
BLAX MULTI CARRYALL					
ACS070008	40 x 24 x 32	3.50		1	109.99





CARP SPIRIT'S RANGE OF WATERPROOF HYDRO LUGGAGE IS PERFECT FOR KEEPING ITEMS OF TACKLE NEAT, TIDY, ORGANISED AND DRY DUE TO ITS TECHNICALLY ADVANCED WELDED SEAM CONSTRUCTION. WHETHER ON THE BANK, OR ON THE MOVE, THE HYDRO LUGGAGE IS THE PERFECT TRANSPORT OPTION FOR ALL YOUR TACKLE AND ACCESSORY NEEDS.

HYDRO BAGS

- 2 models available: 2600 or 3520.
- Waterproof material with welded seam construction.
- EVA 1.5mm body.
- Impact resistant 1 piece moulded waterproof base and lid.
- Anti-Slip base.

Adjustable shoulder strap (2600 model).
Side clasp handle carry straps (3520 model).



CODE	SIZE (CM)	CAPACITY (L)	WEIGHT (KG)	GENCOD	TRADE PACK	RRP (€)
HYDRO BAGS						
ACS140019 (3520)	45 x 29 x 27	35.20	—		1	73.99
ACS140018 (2600)	40 x 26 x 25	26.00	—		1	62.99

HYDRO BOXES

- 4 models available; 122, 126, 213, 343.
- Waterproof material with welded seam construction.
- EVA 0.85mm body & 1.5mm bottom.
- UV Resistant smoked lid.

* Mesh pocket lid insert (343 model only).



BEST SELLER

CODE	SIZE (CM)	CAPACITY (L)	WEIGHT (KG)	GENCOD	TRADE PACK	RRP (€)
HYDRO BOXES						
ACS140014 (122)	14 x 12.5 x 7	1.22	—		1	16.99
ACS140015 (126)	20 x 9 x 7	1.26	—		1	16.99
ACS140016 (213)	21 x 14.5 x 7	2.13	—		1	17.99
ACS140017 (343)	24.5 x 17.5 x 8	3.43	—		1	21.99

CARP SPIRIT BAKKAN 30L NEW 2025

- The Carp Spirit Bakkan is a multi-purpose waterproof bag made from EVA, with a zippered lid and a watertight base.
- 30L capacity.
- EVA construction – thickness: body 1mm, bottom 1.5mm, cover 0.85mm.
- The ideal carryall to protect essential items from external moisture.
- Reinforced handles and carry strap.
- Plastic zipper in XL size.
- 42x28x26cm.



CODE	SIZE (CM)	CAPACITY (L)	GENCOD	TRADE PACK	RRP (€)
BAKKAN 30L					
ACS070096	42 x 28 x 26	30		1	34.99

BLAX SPOOL CASE

- Heavy duty spool case that offers maximum protection.
- Designed to store 4 spare spools.

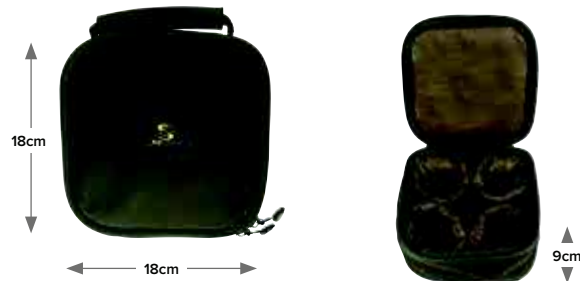

CODE	SIZE (CM)	CAPACITY (L)	WEIGHT (KG)	GENCOD	TRADE PACK	RRP (€)
SPOOL CASE						
293001360	18 x 18 x 9	—	0.18		1	17.49



BLAX CAMPING SET

- Set featuring: 2 plates, 2 forks, 2 knives, and 1 small towel.



CODE	SIZE (CM)	CAPACITY (L)	WEIGHT (KG)	GENCOD	TRADE PACK	RRP (€)
BLAX CAMPING SET						
987000361	26 x 24	—	0.82		1	29.99

BLAX CAMPING SET DELUXE

- Contains 2 plates, 2 forks, 2 knives, 2 spoons, 2 cups and 1 thermos flask and 2 small towels.



CODE	SIZE (CM)	CAPACITY (L)	WEIGHT (KG)	GENCOD	TRADE PACK	RRP (€)
BLAX CAMPING SET DELUXE						
ACS010183	31 x 25 x 10	—	1.86		1	79.99

CARPSPIRIT SESSION TROLLEY

- A lightweight, space-saving trolley designed to transport your equipment wherever your vehicle cannot go.
- Delivered with 2 elastic straps with hooks.
- Storage cover on the front.
- Maximum load 100kg.



CODE	WIDTH (CM)	LENGTH EXTENDED (CM)	WEIGHT (KG)	GENCOD	TRADE PACK	RRP (€)
SESSION TROLLEY						
ACC070008	60	140	6.5		1	104.99
SESSION TROLLEY SPARE WHEEL						
ACC070009	—	—	1.10		1	14.99

BIVVIES & SHELTERS



BIVVIES & SHELTERS

MINI DOLMEN

EVEREST 1 MAN

MAGNUM 100 BIVVY

BLAX RAZORLITE BIVVY



784



785



786



787

Product Code	ACS540039	ACS540046	ACS540055	ACS540057
Key USP	FEATURE PACKED COMPLETE WITH WINTER SKIN	SUPER STRONG AND LIGHT FRAME	OUR HIGHEST PERFORMANCE BIVVY	THE PERFECT ALLROUND BIVVY
Dimensions (cm)	260 x 180 x 300	260 x 142 x 240	250 x 140 x 185	280 x 140 x 190
Weight (kg)	19	15	7.5	4.2
Capacity	1+	1+	1	1
Hydro-Skin Fabric			●	
Arma-Skin Fabric	●	●		
PU Fabric 200D				●
PU Fabric 210D				
Hydrostatic Head mm2	10,000	10,000	20,000	8,000
Breathable	●	●		
Half winterskin included	●			
Double entry	●			
Velcro Rod supports	●	●	●	●
Winter Skin Available	●	●		●
Reinforced zips	●	●	●	●
Thermo-Welded seams	●	●	●	●
Transparent window(s)	●	●		
Mosquito mesh window(s)	●	●	●	●
Vented Roof with Mosquito Mesh	●			
Rear Panel Vents		●	●	
Removable front panel		●	●	●
Aluminium Frame	●	●	●	●
Fibreglass Frame				
Storm poles included			●	
Heavy Duty Groundsheet	●	●	●	
PE Groundsheet				●
Moulded screw pegs	●	●	●	●
Carry bag	●	●	●	●



**BLAX 1
MAN BIVVY**

OUTHOUSE XL

SPEED-R

**BLAX RAZORBACK
BROLLY**

SCS+



788



789



790



791



792

ACS540049	ACS540036	ACS540043	ACS540059	ACS540054
EXCEPTIONAL PERFORMANCE AND VALUE	SPACIOUS MULTI USE BIVVY	QUICK & EASY ERECT	INCREDIBLE VALUE AND PRICE	SUPER COMPACT AND PORTABLE
275 x 140 x 205	220 x 210 x 150 220 x 220 x 250	290 x 150 x 230	270 x 180 x 200	220 x 120 x 120
8	14.6 / 18.5	15.5	4.5	5.4
1+	1	1	1	1
●	●	●	●	●
5,000	5,000	10,000	8,000	10,000
●	●	●	●	●
●	●	●	●	●
●	●	●	●	●
●	●	●	●	●
●	●	●	●	●
●	●	●	Additional Purchase	●
●	●	●	●	●
●	●	●	Additional Purchase	●
●	●	●	●	●
●	●	●	●	●
●	●	●	●	●
●	●	●	●	●
●	●	●	●	●
●	●	●	●	●
●	●	●	●	●



MINI DOLMEN

ALL SEASON
SUPPLIED WITH
HALF WINTERSKIN



- Featured packed bivvy, perfect for long sessions on the bank.
- Constructed using ARMA-SKIN™ fabric (10,000mm² Hydrostatic Head), on a unique Aluminium frame design, the Mini Dolmen offers a spacious bivvy that is incredibly strong and stable.
- 180cm height makes it possible for most to fully stand inside.
- The front and back panels can be fully rolled back, and feature side mosquito meshes and multi-configuration doors that can be used in closed, mosquito, or clear PVC window.
- Double door entry – door at each end of the bivvy for easy access.
- Mesh roof design for maximum ventilation.
- Heavy duty groundsheet, heavy duty moulded ‘T’ pegs, and oversized carry bag included.
- Supplied with a half Winter Skin as standard, a full Winter Skin is also available separately for added comfort in the most extreme conditions.

NET PRICE

CODE	DIMENSIONS W/H/D (CM)	WEIGHT (KG)	GENCOD	TRADE PACK	NET PRICE (€)
MINI DOLMEN					
ACS540039	260 x 180 x 300	19.0		1	226.00

EVEREST 1 MAN

SUPER STRONG
AND LIGHTWEIGHT
FRAME



Winterskin



- The Everest 1 man bivvy is both quick and easy to erect.
- Constructed using ARMA-SKIN™ fabric (10,000mm² Hydrostatic Head), on a 4 rib Aluminium frame, it is incredibly strong and stable.
- The extended front rib provides additional protection and cover over the door area from the elements, particular useful for when using the front door 'letterbox' style.
- The fully removable front panel features side mosquito meshes and a multi-configuration door that can be used in closed, mosquito, or clear PVC window.

- Rear mosquito vents have also been added for increased ventilation and velcro rod support straps have been added to the frame as standard.
- Heavy duty groundsheet, heavy duty moulded 'T' pegs, and oversized carry bag included.
- A full Winter Skin* is also available separately for added comfort in the most extreme conditions.

NET PRICE

* Will accept two Beds with front panel removed and Winter skin fitted. Mini porch groundsheet supplied to be used for this configuration.

CODE	DIMENSIONS W/H/D (CM)	WEIGHT (KG)	GENCOD	TRADE PACK	NET PRICE (€)
EVEREST 1 MAN					
ACS540046	260 x 142 x 240	15.0		1	177.00

MAGNUM 100 BIVVY



Camo Zip in Mozzi Mesh.



- The feature packed Magnum 100 bivvy is constructed using a 2-piece 360-degree centre block that enables rapid setup and pack down.
- The lightweight aluminium frame with individual leg tension bungees, and moulded elbow joints, ensures reliability and confidence even in the harshest of conditions.
- Wrapped in our high-performance HYDRO-SKIN material (20,000mm² Hydrostatic Head) that features black out technology, the bivvy is the perfect option for harsh winters and light summer mornings.
- The flat back design allows beds to be placed towards the back creating more useable floor space and increased headroom.
- Additional features include; height adjustable splay frame design, 2x Rear Mosquito vents, thermally taped seams throughout, Velcro rod straps, zip off front infill panel (infill panel sides can also be rolled and clipped back), solid centre door with mosquito mesh – can be fished 'letter box' style, internal mesh storage pockets.
- Heavy duty groundsheet, heavy duty storm poles, heavy duty Moulded 'T' pegs and oversized carry bag included.
- Camo Mosquito Mesh full zip front Panel available separately.



CODE	DIMENSIONS W/H/D (CM)	WEIGHT (KG)	GENCOD	TRADE PACK	NET PRICE (€)
MAGNUM 100 BIVVY					
ACS540055	250 x 140 x 185	7.5		1	198.00
MAGNUM 100 BIVVY ZIP-IN MOZZY MESH					
ACS540056	—	—		1	13.85

BLAX

RAZORLITE BIVVY

LIGHT & FAST BUILD



- A lightweight bivy that can be configured to suit a host of different situations. Fish without the front as a day shelter for short sessions or when on the move, add the front to become a bivvy, or add the winterskin for extreme weather conditions.
- Constructed using tough and durable 200D Nylon PU Fabric (8000mm² Hydrostatic Head), and 7001 Aerospace grade flexible Aluminium poles, the Razorlite is the ultimate lightweight bivvy.
- Zip in front panel and be fully removed or rolled and clipped back.

- Solid center door with mosquito mesh – can be fished 'letter box' style.
- Thermally taped seams throughout.
- Velcro rod straps.
- Medium weight PVC groundsheet, heavy duty molded 'T' pegs, and oversized carry bag included.
- A full Winter Skin is also available separately for added comfort in the most extreme conditions.

NET PRICE

CODE	DIMENSIONS W/H/D (CM)	WEIGHT (KG)	GENCOD	TRADE PACK	NET PRICE (€)
BLAX RAZORLITE BIVVY					
ACS540057	280 x 140 x 190	4.2		1	198.00
ACS540058 (Winterskin)	—	1.1		1	46.00

BLAX™ BIVVY



EXCEPTIONAL PERFORMANCE AND VALUE

BEST SELLER



Winterskin

- Constructed using tough & durable 210D PU backed nylon (5,000mm² hydrostatic head), with thermally taped seams throughout.
- 2-rib design Aluminium main frame is lightweight and features a front porch peak – perfect for when fishing the front door letter box style.
- Sides mosquito vents can be used by simply rolling back the covers.
- The front door features 3 options of closed, PVC or Mosquito mesh.
- The front itself can be completely rolled back and clipped into place to provide maximum visibility of the lake.
- Durable lightweight PU groundsheet, heavy duty moulded 'T' pegs, and oversized carry bag included.
- Available in 1- and 2-man options
- A full Winter Skin is also available separately for both sizes for added comfort in the most extreme conditions.

NET PRICE

CODE	DIMENSIONS W/H/D (CM)	WEIGHT (KG)	GENCOD	TRADE PACK	NET PRICE (€)
BLAX 1 MAN					
ACS540049	275 x 140 x 205	8.0		1	109.00
ACS540050 (Winterskin)	—	3.4		1	48.00

OUTHOUSE XL



**SPACIOUS
MULTI USE
BIVVY**



- The Outhouse is a perfect shelter for cooking, storing extra equipment, or even as a back-up bivy.
- The tall design allows you to stand up inside unhindered.
- Both the front and back can be fully opened for dual entry and to create excellent ventilation, particularly useful when cooking.
- PU Fabric 210D - Hydrostatic head: 5,000mm².
- Storm poles included.
- PE groundsheet, heavy duty moulded T pegs, and oversized carry bag included.

**PERFECT FOR
EUROPEAN
FISHING TRIPS**

**NET
PRICE**

CODE	DIMENSIONS W/H/D (CM)	WEIGHT (KG)	GENCOD	TRADE PACK	NET PRICE (€)
OUTHOUSE XL					
ACS540036	220 x 220 x 250	18.5		1	154.00

SPEED-R



**QUICK
& EASY
ERECT**



Winterskin

- Based on a brolly frame design, the Speed-R is super quick to erect making it ideal for short to medium sessions or for anglers wanting to stay mobile.
- The special internal rib design offers excellent headroom when sat down inside.
- ARMA-SKIN™ fabric – Hydrostatic Head 10,000mm².
- Zip in front – solid, clear, mozzi mesh.

- 2x large rear vents.
- 4x storm poles included.
- Heavy duty groundsheet, heavy duty moulded 'T' pegs, and oversized carry bag included.
- A full Winter Skin is also available separately for added comfort in the most extreme conditions.

**NET
PRICE**

CODE	DIMENSIONS W/H/D (CM)	WEIGHT (KG)	GENCOD	TRADE PACK	NET PRICE (€)
SPEED-R					
ACS540043	290 x 150 x 230	15.5		1	199.00

BLAX™

RAZORBACK BROLLY

CARP SPIRIT | BIVVIES & SHELTERS



Zip-in Front

- Flat back design – allows bedchair to be placed towards the back creating more useable floor space.
- Detachable centre pole for increased headroom.
- 8,000mm Hydrostatic Head / 200D Nylon PU fabric.
- Thermally taped seams throughout.
- Velcro rod straps.
- Infill panel sides can be rolled and clipped back.

- Storm poles included.
- Medium weight PVC groundsheet included.
- Heavy duty Moulded T pegs included.
- Oversize carry bag with double zips.
- Zip off front infill panel sold separately – solid centre door with mosquito mesh. Can be fished 'letter box' style.

NET PRICE

CODE	DIMENSIONS W/H/D (CM)	WEIGHT (KG)	GENCOD	TRADE PACK	NET PRICE (€)
BLAX RAZORBACK BROLLY					
ACS540059	270 x 180 x 200	4.5		1	100.00
ACS540060 (Zip-in Front)	—	—		1	26.50

SCS+ (SUPER COMPACT SHELTER +)

SUPER COMPACT AND PORTABLE



- Perfect for anglers on the move or quick overnight sessions, the small footprint is ideal for tight swims or wooden platforms.
- Lightweight, compact & highly portable, the SCS+ features a space saving design that fits snugly around our latest ranged of 6 & 8 Leg bed chairs.

- ARMA-SKIN™ fabric – Hydrostatic Head 10,000mm².
- Lightweight pop-up fibreglass frame.
- Heavy duty groundsheet, heavy duty moulded 'T' pegs, and oversized carry bag included.

NET PRICE

CODE	DIMENSIONS W/H/D (CM)	WEIGHT (KG)	GENCOD	TRADE PACK	NET PRICE (€)
SCS+					
ACS540054	220 x 120 x 120	6.2		1	102.00

BLAX BIVVY TABLE MEGA

- Foldable, telescopic legs with "oversized feet" for better stability.
- Light Aluminium structure.
- Transport handle.



CODE	WIDTH (CM)	DEPTH (CM)	HEIGHT (CM)	WEIGHT (KG)	GENCOD	TRADE PACK	RRP (€)
BIVVY TABLE MEGA							
ACS070011	65	45	40-60	2.95		1	53.99

CARPSPIRIT BIVVY TABLE SMALL

- A Bivvy Table with a four-compartment top, ideal for separating different pieces of kit.
- Easily adjustable, telescopic legs with mudfeet.
- Designed so the legs and feet fold-away underneath for easy transportation and storage.



CODE	WIDTH (CM)	LENGTH (CM)	HEIGHT (CM)	WEIGHT (KG)	GENCOD	TRADE PACK	RRP (€)
BIVVY TABLE SMALL							
ACS540062	29	54	29-39	1.45		1	31.49



CARPSPIRIT HAMMER + 12 BIVVY PEG SET

- 12 robust screw-in pegs.
- Rubber mallet with soft grip handle.
- Cordura transport bag.



CODE	WIDTH (CM)	DEPTH (CM)	HEIGHT (CM)	CAPACITY (L)	WEIGHT (KG)	GENCOD	TRADE PACK	RRP (€)
HAMMER + 12 BIVVY PEG SET								
ACS540019	35	9	—	—	1.68		1	37.99

CARPSPIRIT FOLDING SHOVEL

- A strong and versatile foldable shovel, supplied with a transport bag.
- Size of the shovel head: 21x15cm.
- Total length: 58cm.
- Folded length: 24cm.



CODE	WIDTH (CM)	DEPTH (CM)	HEIGHT (CM)	CAPACITY (L)	WEIGHT (KG)	GENCOD	TRADE PACK	RRP (€)
FOLDING SHOVEL								
ACS070019	—	—	—	—	1.10		1	15.99

CARPSPIRIT PORTABLE SHOWER

- 20l portable shower.
- Leave shower in the sun to help increase the temperature of the water.
- Warning: it is advised to rinse out the shower between each use.



CODE	WIDTH (CM)	DEPTH (CM)	HEIGHT (CM)	CAPACITY (L)	WEIGHT (KG)	GENCOD	TRADE PACK	RRP (€)
PORTABLE SHOWER								
126300360	—	—	—	20	—		1	10.49

ALARMS & INDICATORS

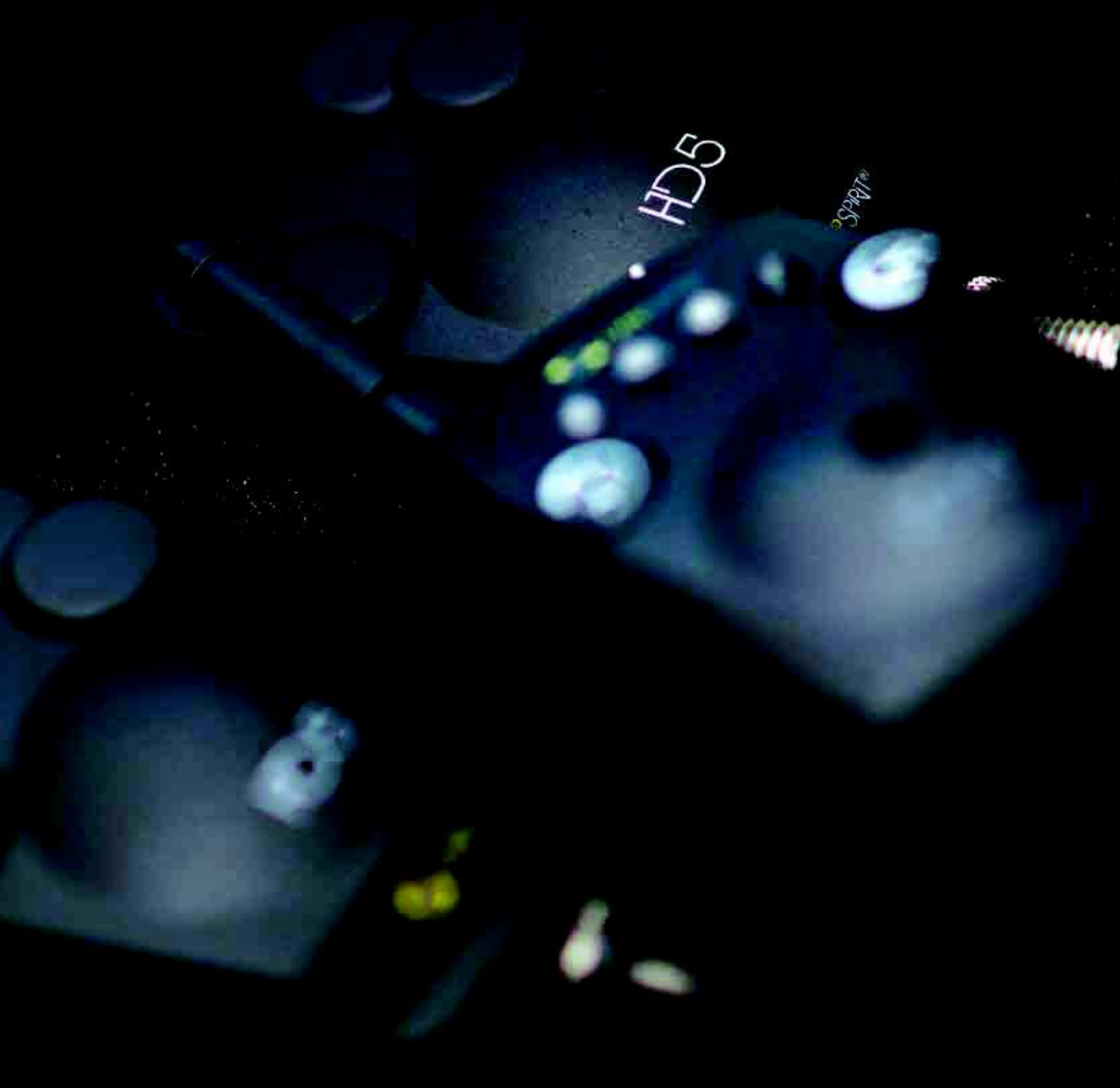

ALARMS & INDICATORS



Key USP	QUALITY, FEATURE PACKED ALARMS		NEW AND IMPROVED XTE MODEL	
	HD5	HD5R	HD4	HD4R
ON/OFF switch	●	●	●	●
Volume control	●	●	●	●
Tone control	●	●	●	●
Sensitivity control	●	—	●	—
Vibration	—	●	—	●
Mute feature	●	●	●	●
Drop back differentiate	●	—	●	—
Colour	●●●●●●	●●●●●●	●●●●	●●●●
Range	up to 150m	up to 150m	up to 150m	up to 150m
2.5mm jack output	●	—	●	—
Detachable Snag Ears	—	—	●	—
Number of LEDs	2	4	2	4
Multi-coloured LEDs	●	●	●	●
LED latching time (seconds)	20	20	15	15
Manual night mode	●	—	●	—
Low battery alarm	●	●	●	●
Battery type (not supplied)	x1 9v	x1 9v	x1 9v	x3 AAA 1.5v
All weather construction	●	●	●	●
Stainless steel screw thread	●	—	●	—
Clip on protection case	●	—	●	—
Accessory	—	Lanyard / Table Stand	—	Lanyard / Table Stand





BEST SELLING COMPACT ALARM		OUTSTANDING FEATURES AND VALUE		GREAT VALUE ALARM		AMAZING TRADE PRICE	THE BEST VALUE FOR MONEY
●	●	●	●	●	●	●	●
—	●	●	●	●	●	●	●
—	●	●	●	●	●	●	●
●	—	●	—	●	—	●	—
—	●	—	●	—	—	—	—
●	●	●	●	●	●	●	—
●	●	●	—	—	—	—	—
●●●●●●●●	●●●●●●●●	●●●●●●●●	●●●●●●●●	●	●	●●●●●●	●
up to 150m	up to 150m	100-120m	100-120m	up to 150m	up to 150m	—	—
●	—	—	—	●	—	●	●
—	—	—	—	—	—	—	—
2	4	2	4	1	4	1	1
●	●	●	●	—	—	●	—
20	20	15	15	20	20	20	20
●	—	●	—	●	—	●	—
●	●	●	●	●	●	●	—
x1 V23GA 12V	x1 PP3 9V	x1 9v	x1 9v	x1 9v	x3 AAA 1.5v	x1 9v	x1 V23GA 12V (supplied)
●	●	●	●	●	●	●	—
●	—	●	—	●	—	●	—
●	—	—	—	—	—	—	—
—	Lanyard / Table Stand	—	—	—	Lanyard	—	—



ALARM

HD5

- Since its launch, the HD5 has become a firm favourite with carp anglers. Incorporating some of the latest technology available in electronic bite indication, the HD5 really does tick all the boxes. Reliability, long battery life and a quality build, nothing has been overlooked.
- Feature packed with dial adjustable sensitivity, 6 colour LED (Red, Green, Blue, Yellow, Purple & White), 20 second latching, 20 second afterglow period on alarm and receiver, 150m range, remote range self-testing, connection ring on receiver to secure it, low battery warning, nightlight mode, power out socket for illuminated bobbins, and a quality ABS body.
- A digital rolling code system also allows extra alarms to be purchased separately and programmed to an existing receiver.

HD5 x4 HD5R x1



HD5 x3 HD5R x1



HD5 x2 HD5R x1

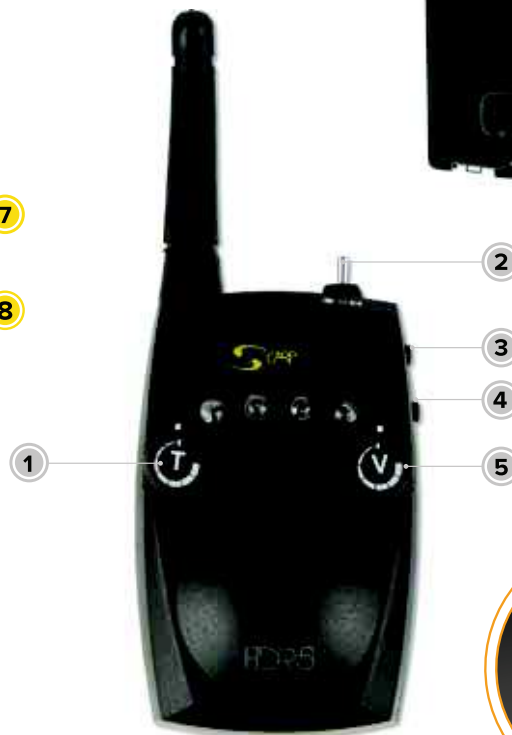

THE DETAIL

- 1 Ultra-bright long life LED.
- 2 Tone control.
- 3 LED colour control.
- 4 Power out socket.
- 5 Stainless steel screw thread.
- 6 Soft rubber non-slip insert.
- 7 Volume control.
- 8 Sensitivity control.
- 9 On/off power / vibration switch.



HD5 Protective covers included.

THE DETAIL

- 1 Tone control.
- 2 On/off power / vibration switch.
- 3 LED Colour button.
- 4 LED Selection button.
- 5 Volume control.



HD5R with table support and belt clip included.

Both the bite alarm and the receiver operate on a 9V battery (not supplied).

CODE	ALARM QUANTITY	RECEIVER QUANTITY	GENCOD	TRADE PACK	RRP (€)
HD5 ALARMS AND HD5R RECEIVER					
ACS490013	4	1		1	409.99
ACS490014	3	1		1	314.99

ALARM

HD4

- The latest addition to the HD alarm range, the HD4 model offers a high quality, multi-function alarm option. Based on the previous XTE model chassis, the upgraded circuit boards, and functionality result in a high-performance great value alarm that won't let you down.
- Adjustable 4 colour LED (Red, Yellow, Green, Blue), 15 second latching time, 30 second 'mute' feature, detachable black snag ears, 4 level volume, tone, and sensitivity settings, drop back differentiation, nightlight mode, up to 150m range, 2.5mm power out socket, low battery warning, and high impact ABS moulded construction.



HD4 x4 HD4R x1



HD4 x3 HD4R x1



HD4 x2 HD4R x1



THE DETAIL

- 1 Detachable snag ears.
- 2 Ultra-bright long life LED.
- 3 Nightlight.
- 4 Stainless steel screw thread.
- 5 Power out socket.
- 6 Soft rubber non-slip insert.
- 7 On / off power / nightlight button.
- 8 Volume control.
- 9 Tone control.
- 10 Sensitivity control.



HD4 protective covers included.

THE DETAIL

- 1 On / off power button.
- 2 Volume control / vibration function.
- 3 Tone control.



HD4R table support and lanyard included with sets.

Alarm uses 9V battery (not supplied). Receiver uses 3x AAA 1.5V batteries (not supplied).

CODE	ALARM QUANTITY	RECEIVER QUANTITY	GENCOD	TRADE PACK	RRP (€)
HD4 ALARMS AND HD4R RECEIVER					
ACS490070	4	1		1	236.99
ACS490071	3	1		1	204.99
ACS490072	2	1		1	157.99

ALARM

HD3



- Our smallest most compact design bite alarm we've ever produced. This has been achieved by removing the traditional front speaker from the alarm, leaving the job of audible indication to the speaker on the wireless HD3R receiver.
- Adjustable 6 colour LED (Red, Green, Blue, Yellow, Purple & White), 20 second latching, 150m range, low battery warning, nightlight mode, power out socket for illuminated bobbins, superb reliability, long battery life and a quality ABS body.
- A digital rolling code system also allows extra alarms to be purchased separately and programmed to an existing receiver.
- Available as set of 4, 3, 2 (protection case included) or single.

HD3 x4 HD3R x1



HD3 x3 HD3R x1



HD3 x2 HD3R x1

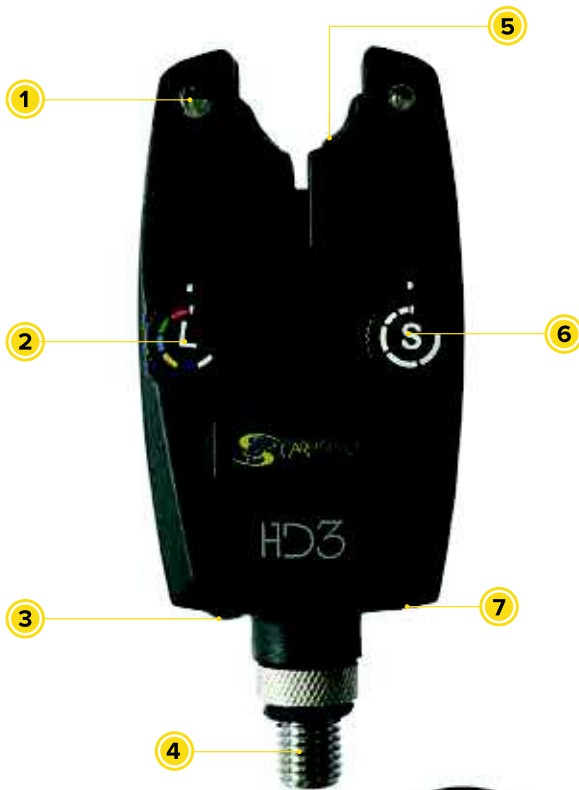

THE DETAIL

- 1 Ultra-bright long life LED.
- 2 LED colour control.
- 3 On/off power button.
- 4 Stainless steel screw thread.
- 5 Soft rubber non-slip insert.
- 6 Sensitivity control.
- 7 Power out socket.



HD3 Protective covers included.



THE DETAIL

- 1 On/off power / vibration switch.
- 2 LED Colour button.
- 3 LED Selection button.
- 4 Volume control.
- 5 Tone control.



HD3R table support and lanyard included.

Screw driver included.
Alarm uses 1x V23GA 12V Battery (not supplied). Receiver uses 1x 9V PP3 Battery (not supplied).

CODE	ALARM QUANTITY	RECEIVER QUANTITY	GENCOD	TRADE PACK	RRP (€)
HD3 ALARMS AND HD3R RECEIVER					
ACS490061	4	1		1	182.99
ACS490062	3	1		1	156.99
ACS490063	2	1		1	136.99

The new BLAX Bite Wireless Alarms and Receiver by Carp Spirit offer outstanding features, value and performance. With fully adjustable Tone, Volume, Sensitivity and a Night Light Facility, the BLAX Alarms have features normally reserved for high end alarms, additionally an LED colour change button allows the anglers to choose between 7 different LED colours all at press of a single button. Sleek and compact design, the body is made from tough and durable ABS body to ensure they will provide years of trouble free and reliable service.

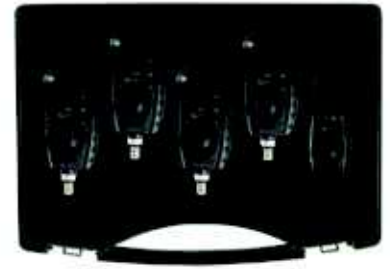

THE DETAIL

- ① Run and latching LED.
- ② Soft rubber non-slip insert.
- ③ Nightlight LED.
- ④ On / Off / volume.
- ⑤ Tone control.
- ⑥ Sensitivity control.
- ⑦ LED colour control.
- ⑧ Aluminium screw thread.



THE DETAIL

- ① On/off power.
- ② Volume control.
- ③ Tone control.
- ④ LED Colours x4.
- ⑤ Antenna.



9V battery for both Alarm and Receiver (not included).

CODE	QUANTITY	COLOUR	GENCOD	TRADE PACK	RRP (€)
BLAX ALARM & RECEIVER					
ACS490090	4+1	4		1	184.99

BLAX™ | VX-R**ALARM & RECEIVER**

BLAX V-XR Alarm Set (4+1)



- The wireless model in the BLAX alarm range. Built using the same high impact construction mould as the entry level version, the VX-R model includes all the standard features, with the added benefit of a wireless function and receiver.
- Features include Hi-Viz blue LED's, 4 volume settings, 4 tone settings, 4 levels of sensitivity, 20 second latching LED, nightlight mode, low battery warning, 2.5mm power out socket, 150m range, stainless steel screw thread, high impact ABS moulded construction.
- Available as a set of 4 or 3 (protection case included).

**THE DETAIL**

- ① On/off and 4 volume settings (plus silent mode).
- ② 4 tone settings.
- ③ 4 levels of sensitivity.
- ④ 20 second latching LED / Night light mode.
- ⑤ 2.5mm power out socket.
- ⑥ Stainless steel screw thread.
- ⑦ Soft rubber non-slip insert.

**THE DETAIL**

- ① On/off and 4 volume settings (plus silent mode).
- ② 4 tone settings.
- ③ Hi-Viz blue LED's.

Lanyard supplied for receiver.



9v battery for alarm (not supplied) / 3x AAA, 1.5v batteries for receiver (not supplied).

CODE	QUANTITY	COLOUR	GENCOD	TRADE PACK	RRP (€)
BLAX VX-R ALARM					
ACS490079	4+1	Blue		1	124.99
ACS490080	3+1	Blue		1	103.99

BLAX™ ALARM

- The BLAX entry level alarm is feature packed and outstanding value. Its compact design incorporates several features that are normally associated with more expensive bite alarms.
- Features include 4 volume settings, 4 tone settings, 4 levels of sensitivity, 20 second latching LED, nightlight mode, low battery warning, 2.5mm power out socket, stainless steel screw thread, high impact ABS moulded construction.
- Available as a set of 3 (red, yellow, green) or as a single alarm (blue).

BLAX Alarm Set (x3)



THE DETAIL

- 1 On/off and 4 volume settings (plus silent mode).
- 2 4 tone settings.
- 3 4 levels of sensitivity.
- 4 20 second latching LED / Night light mode.
- 5 2.5mm power out socket.
- 6 Stainless steel screw thread.
- 7 Soft rubber non-slip insert.

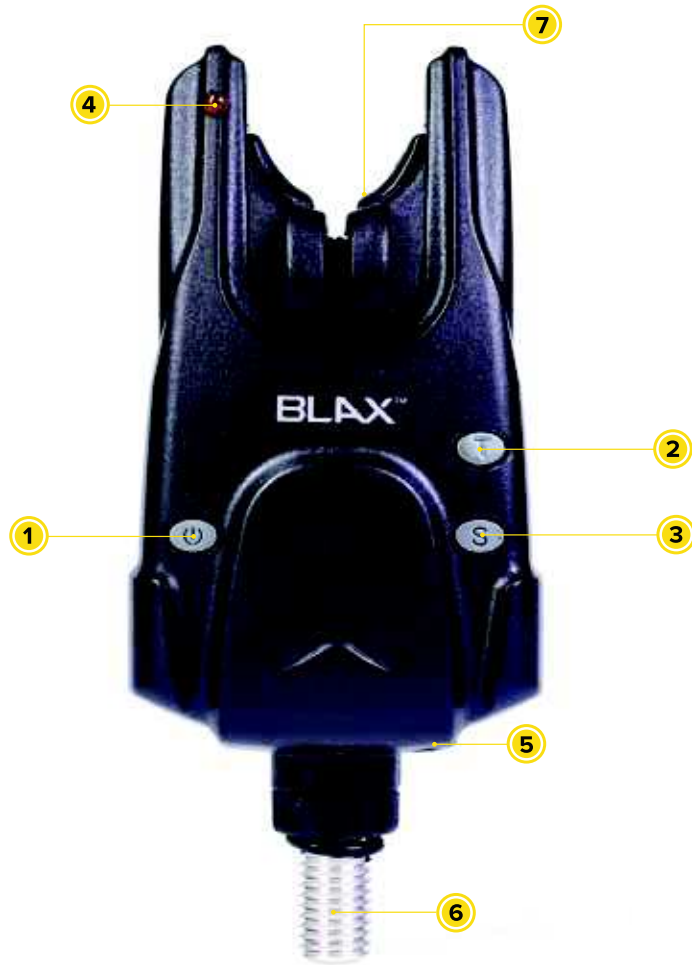

9v battery required (not supplied).

CODE	QUANTITY	COLOUR	GENCOD	TRADE PACK	RRP (€)
BLAX ALARM					
ACS490076	3	Red, Yellow, Green		1	57.99
ACS490077	1	Blue		1	19.99

BLUE ALARM + BATTERY

- Weatherproof.
- Volume control, ON/OFF switch.
- Jack for luminous hanger.
- Tone control.
- Reinforced screw.
- Delay LED for 20 seconds.
- Alarm requires 1 battery V23GA 12V (supplied).



CODE	QUANTITY	COLOUR	GENCOD	TRADE PACK	RRP (€)
BLUE ALARM					
ACC490016	1	Blue		1	10.49

ALARM SET

Suitable for carp and predator fishing.

Set includes:

- 2 aluminium bora point bank sticks (60/90).
- 1 blue alarm.
- 1 battery V23 GA.
- 1 U head rest.
- 1 chain hanger – blue.



CODE	QUANTITY	COLOUR	GENCOD	TRADE PACK	RRP (€)
ALARM SET					
ACC490020	1	Blue		1	34.99

SNAG EARS

- Prevents lost rods when fishing locked up.
- Made from lightweight Aluminium.
- Simple to install underneath the bite alarm so that the upright ears sit directly behind the alarm.
- Universal fittings to accommodate most makes and models of alarm.



CODE	COLOURS	QUANTITY	GENCOD	TRADE PACK	RRP (€)
SNAG EARS					
ACS370000	—	—		1	11.99



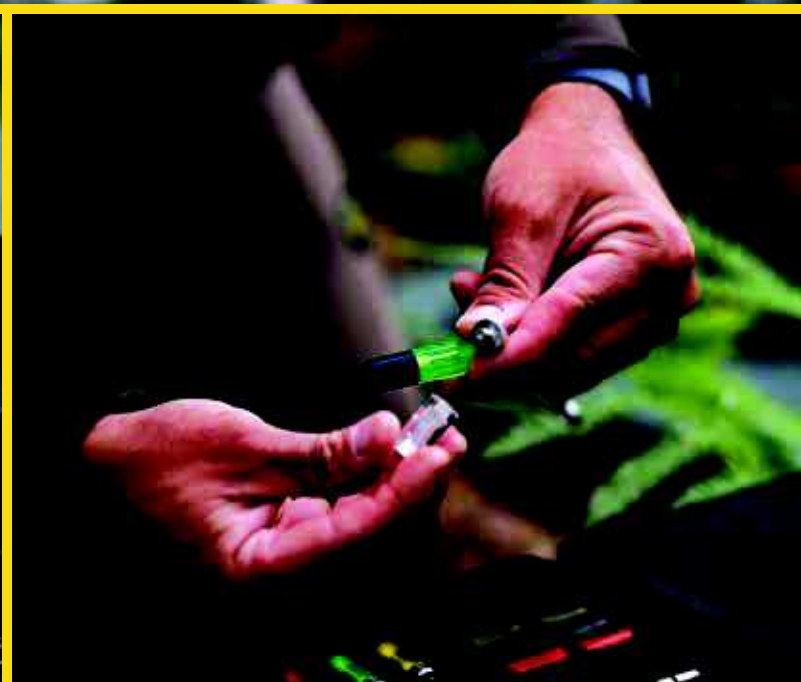

INOX BOBBINS

NEW 2025

The Carp Spirt INOX Bobbin system sets a new standard in visual bite indication. Not only do they look the part, each INOX Bobbin is packed with unique and clever features to offer enhanced bite indication, ease of use and versatility.

A key part to the INOX Bobbins versatility is the Duo Adjustable Clip (D.A.C.). The DAC allows the mainline to be fished either free running by simply passing the line between the magnetic balls or can be fished fixed by locating it into the lower second clip. Another clever feature is the addition of a side grub screw, which is used to directly adjust the tension between the magnetic balls, particularly useful when fishing braid or low diameter mainlines.

Set up is quick and simple thanks to the integrated Neo magnet and a keyed location slot in the hockey stick adaptor to ensure perfect alignment every time.

2x Screw in weights (5g & 10g) are included as standard, allowing the head to be fished at 0g, 5g, 10g & 15g configurations, covering everything from slack lining in the margins to tight lines at extreme range.

A dual axis pivot directly underneath the head further enhances the sensitivity of the swing arm; perfect for fishing slack lines and particularly useful for enhancing drop back indication.

6x LRA Heads (Light Reactive Acrylic) are included with each Bobbin in colours: Red, Green, Blue, Yellow, Purple & Clear, each featuring a hollow core to accept an isotope.

Hanger conversion kits available separately.

INOX Bobbins – Designed and developed in the UK.

- Duo Adjustable Clip (D.A.C.) – For Running line or fixed attachment
- Side grub screw – For increased tension when using Braid or low diameter lines.
- Integrated Neo Magnet – Rapid set up.
- Key location Hockey stick slot – Perfect alignment every time.
- 5g & 10g screw on weights included.
- Dual Axis head – Enhanced bite indication.
- Hollow head – Isotope can be added.
- 6x Colours – Red, Green, Blue, Yellow, Purple & Clear.



CODE	GENCOD	TRADE PACK	RRP (€)
INOX BOBBINS SET OF 4			
ACS490093		1	109.99
INOX BOBBINS SET OF 3			
ACS490092		1	84.99
INOX BOBBINS SET OF 1			
ACS490091		1	29.99

CHAIN HANGER

- Chain hanger complete with a high-vis body, adjustable metal line clip and removable Stainless Steel 12g weight.
- Choice of four different colour options – blue, red, green and yellow.

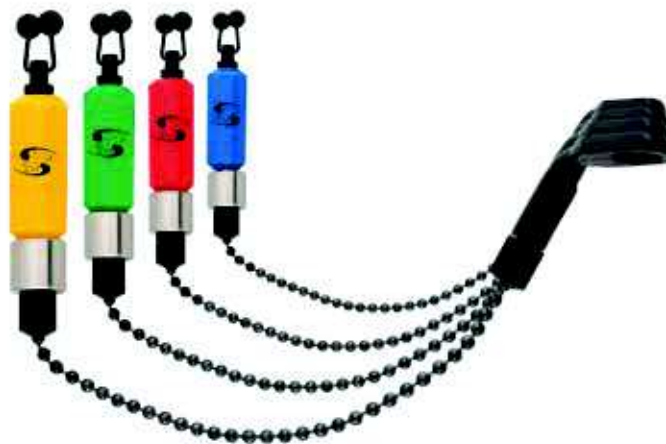

CODE	COLOURS	QUANTITY	GENCOD	TRADE PACK	RRP (€)
HANGER CHAIN					
ACS490082	● Blue	1		1	10.49
ACS490083	● Red	1		1	10.49
ACS490084	● Green	1		1	10.49
ACS490085	● Yellow	1		1	10.49

RIGID HANGERS

- Rigid hanger complete with a high-vis body, adjustable metal line clip, pivot arm and sliding Stainless Steel weight.
- Choice of four different colour options – blue, red, green and yellow.

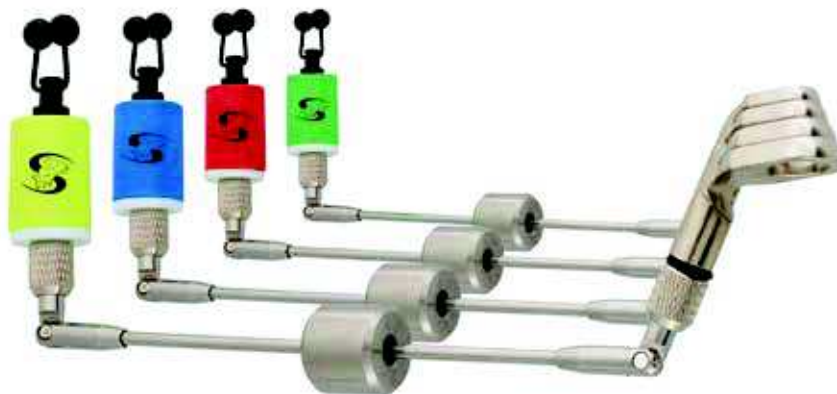

CODE	COLOURS	QUANTITY	GENCOD	TRADE PACK	RRP (€)
RIGID HANGERS					
ACS490086	● Blue	1		1	15.79
ACS490087	● Red	1		1	15.79
ACS490088	● Green	1		1	15.79
ACS490089	● Yellow	1		1	15.79

BANKWARE & PODS

CARP SPIRIT | BANKWARE
& PODS

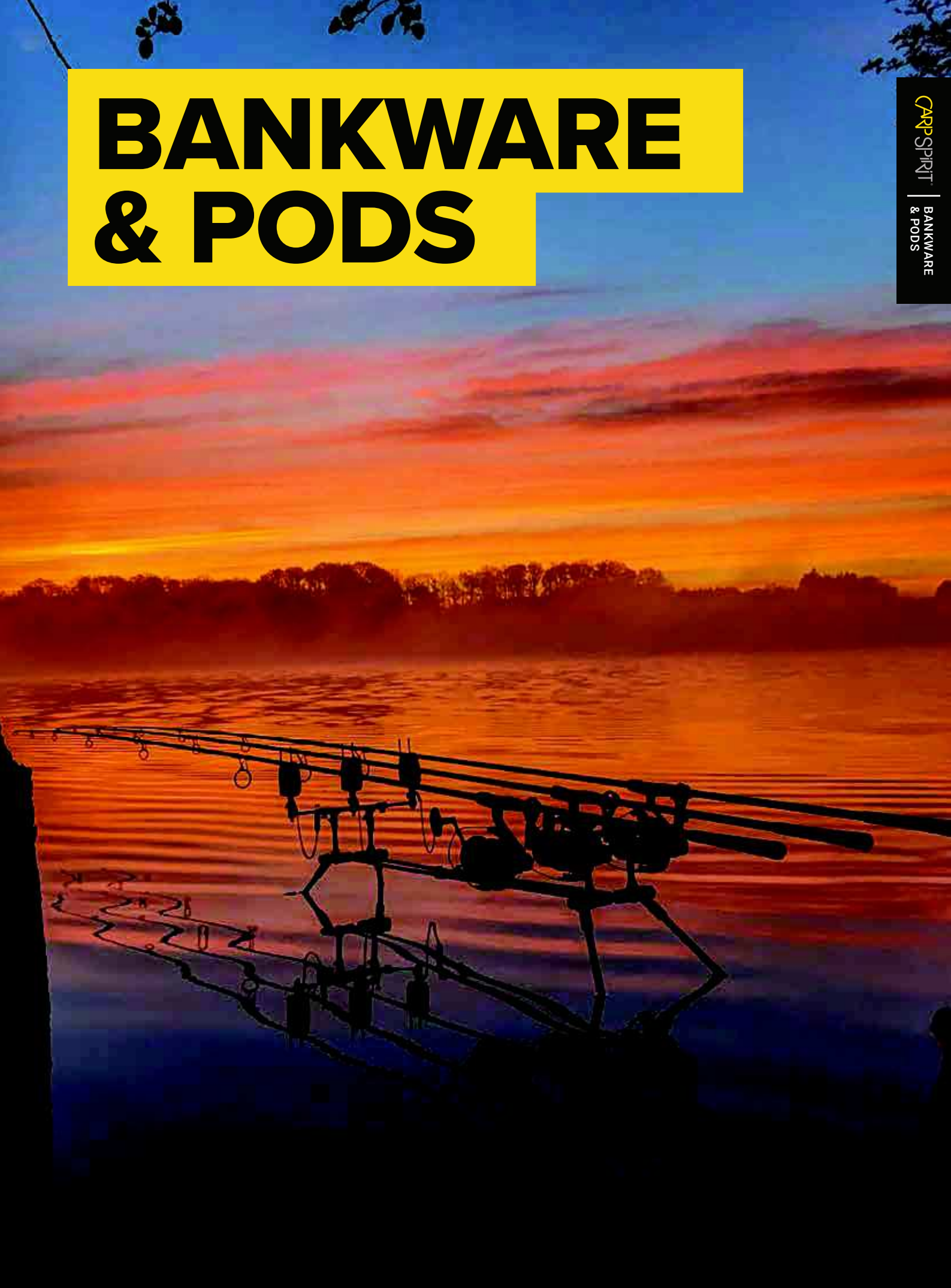

ROD PODS

INOX ROD POD

- Machined entirely from ultra-high grade 300 series stainless steel.
- Features unique 'dutch pin' spring lock system for rapid set and pack down.
- This innovative design allows the legs and uprights to be deployed and locked into place in just a matter of seconds.
- Designed to cope with all manner of surfaces and slopes, the legs can be locked into place at 90°, 45° or at a lower position of 22.5°.
- Each upright feature a quick release drop in adaptor to further aid quick set up and are compatible with all INOX buzz bars.
- Available as either a base only, or a 3 rod fixed option.



'Dutch Pin' spring lock system.



Pill system.

THE DETAIL

- 1 Unique spring lock bar system for rapid set up.
- 2 Legs can be set at 22.5, 45 or 90 degrees.
- 3 Long banksticks can be used for fishing 'rods up'.
- 4 No loss thumb screw design.
- 5 Machined from ultra-high grade 300 series stainless steel.
- 6 Hollow tube inserts for reduced weight.
- 7 Quick release drop in uprights designed to fit all INOX buzz bars.

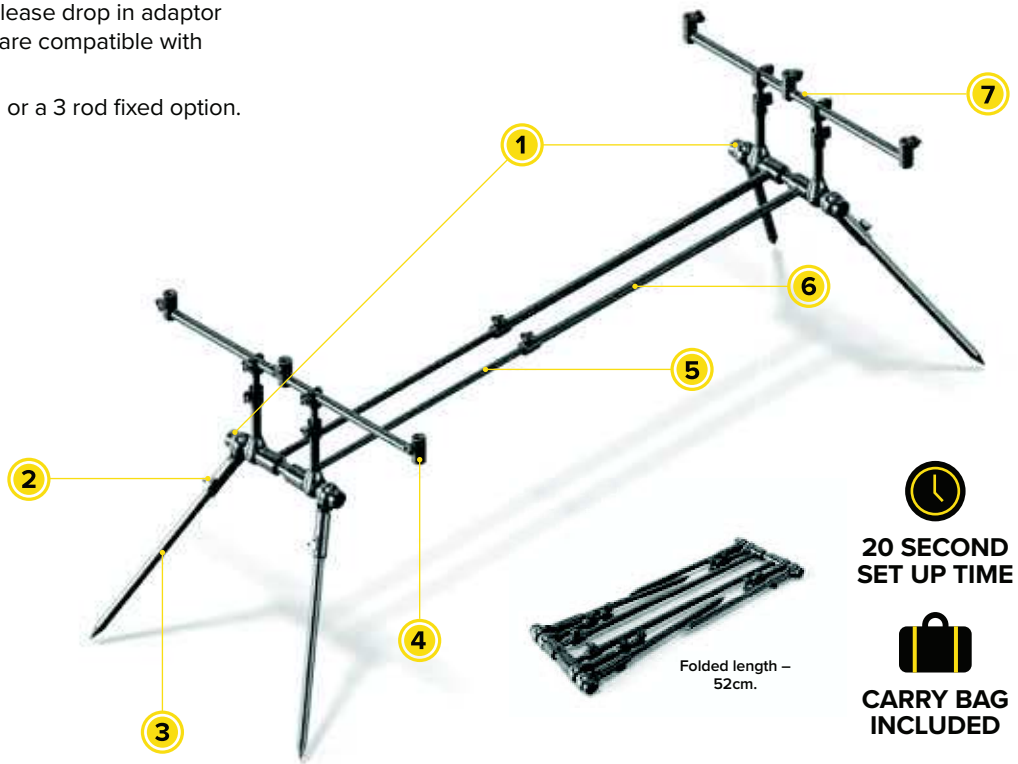

20 SECOND SET UP TIME





CARRY BAG INCLUDED

CODE	VERSION	WEIGHT (KG)	GENCOD	TRADE PACK	RRP (€)
INOX ROD POD					
ACS370094	Complete	4.13		1	439.99

GOLIATH ROD POD

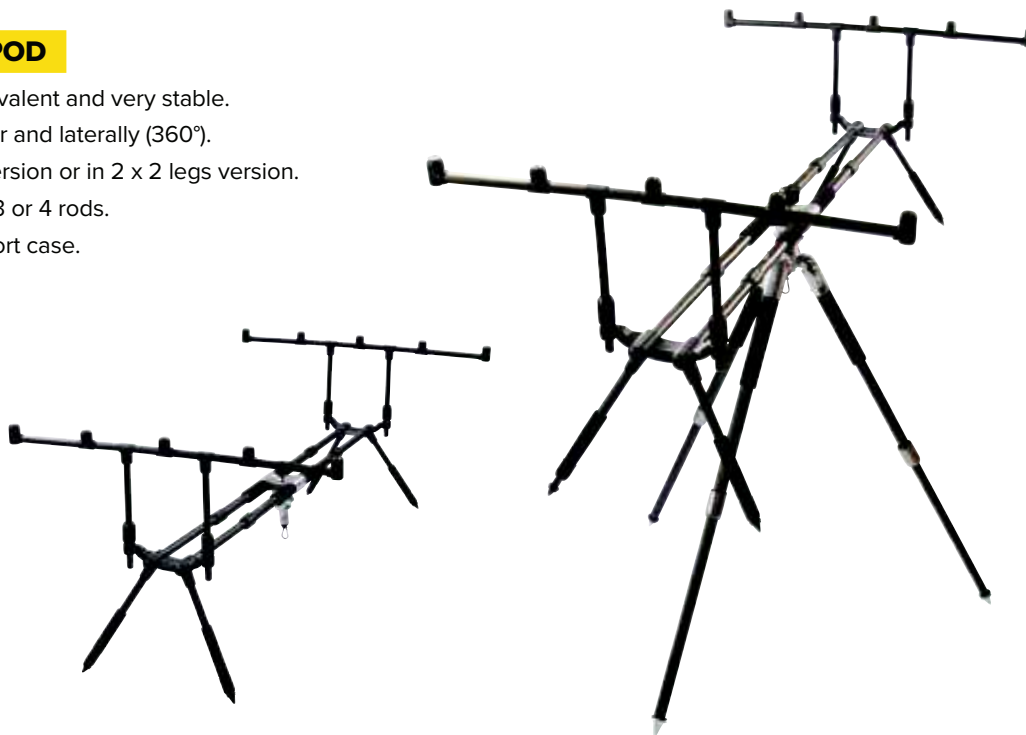
- Rod pod ultra polyvalent and very stable.
- Rotating front / rear and laterally (360°).
- Usable in tripod version or in 2 x 2 legs version.
- Usable in version 3 or 4 rods.
- Sold with a transport case.



CODE	LENGTH (CM)	HEIGHT (CM)	WEIGHT (KG)	GENCOD	TRADE PACK	RRP (€)
GOLIATH ROD POD						
ACS370114	160	40	5.5		1	261.99

BLAX™ ROD POD

- Manufactured from lightweight Aero Space grade 6063 Aluminium.
- Fully adjustable length and height; incredibly strong and stable.
- Additional pair of XL legs are included as standard so that rods can be fished pointing up in the air or for when fishing steep and sloping banks.
- Supplied with carry bag as standard.
- Durable Black Anodised finish.
- Available in 2/3 rod and 3/4 rod versions.



CODE	VERSION	WEIGHT (KG)	GENCOD	TRADE PACK	RRP (€)
BLAX ROD POD					
ACS370091	3/4 rod	4.0		1	188.99

BLAX ALU-LITE ROD POD

- Strong, stable & lightweight 6063 Aluminium construction.
- Matt black finish.
- Quick and easy Camlock adjustment.
- Compact folding design.
- 4x adjustable legs.
- Height adjustable uprights.
- Adjustable length 60cm – 100cm.
- Legs can be removed and used as Banksticks.
- Supplied in carry bag.



CODE	VERSION	WEIGHT (KG)	GENCOD	TRADE PACK	RRP (€)
BLAX ALU-LITE ROD POD					
ACS370115	4 rod	1.75		1	67.99
ACS370113	3 rod	1.70		1	63.99



BLAX ALU-LITE ROD POD BASE

- Strong, stable & lightweight 6063 Aluminium construction.
- Matt black finish.
- Quick and easy Camlock adjustment.
- Compact folding design.
- 4x adjustable legs.
- Height adjustable uprights.
- Adjustable length 60cm – 100cm.
- Legs can be removed and used as Banksticks.
- Supplied in carry bag.
- Weight 1.2kg.
- Accepts all BLAX Twin Thread Buzz Bars.*



*Can be combined perfectly with the BLAX Twin Thread Buzz Bars. Available separately, see below.

CODE	VERSION	DIMENSIONS (CM)	GENCOD	TRADE PACK	RRP (€)
BLAX ALU-LITE ROD POD BASE					
ACS370103	—	—		1	57.99

ROD POD SESSION

- Tilt forward / backward.
- 360° rotatable.
- Telescopic legs.
- Usable as 3 or 4 rod set up.
- Supplied with transport bag.



CODE	LENGTH (IN)	LENGTH (CM)	HEIGHT (CM)	WEIGHT (KG)	GENCOD	TRADE PACK	RRP (€)
ROD POD SESSION							
ACC370018	—	—	—	—		1	93.99

CARP SPIRIT ALU-LITE POD + BB 3 ROD ECO NEW 2025

- Aluminium construction.
- Matt black finish.
- Quick and easy Camlock adjustment.
- 4x adjustable legs.
- Legs can be removed and used as Banksticks.
- Supplied with carry bag.



CODE	VERSION	WEIGHT (KG)	GENCOD	TRADE PACK	RRP (€)
BLAX ALU-LITE POD + BB 3 ROD ECO					
ACS370117	3 rods	1.27		1	46.99

CARP SPIRIT MINI ROD POD NEW 2025

- Compact rod pod.
- Very light and great in small spaces.
- Ideal for stalking or short time fishing.
- 100% Aluminium.
- Supplied with carry bag.

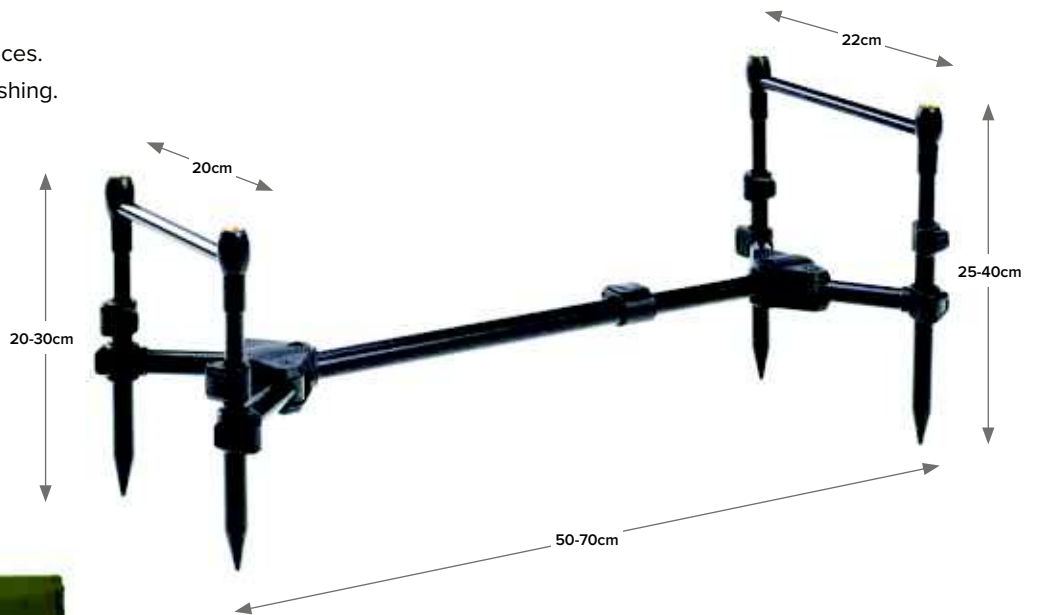

CODE	VERSION	WEIGHT (KG)	GENCOD	TRADE PACK	RRP (€)
MINI ROD POD					
ACS370118	2 rods	0.76		1	51.99

CARPSPIRIT 2/4 ROD SUPPORT SET

NEW 2025

- 2 / 4 rod support set, ideal for short sessions.
- 2 rod – Use as front and back support.
- 4 rod – Use as front support only.
- Transport bag included.



CARPSPIRIT | BANKWARE & PODS

CODE	WEIGHT (KG)	GENCOD	TRADE PACK	RRP (€)
2/4 ROD SUPPORT SET				
ACS370119	0.875		1	34.99



BANK STICKS



 DESIGNED AND DEVELOPED IN THE UK

- The Carp Spirit INOX 300 stainless steel range is the result of over 2 year's extensive design, development and testing.
- Designed completely from the ground up using CAD (Computer Aided Design) the extensive range covers a multitude of rod support set ups and is machined entirely from ultra-high grade 300 Series Stainless Steel.
- Made to last and provide years of trouble free service, innovative designs and features such as the quick release (QR) 'Pill' system have been introduced, along with some totally unique products such as the 2 in 1 deck stand and 'safe storage' bankstick stabilisers.
- Quality, Innovation and Design – The Carp Spirit INOX 300 Series.





BORA POINT BANKSTICKS

- Machined from ultrahigh grade 300 Series Stainless Steel and will provide years of trouble free use.
- Feature a quick release 'Pill' system which allows alarms to be quickly removed or butt rests to be changed in seconds.
- The 'Bora Point' design is perfect for drilling the banksticks into hard ground.
- No Loss Tri-lobe thumb screw design.
- Hollow tube inserts for reduced weight.
- Pointed inserts double up as stalking sticks.
- 3/8" BSF Thread.
- Compatible with the 2 in 1 key (sold separately).

CODE	LENGTH (IN)	LENGTH (CM)	WEIGHT (KG)	GENCOD	TRADE PACK	RRP (€)
QR BORA POINT BANKSTICKS						
ACS370032	16	40/66	305		1	39.99
ACS370031	12	30/46	250		1	36.99

BLAX STORM POLES

- Strong and lightweight – 16 / 19mm Aluminium construction.
- Matt black finish.
- Toughened screw point ends.
- Capped inner tubes to prevent dirt ingress.
- T-bar included for extra turning power.
- Quick and easy Camlock adjustment.



CODE	LENGTH (IN)	LENGTH (CM)	HEIGHT (CM)	WEIGHT (KG)	GENCOD	TRADE PACK	RRP (€)
BLAX STORM POLES							
ACS370102	—	—	100–180	—		1	13.19
ACS370100	—	—	75–130	—		1	10.49
ACS370099	—	—	55–90	—		1	9.45
ACS370101	—	—	40–60	—		1	6.99

BUZZ BARS



BUZZ BARS

- Machined from ultrahigh grade 300 Series Stainless Steel and will provide years of trouble free use.
- Feature a quick release 'Pill' system which allows alarms to be quickly removed or butt rests to be changed in seconds.
- The 2 & 3 rod versions feature three male 3/8" BSF threads allowing them to be used with either single banksticks or in a 'goal post' style set up with bank sticks at either end.
- No Loss Tri-lobe thumb screw design.
- Hollow tube inserts for reduced weight.
- 3/8" BSF Thread.
- Compatible with the 2 in 1 key (sold separately).



2/3 RODS ADJUSTABLE BUZZ BAR

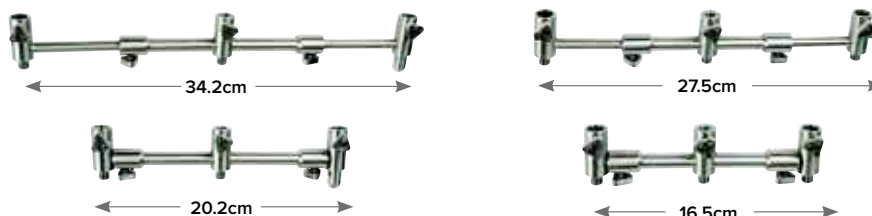

CODE	RODS	LENGTH (CM)	WEIGHT (G)	GENCOD	TRADE PACK	RRP (€)
2/3 RODS ADJUSTABLE BUZZ BAR						
ACS370034 (Front)	2/3	20.2 – 34.2	375		1	52.49
ACS370051 (Rear)	2/3	16.5 – 27.5	355		1	52.49

2 RODS FIXED BUZZ BAR



CODE	RODS	LENGTH (CM)	WEIGHT (G)	GENCOD	TRADE PACK	RRP (€)
2 RODS FIXED BUZZ BAR						
ACS370035 (Front)	2	22.5	245		1	31.49
ACS370052 (Rear)	2	20.0	235		1	31.49

3 RODS FIXED BUZZ BAR



CODE	RODS	LENGTH (CM)	WEIGHT (G)	GENCOD	TRADE PACK	RRP (€)
3 RODS FIXED BUZZ BAR						
ACS370036 (Front)	3	39.0	310		1	41.99
ACS370053 (Rear)	3	33.0	295		1	41.99



INOX 300
STAINLESS STEEL

QR PILL PACK

- The pill adaptor simply screws into the top of any bankstick or buzz bar to convert it into a quick release system.



(key not included).

CODE	QUANTITY (PER PACK)	COLOUR	WEIGHT (G)	GENCOD	TRADE PACK	RRP (€)
QR PILL PACK						
ACS370043	2	—	—		1	8.39

INOX 300
STAINLESS STEEL

2 IN 1 KEY TOOL

- Perfect for tightening and or unscrewing our anti-loss screws.



CODE	QUANTITY (PER PACK)	COLOUR	WEIGHT (G)	GENCOD	TRADE PACK	RRP (€)
2 IN 1 KEY TOOL						
ACS370042	1	—	—		1	6.29

BLAX TWIN THREAD BUZZ BARS

- Lightweight 6063 Aluminium.
- Matt black finish.
- Twin thread design with moulded threads.
- Can be used with Banksticks for a goal post set up.
- Compatible with BLAX Alu-Lite Pod Base.
- Sold in pairs (front & rear).

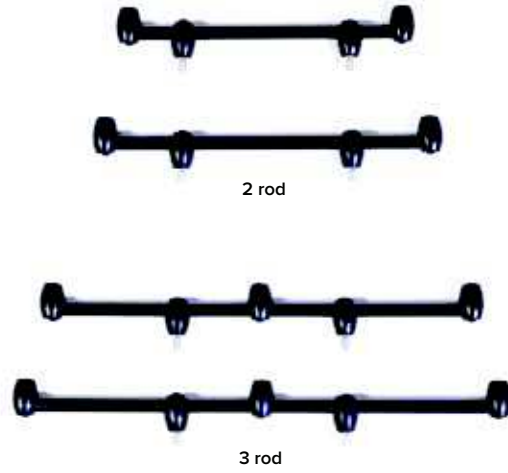

CODE	VERSION	DIMENSIONS (CM)	GENCOD	TRADE PACK	RRP (€)
BLAX TWIN THREAD BUZZ BARS					
ACS370104	2 Rod	Front - 30.5cm / Rear - 28cm		1	14.59
ACS370105	3 Rod	Front - 44cm / Rear - 40.5cm		1	17.79

BLAX BUZZ BAR x2

- Lightweight 6063 Aluminium.
- Matt black finish.
- Moulded threads.
- Can be used with Banksticks for a goal post set up.
- Sold in pairs (front & rear).



CODE	VERSION	LENGTH (CM)	GENCOD	TRADE PACK	RRP (€)
BLAX BUZZ BAR					
ACS370111	2 Rod	31cm		1	13.49
ACS370112	3 Rod	44cm		1	15.59

BLAX ANGLE ADAPTOR

- Perfect for fishing steep and sloping banks to ensure that the bite alarm and rod rests are at 90 degree to the rod.
- Simply set the desired angle and lock in place at the turn of a screw.



CODE	SIZE	LENGTH (CM)	WEIGHT (G)	GENCOD	TRADE PACK	RRP (€)
BLAX ANGLE ADAPTOR						
ACS370086	—	—	—		1	15.99

BLAX PILL ADAPTOR

- An ideal upgrade for anglers who already own Carp Spirit BLAX bank ware range.
- The BLAX pill adaptor simply screws into the top of any bankstick or buzz bar to convert it into a quick release system.



CODE	SIZE	LENGTH (CM)	WEIGHT (G)	GENCOD	TRADE PACK	RRP (€)
BLAX PILL ADAPTOR						
ACS370087	—	—	—		1	13.99



LUCA HEUER

@luca_hh_offishal

ROD RESTS

LOCKING BUTT GRIP

- Clamp down design – securely locks rods into place.
- Automatically releases when rod is lifted.
- Anti-slip moulded inserts.
- Will accept rods up to 22mm (standard) and 16mm (small) diameter.
- 3/8 BSF stainless steel thread.
- Black alignment collar and rubber washer included.



CODE	QUANTITY (PER PACK)	COLOUR	WEIGHT (G)	GENCOD	TRADE PACK	RRP (€)
LOCKING BUTT GRIP						
ACS370107	1	Black	—		5	10.49
<small>NEW 2025</small> ACS370120 (S)	1	Black	—		5	8.99

STAINLESS STEEL ADJUSTABLE HEAD

- Easily adjustable support thanks to the two systems of lateral and lower screws.
- It will perfectly support your rod, either in 10, 12 or 13 feet, thanks to a precise adjustment of the spacing of the supporting lamellae.
- The lamellae are even topped with a “soft touch” grip in order to avoid any slipping of the rod and to protect the butt section.
- The whole support is made with corrosion resistant materials for a longer durability.



CODE	QUANTITY (PER PACK)	COLOUR	WEIGHT (G)	GENCOD	TRADE PACK	RRP (€)
STAINLESS STEEL ADJUSTABLE HEAD						
ACS370020	1	—	—		3	15.69

QUICK RELEASE ADAPTOR

- Instant pull back release.
- Strong and secure.
- Multitude of uses.



CODE	QUANTITY (PER PACK)	COLOUR	WEIGHT (G)	GENCOD	TRADE PACK	RRP (€)
QUICK RELEASE ADAPTOR						
ACS370012	1	—	—		3	7.29

BUTT RESTS

- Strong, flexible moulded Nylon.
- Ideal for rod butts up to 22mm diameter (Slim), or 26mm diameter (Standard).
- 3/8 BSF thread.
- Black alignment collar and rubber washer included.
- Available in standard or slim sizes.



CODE	QUANTITY (PER PACK)	COLOUR	WEIGHT (G)	GENCOD	TRADE PACK	RRP (€)
BUTT RESTS						
ACS370109 (Standard)	1	Black	—		5	5.79
ACS370108 (Slim)	1	Black	—		5	5.79

SOFT HEAD

- Clamp down design – securely locks rods into place.
- Automatically releases when rod is lifted.
- Anti-slip moulded inserts.
- Will accept rods up to 22mm diameter.
- 3/8 BSF stainless steel thread.
- Black alignment collar and rubber washer included.



CODE	QUANTITY (PER PACK)	COLOUR	WEIGHT (G)	GENCOD	TRADE PACK	RRP (€)
SOFT HEAD						
ACC370023	1	Black	—		10	3.85
ACC370024	1	Luminous	—		10	3.85

ROD RESTS

- U-head for the back of the rod and V head for the front with space for nylon or braid.
- Thread 3/8.



CODE	QUANTITY (PER PACK)	COLOUR	WEIGHT (G)	GENCOD	TRADE PACK	RRP (€)
ROD RESTS						
143100360 (U)	1	Black	—		10	2.09
143200360 (V)	1	Black	—		10	2.09



RODS



ROD SPECIFICATION

Product	Modulus	NMC Carbon	ASF Finish	Anti-Frap Tip Guide
MAGNUM XLR 828	46-Ton	●	●	●
MAGNUM X5 829	40-Ton	●	●	●
MAGNUM X3 830	36-Ton	●	●	●
MAGNUM X2 832	30-Ton	—	—	●
MAGNUM X2 SPOD 832	30-Ton	—	—	●
MAGNUM X2 Cork 833	30-Ton	—	—	●
BLAX Evo Modulus 834 <small>NEW 2025</small>	24-Ton	—	—	—
BLAX Spod Evo 835 <small>NEW 2025</small>	30-Ton	—	—	—

NANO MATRIX CARBON

Our multi walled Nano-Matrix Carbon blanks are so strong because they are made up of a single chain of unbroken covalent carbon to carbon bonds within the low resin pre-preg; the end result is slimmer, lighter and higher performance rod blanks.

This process is reserved exclusively for our top of the range Magnum rods XLR, X5 and X3 series.

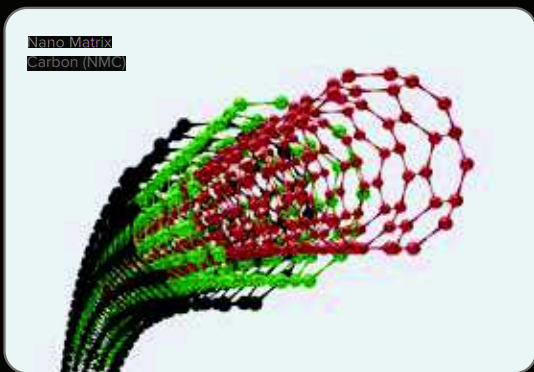

ANTI-SCRATCH FINISH

All blanks that feature ASF are precision laser ground to ultra-high tolerances.

This removes the traditional requirement to apply paint or varnish to the blank, and is therefore the final process before any components are fitted.

The end result is a smooth, long lasting and durable surface finish, which will ensure that your rods will still look as good as the day that you bought them, even after many years of use.

STAINLESS STEEL BUTT CAP

Manufactured from 300 series grade stainless steel with a laser etched Logo. The hard nature of stainless steel is more durable and resistant to damage.

ANTI-FRAP TIP GUIDES

Anti-Frap tip guides feature smooth and blended side bracings between the tube and centre frame. This special shape greatly reduces the chances of line getting wrapped around the tip of the blank before, during or after the cast.

FUJI BKWAG GUIDES

Highest quality, tangle free, Japanese rod guides with lightweight Alconite centres. The special smooth shape of the frame makes them perfect for extreme distance casting and when heavy duty shock leaders are required.

Guide Model	Guide Type	Butt Cap	Colour Guide	Reel Seat	Handle
Fiji Alconite BKWAG	Double Leg	SS	Black	ALPS	Abbreviated
Sea-Guide TUXTLG + XUT	Double Leg	SS	Gunsmoke	18mm DPS Fuji	Abbreviated
Sea-Guide TUXTLG + XUT	Double Leg	SS	Gunsmoke	18mm DPS	Abbreviated
Sea-Guide SGT	Double Leg	Aluminium	Gunsmoke	18mm DPS	Abbreviated
Sea-Guide SGT	Double Leg	Aluminium	Gunsmoke	18mm DPS	Full shrink
Sea-Guide SGT	Double Leg	Aluminium	Gunsmoke	18mm DPS	Cork
Slim Guides Mat	Double Leg	Aluminium	Black	18mm DPS	Full shrink
Slim Guides Mat	Double Leg	Aluminium	Black	18mm DPS	Abbreviated

SEA-GUIDE GUIDES



TUXTLG – Highest quality, lightweight, double leg guides with a Titanium finished frame. Featuring Silicon Carbide centres and externally rolled frames to help prevent guide centre damage.

BTLTSG – High quality, lightweight, double leg guides with a black anodised finish. Featuring Silicon Carbide centres and externally rolled frames to help prevent guide centre damage.

BTLSG – High quality, lightweight, double leg guides with a black anodised finish. Featuring Silicon Carbide centres and externally rolled frames to help prevent guide centre damage.

CARBON CLONE REEL SEAT



Machined entirely from a carbon tube and featuring a 1K weave, this reel seat is ultra light weight and perfectly matches the rod weave and cosmetics. It will accept both big pit and standard size reels.

FUJI DPS REEL SEAT



High quality Japanese moulded reel seat that is both secure and comfortable. Will accept both big pit and standard size reels.

ALPS REEL SEAT



Highest quality, light weight and incredibly strong. The ALPS reel seat is machined entirely from aerospace grade Aluminium and anodised in black.

The dual collars and nylon lock washer provide an incredibly strong and secure fixing for even the largest of big pit reels. Perfect for withstanding the torque and turning forces generated during extreme distance casting.

1-K WEAVE



The tightest weave we use on our rods. The multi-directional carbon fibres are interwoven at a rate of 1mm x 1mm, providing thousands of overlays across the blank length.

The end result is added strength to the blank itself and increased tip speed recovery to aid both casting distance and accuracy.

3-K WEAVE



Multi-directional carbon fibres are interwoven at a rate of 3mm x 3mm, providing thousands of overlays across the blank length.

The end result is added strength to the blank itself, and increased tip speed recovery to aid both distance casting and accuracy.



MAGNUM[®] XLR

MAGNUM XLR

- A rod like no other! XLR means Xtra-Long Range, and that is exactly the sole purpose of this rod. To deliver baits and PVA bags to the horizon.
- Made from Hi-Modulus Nano Matrix 46-ton carbon and wrapped in a 1K weave along its full length.
- Key to achieving these kinds of distances is the specially tapered butt section. So fast is the taper that the XLR will easily cope with leads up to 6oz in weight.
- Of course, pushing rods like this to the limit demands the highest performance fittings. That's why we chose a CNC machined Alps reel seat for maximum reel security, and Fuji BKWAG to cope with the fast line speed and heavy duty shock leaders required for such a specialist tool.



NANO MATRIX CARBON

Stronger, lighter, Higher Performance Blanks.



ANTI-SCRATCH FINISH

Ensures your rods look great after years of use.



ANTI-FRAP TIP GUIDE

Reduces line wrapping around the tip.



FUJI ALCONITE BKWAG GUIDES

Highest quality Fuji DPS gunsmoke reel seat.



STAINLESS STEEL BUTT CAP

Featuring laser etched logo.



ALPS REEL SEAT

Highest quality, lightweight and incredibly strong.



1-K WEAVE

For added strength and increased tip speed recovery.

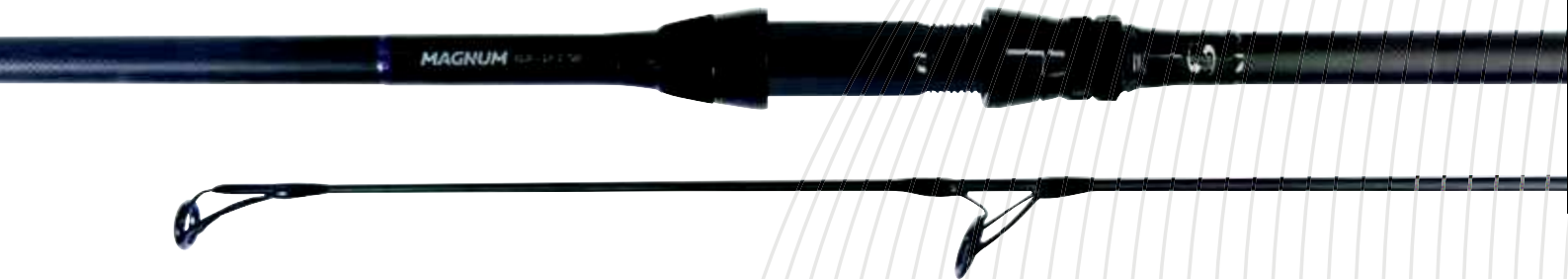

CODE	LENGTH (FT/M)	TEST CURVE (LB)	GUIDE SIZES	OPT. CAST WEIGHT	GENCOD	TRADE PACK	RRP (€)
MAGNUM XLR							
ACS170001	13/3.96	3.75	50-40-30-25-20 +16T	120-170g		1	399.99



MAGNUM[®] X5

MAGNUM X5

- Our top of the range Magnum X5 rods are all manufactured from 40-Ton High Modulus Nano Matrix Carbon (NMC), which gives the blanks their ultra slim diameter yet still provides plenty of power in reserve.
- All the Magnum Series rods feature the same semi fast action, which, after extensive testing by the Pro team was found to be the perfect balance between being able to cast leads to extreme distances yet still retain a tip soft enough to absorb the lunges of the fish during key stages of the fight.
- Built using only the highest quality fittings including a carbon clone reel seat and an ASF technology blank, the Magnum X5 series are without doubt the ultimate carp fishing rods available today.



NANO MATRIX CARBON – NMC
Stronger, lighter, Higher Performance Blanks.



ANTI-SCRATCH FINISH
Ensures your rods look great after years of use.



ANTI-FRAP TIP GUIDE
Reduces line wrapping around the tip.



SEA-GUIDE TUXTLSG GUIDES
Highest quality Titanium finish SIC double leg guides.



STAINLESS STEEL BUTT CAP
Featuring laser etched logo.



CARBON CLONE REEL SEAT – 18MM
Ultra lightweight and machined from carbon tube.



1-K WEAVE
For added strength and increased tip speed recovery.



CODE	LENGTH (FT/M)	TEST CURVE (LB)	GUIDE SIZES	OPT. CAST WEIGHT	GENCOD	TRADE PACK	RRP (€)
MAGNUM X5							
ACS170002	13/3.96	3.50	50-40-30-25-20 +16T	100-160g		1	324.99
ACS170003	12/3.66	3.50	50-40-30-25-20 +16T	90-140g		1	309.99
ACS170028	10/3.05	3.00	40-30-25-20-26 +16T	60-100g		1	249.99



OUR MOST
VERSATILE
ROD





MAGNUM[®] X3

MAGNUM X3

- Manufactured from 36-Ton Hi-Modulus Nano Matrix Carbon (NMC) the Magnum X3 range is a series of rods with a semi fast action that offer fantastic performance.
- The butt section holds plenty of power in reserve for casting heavy leads and PVA bags, yet the tip section is still forgiving enough to absorb the lunges during a fight.
- The high-quality Fuji reel seat is compatible with both big pit and standard size reels, and the ASF technology blanks finished in a 3K weave ensure that the Magnum X3 Series will be a firm favourite.
- Available in a range of lengths and text curves.

-  **NANO MATRIX CARBON**
Stronger, lighter, Higher Performance Blanks.
-  **ANTI-SCRATCH FINISH**
Ensures your rods look great after years of use.
-  **ANTI-FRAP TIP GUIDE**
Reduces line wrapping around the tip.
-  **SEA-GUIDE TUXTLG GUIDES**
Highest quality Titanium finish SIC double leg guides.
-  **STAINLESS STEEL BUTT CAP**
Featuring laser etched logo.
-  **CARBON CLONE REEL SEAT – 18MM**
Ultra lightweight and machined from carbon tube.
-  **3-K WEAVE**
For added strength and increased tip speed recovery.



CODE	LENGTH (FT/M)	TEST CURVE (LB)	GUIDE SIZES	OPT. CAST WEIGHT	GENCOD	TRADE PACK	RRP (€)
MAGNUM X3							
ACS170005	13/3.96	3.50	50-40-30-25-20 +16T	100-160g		1	239.99
ACS170006	12/3.66	3.50	50-40-30-25-20 +16T	90-140g		1	229.99
ACS170007	12/3.66	3.00	50-40-30-25-20 +16T	80-120g		1	219.99
ACS170030	10/3.05	3.50	40-30-25-20-16 +16T	80-120g		1	189.99
ACS170027	10/3.05	3.00	40-30-25-20-16 +16T	60-100g		1	174.99





MAGNUM X2

- An extensive series of rods with fantastic performance and value.
- The blank made by using a special 30-Ton hi-modulus carbon offering a slim blank, fast action and lightweight.
- Cosmetics are both minimalistic and subtle with matte finished blanks, gunsmoke reel seats and guide frames, and with a small section of 3K weave above the reel seat.
- High quality SEA GUIDE TDG guides are used throughout, which are lighter, provide increased transmission and are not damaged from braid use when compared with ceramic guides.



CODE	LENGTH (FT/M)	TEST CURVE (LB)	GUIDE SIZES	OPT. CAST WEIGHT	GENCOD	TRADE PACK	RRP (€)
MAGNUM X2							
ACS170031	13/3.96	3.50	50-40-30-25-20 +16T	100-160g		1	155.99
ACS170032	12/3.66	3.50	50-40-30-25-20 +16T	90-140g		1	145.99
ACS170033	12/3.66	3.00	50-40-30-25-20 +16T	80-120g		1	134.99
ACS170034	10/3.05	3.50	40-30-25-20-16 +16T	80-120g		1	124.99
ACS170039	10/3.05	3.00	40-30-25-20-16 +16T	60-100g		1	114.99
MAGNUM X2 SPOD							
ACS170048	13/3.96	5.00	50-40-30-25-20 +16T	160-240g		1	159.99
ACS170035	12/3.66	5.00	50-40-30-25-20 +16T	160-240g		1	145.99



MAGNUM[®] X2

MAGNUM X2 CORK



ANTI-FRAP TIP GUIDE

Reduces line wrapping around the tip.



SEA-GUIDE SGT GUIDES

High quality Black finish SIC double leg guides.



ALUMINIUM BUTT CAP

Featuring laser etched logo.



18MM DPS REEL SEAT



MATT FINISH BLANK



CODE	LENGTH (FT/M)	TEST CURVE (LB)	GUIDE SIZES	OPT. CAST WEIGHT	GENCOD	TRADE PACK	RRP (€)
MAGNUM X2 CORK EDITION							
ACS170036	12/3.66	3.00	50-40-30-25-20 +16T	80-120g		1	134.99
ACS170037	10/3.05	3.50	40-30-25-20-16 +16T	80-120g		1	124.99
ACS170040	10/3.05	3.00	40-30-25-20-16 +16T	60-100g		1	114.99



BLAX™

BLAX EVO NEW 2025

- A series of rods that have been designed and developed to be 'best in class'.
- At first glance you would be forgiven for thinking that the BLAX rods are twice their actual price and rightly so.
- Slim, lightweight, dark matte blanks have been constructed using the finest 24-Ton carbon pre-preg.
- Built using high quality Slim Guides and lightweight anodised Aluminium fittings.
- Amongst the standard test curves, you will find some fantastic utility rods such as the 10ft rod, ideal for stalking or for use in tight swims.



ANTI-FRAP TIP GUIDE
Reduces line wrapping around the tip.



SLIM GUIDES
High quality Black slim double leg guides.



ALUMINIUM BUTT CAP
Featuring laser etched logo.



18MM DPS REEL SEAT



MATT FINISH BLANK



CODE	LENGTH (FT/M)	TEST CURVE (LB)	GUIDE SIZES	REC. CAST WEIGHT	GENCOD	TRADE PACK	RRP (€)
BLAX EVO							
ACS170044	13/3.96	3.50	50-40-30-25-20 +16T	100-160g		1	79.99
ACS170045	12/3.66	3.50	50-40-30-25-20 +16T	90-140g		1	74.99
ACS170046	10/3.05	3.50	40-30-25-20-16 +16T	80-120g		1	62.99



BLAX™

BLAX™ EVO SPOD NEW 2025

Spod rods are a key part of any carp angler's armoury and our BLAX spod rod is well up to the job Powerful but progressive action, with huge power reserves in the butt section.



CODE	LENGTH (FT/M)	TEST CURVE (LB)	GUIDE SIZES	REC. CAST WEIGHT	GENCOD	TRADE PACK	RRP (€)
BLAX EVO SPOD							
ACS170047	12/3.66	5.00	50-40-30-25-20 +16T	160-240g		1	79.99



LANDING NETS



MAGNUM MULTI NET NEW 2025

- The Magnum Multi Net has stunning looks and fantastic performance.
- 42"/105cm Super strong carbon arms.
- Supplied EVA arm floats.
- Lightweight moulded carbon spreader block.
- Hi-modulus lightweight carbon handle in 3 sections. 180 / 3.
- Yellow EVA end cap to protect each section.
- Anti-slip shrink wrap handle.
- Anodised Aluminium laser etched butt cap.
- Super soft, fish friendly, green mesh.
- Mesh clip-up magnet – helps prevent mesh snagging on the bottom.
- Supplied with carry case.

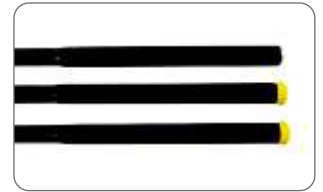
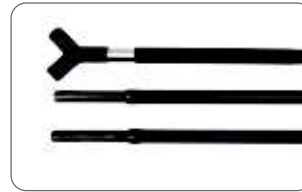
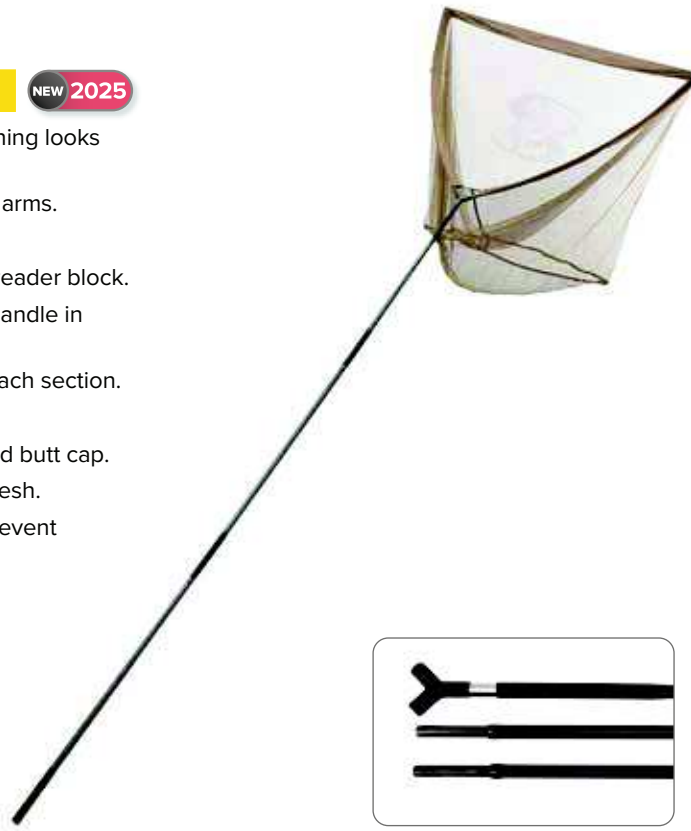

CODE	DIMENSIONS (IN)	DIMENSIONS (CM)	GENCOD	TRADE PACK	RRP (€)
MAGNUM MULTI NET					
ACS180028	42 x 42	105 x 105		1	129.99

BLAX MULTI NET NEW 2025

- The BLAX MULTI Net has been designed and developed to offer both excellent value and performance.
- 42"/105cm Super strong arms with aluminium end protectors.
- Supplied EVA arm floats.
- Moulded nylon spreader block.
- Lightweight carbon handle in 2 sections. 180 / 2
- Yellow EVA end cap to protect each section.
- Anti-slip shrink wrap handle.
- Anodised Aluminium laser etched butt cap.
- Super soft fish friendly green mesh.
- Mesh clip-up magnet – helps prevent mesh snagging on the bottom
- Supplied with carry case.



CODE	DIMENSIONS (IN)	DIMENSIONS (CM)	GENCOD	TRADE PACK	RRP (€)
BLAX MULTI NET					
ACS180029	42 x 42	105 x 105		1	79.99

BLAX 42" / 105CM X-NET

- Outstanding value Landing Net.
- Lightweight 6ft – 180cm Carbon Composite handle.
- 1-piece moulded spreader block.
- Medium depth fish friendly mesh.
- Matt finish handle with minimalist graphics.



CODE	DIMENSIONS (IN)	DIMENSIONS (CM)	GENCOD	TRADE PACK	RRP (€)
BLAX 42" / 105CM X-NET					
ACS490078	42 x 42	105 x 105		1	52.99

CARPSPIRIT CARP LANDING NET

- Fibreglass handle and arm.
- Nylon block.
- Nylon end arms.
- Thin mesh with mesh protection along the arms.



CODE	DIMENSIONS (IN)	DIMENSIONS (CM)	GENCOD	TRADE PACK	RRP (€)
CARP LANDING NET					
ACS180027	—	180(L) x 100(W) x 80(D)		1	26.49

CARPSPIRIT FAST CARP NET NEW 2025

- The 'FAST CARP NET' is equipped with a telescopic handle and rigid aluminium frame. This large version will allow you to deal with all situations even on the largest carp.
- Ideal for competition fishing when speed of netting is important.
- Rigid frame is perfect when extracting fish from weed beds.
- Extremely strong construction.
- High-quality rubber mesh net helps protect the fish.
- Ultra-fast interlocking and clip locking.
- Telescopic Aluminium handle: 90-160cm.
- Aluminium head: 90 x 70cm.
- Rubber mesh net depth: 70cm.



CODE	DIMENSIONS (CM)	GENCOD	TRADE PACK	RRP (€)
FAST CARP NET				
ACS180030	180-250 x 70 x 70		1	49.99

BLAX BOAT & WEED NET NEW 2025

This spoon-shaped carp landing net was not only developed for special use in weedy waters, but also for safely landing fish in reeds or water lilies. Conventional carp landing nets reach their limits in such conditions due to their design. The shape of the rigid frame allows you to push the weeds or plants aside, pierce the weeds or reeds to land the fish quickly and safely.

- The landing net for weed, reeds and water lilies.
- Spoon-shaped design.
- Rigid aluminum frame.
- Super soft, fish friendly, tight mesh green net.
- Excellent value for money.
- Dimensions: 82cm x 66cm x 100cm (net depth).



CODE	DIMENSIONS (CM)	GENCOD	TRADE PACK	RRP (€)
BLAX BOAT & WEED NET				
ACS180031	82 x 66 x 100		1	34.99

BLAX WATERPROOF LANDING NET PVC BAG

- Fully waterproof PVC bag to prevent leakage and odours.



CODE	DIMENSIONS (IN)	DIMENSIONS (CM)	GENCOD	TRADE PACK	RRP (€)
BLAX WATERPROOF LANDING NET PVC BAG					
ACS070024	—	125		1	15.99

CARPSPIRIT LANDING NET SPARE BLOCK

- Replacement spreader block compatible with most landing net poles.
- Fitted with a standard 3/8 inch screw thread.



CODE	DIMENSIONS (IN)	DIMENSIONS (CM)	GENCOD	TRADE PACK	RRP (€)
LANDING NET SPARE BLOCK					
465001360	—	—		1	7.39





CARPSPIRIT REPLACEMENT MESH

- A high quality replacement mesh. Compatible with Magnum X1 and BLAX landing nets.
- Reinforced top stitching.
- Features screen printed Carp Spirit logo in mesh.
- Super soft and fish friendly.
- Includes stitched magnet for fixing.



CODE	DIMENSIONS (IN)	DIMENSIONS (CM)	GENCOD	TRADE PACK	RRP (€)
REPLACEMENT MESH					
ACS180023	42 x 42	105 x 105		1	31.69

CARPSPIRIT LANDING NET FLOAT

- Very practical and very easy to install; that foam float will support your landing net and will release your hand in difficult phases of fight.



CODE	DIMENSIONS (IN)	DIMENSIONS (CM)	GENCOD	TRADE PACK	RRP (€)
LANDING NET FLOAT					
ACC010021	—	—		1	6.59

CARP CARE & WEIGHING



BLAX BOAT MAT

- Generously padded & compact design.
- Wipe clean fish friendly PVC lining.
- Very good flotation for the release in the water.
- Reinforced carry straps.
- Raised sides and folder over flap protection.



CODE	DIMENSIONS (CM)	WEIGHT (KG)	GENCOD	TRADE PACK	RRP (€)
BLAX BOAT MAT					
948000361	100 x 55 x 25	2.65		1	85.99



CLAUDIA DARGA 
 @claudiadarga

BLAX CRADLE XL

- Full perimeter padding.
- Waterproof PVC lining.
- Rubber mesh drainage.
- Rapid set up.
- 360 XL mud feet.
- Folds flat for easy transportation.
- Velcro carry handles.
- Retention overflap with Velcro.



CODE	DIMENSIONS (CM)	WEIGHT (KG)	GENCOD	TRADE PACK	RRP (€)
BLAX CRADLE XL					
ACS070086	125(L) x 70(W) x 38(H)	5.75		1	117.99

CARP SPIRIT CRADLE

- Full perimeter padding.
- Waterproof PVC lining.
- Rubber mesh drainage.
- Rapid set up.
- Folds flat for easy transportation.
- Velcro carry handles.
- Retention overflap with Velcro.



CODE	DIMENSIONS (CM)	WEIGHT (KG)	GENCOD	TRADE PACK	RRP (€)
CRADLE					
ACS070087	100(L) x 60(W) x 38(H)	4.55		1	74.99

CARP SPIRIT WEIGHT / STORAGE FLOATING BAG

- Designed to weigh and store the fish in the best conditions.
- Drainage sides for a better circulation of water.
- Full zip allowing full opening bag with safety clip.
- Equipped with floats to keep the bag at surface.
- Supplied with carrying bag.



CODE	DIMENSIONS (CM)	WEIGHT (KG)	GENCOD	TRADE PACK	RRP (€)
WEIGHT / STORAGE FLOATING BAG					
ACC070007	120(H) x 65(W)	0.9		1	44.99

BLAX RETENTION SLING

- A large weigh sling that can also be used for short term fish retention.
- Manufactured from a soft and fish friendly material that provides good water flow. It's equipped with a strong easy access zip, safety carabiner and 2m cord with a fluorescent orange float. Supplied in a carry case.



CODE	DIMENSIONS (CM)	WEIGHT (KG)	GENCOD	TRADE PACK	RRP (€)
BLAX RETENTION SLING					
ACS070088	100 x 55 x 25	2.65		1	26.99



BLAX DELUXE WEIGH SLING

- Strong, carp friendly support.
- Featuring heavy duty zip up sides, velcro secure fixings and folding Aluminium bars.
- Rapid drain mesh section.
- Safely release all fish.



CODE	DIMENSIONS (CM)	WEIGHT (KG)	GENCOD	TRADE PACK	RRP (€)
BLAX DELUXE WEIGH SLING					
689001361	120 x 55	0.88		1	48.99

BLAX WEIGH SLING

- Carp friendly support.
- Featuring zip up sides and folding Aluminium bars.
- Rapid drain mesh section.
- Safely release all fish.



CODE	DIMENSIONS (CM)	WEIGHT (KG)	GENCOD	TRADE PACK	RRP (€)
BLAX WEIGH SLING					
301001360	120 x 55	0.88		1	37.99

CARP SPIRIT WEIGH SLING BAG

- Weighing bag made from a soft and fish-friendly material.
- Equipped with 2 corless to secure when weighing.
- Supplied with a carrying case.



CODE	DIMENSIONS (CM)	WEIGHT (KG)	GENCOD	TRADE PACK	RRP (€)
WEIGH SLING BAG					
ACS070089	100(W) x 50(H)	0.20		1	13.99

CARP SPIRIT STURGEON MAT

NEW 2025

- Perfect Mat to protect big fish such as Catfish and Sturgeon.
- Foldable mat with 9 panels for easy transportation.
- Elastic retaining strap.
- Thickness 1.5mm.
- Dimensions 250 x 100cm.



CODE	DIMENSIONS (CM)	GENCOD	TRADE PACK	RRP (€)
STURGEON MAT				
ACS070090	250 x 100	—	1	59.99

CARP SPIRIT CARP MAT

- Folding unhooking mat.
- Elastic straps to secure.



CODE	DIMENSIONS (CM)	GENCOD	TRADE PACK	RRP (€)
CARP MAT				
ACC070010	85(L) x 45(W)	—	1	10.69

CARP SPIRIT CARP MAT

- Folding unhooking mat.
- Elastic straps to secure.



CODE	DIMENSIONS (CM)	GENCOD	TRADE PACK	RRP (€)
CARP MAT				
ACC070002	115(L) x 65(W)	—	1	25.99

BLAX SCALE TRIPOD

- Light and stable.
- Telescopic legs for easy storage.
- Supplied with carry bag.



CODE	WEIGHT (KG)	GENCOD	TRADE PACK	RRP (€)
SCALE TRIPOD				
124600360	3.8		1	86.99

CARP SPIRIT DIGITAL SCALE 100KG

NEW 2025

- Weighs in both kg & lbs.
- Weighs up to 100kg.
- Precision: 50g.
- Hold function.
- Thermometer function °C/°F.
- Accepts 2 x AAA batteries (not included).
- Supplied with carry case.



CODE	GENCOD	TRADE PACK	RRP (€)
DIGITAL SCALE 100KG			
ACS070099		1	59.99

CARP SPIRIT DIGITAL SCALE 50KG

NEW 2025

- LCD screen with 4 digit display.
- Maximum capacity: 50kg.
- Precision: 50g.
- Works with 2XAAA battery (not included).
- Thermometer function °C and °F.
- Hold function.
- Measurement units: kg, lbs, st.



CODE	GENCOD	TRADE PACK	RRP (€)
DIGITAL SCALE 50KG			
ACS070091		1	49.99

BLAX DIAL SCALE 54KG

- A high quality, reliable and robust scale that offers superb value.
- Impact resistant Polycarbonate construction body and lens.
- Calibrated at 200g units and tested to CE standards.
- Padded protection bag included.



CODE	WEIGHT (KG)	GENCOD	TRADE PACK	RRP (€)
DIAL SCALE 54KG				
ACS010400	1.24		1	34.99

CARPSPIRIT CLASSIC SCALE 50KG

- A reliable and robust dial scale, offering excellent value for money.
- Shock resistant case, weighs up to 50kg in units of 200g and supplied with a padded protective bag.



CODE	WEIGHT (KG)	GENCOD	TRADE PACK	RRP (€)
CLASSIC SCALE 50KG				
ACS170043	1.4		1	26.49

BOATS

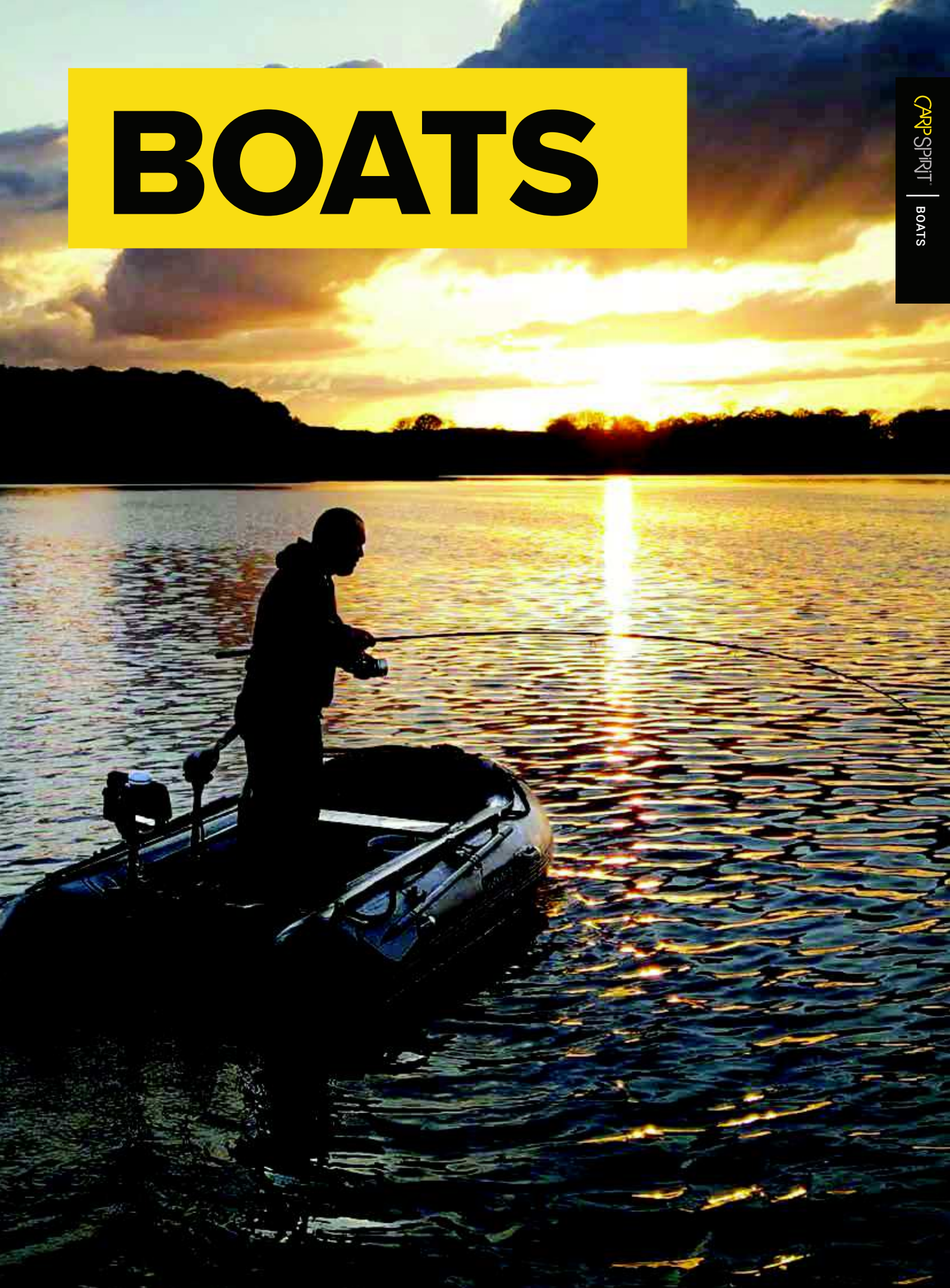

BOATS

BLACK BOAT
320W

856

BLACK BOAT
300WI

856

BLACK BOAT
300WI

857

BLACK BOAT
300WI

857

Product Code	ACS780026	ACS780025	ACS780024	ACS780023
Key USP	AN EXTREME BOAT FOR THE MOST EXTREME CONDITIONS	HUGE INTERNAL SPACE	OUR MOST VERSATILE BOAT	GREAT QUALITY, ALL ROUND BOAT
Length (cm)	320	300	270	240
Width (cm)	164	164	154	142
Internal Length (cm)	213	213	184	173
Weight (kg)	55	44	41	35
Max Power (HP)	15	12	10	4
Max Load (kg)	566	525	484	350
Max Person	4	4	3	2
Material thickness	0.9	0.9	0.9	0.9
Chamber system	3+1	3+1	3+1	3+1
Floor	Aluminium	Inflatable	Inflatable	Inflatable
Anti-return inflation valve	●	●	●	●
Inflatable keel	●	●	●	●
Front cleat	●	●	●	●
Side handles	●	●	●	●
Rear grab handles	●	●	●	●
Oars	●	●	●	●
Seat	2	1	1	1
Transom with support plate	●	●	●	●
Perimeter rope	●	●	●	●
Front stainless steel ring	●	●	●	●
Storage bag	●	●	●	●
Foot pump	●	●	●	●
Repair kit	●	●	●	●



**BLACK BOAT
ALU 270**

**BLACK BOAT
ALU 230**

**BLACK BOAT
ONE 230**

**BLACK BOAT
ONE 180**



859

859

861

861

ACS780032

ACS780031

ACS780005

ACS780004

EXCEPTIONAL STABILITY

EXCEPTIONAL
PERFORMANCE
AND VALUE

PERFECT FOR
SMALL WATERS

270	230	230	180
151	132	132	124
199	175.6	163	125
53	44	29	25
10	4	4	2
484	350	350	170
3	2	2	1
0.9	0.9	0.7	0.7
3+1	3+1	3	2
Aluminium	Aluminium	Slatted Wood	Slatted Wood
●	●	●	●
●	●	—	—
●	●	—	—
●	●	●	●
●	●	—	—
●	●	●	●
1	1	1	1
●	●	●	●
●	●	●	●
●	●	●	●
●	●	●	●
●	●	●	●
●	●	●	●



BLACK BOAT

When the Black Boat series was first introduced, Carp Spirit became one of the very first brands to produce inflatable boats specifically developed for carp fishing. Now established as a market leader and a benchmark throughout Europe, the latest range of Black Boats have now been improved even further to meet the demands and expectations of the modern-day carp angler.

Packed with new and additional features such as improved inflatable floors, new handles, and increased width to provide even more space and greater stability; all this alongside superb durability to provide years of service. Black Boats... **'The Benchmark'** in carp fishing boats.

- 3+1 Inflatable chamber system.
- Heavy duty 0.9mm canvas with re-enforced side and base for extra protection.
- Inflatable floor (240WI, 270WI & 300WI) with front anti-return valve location. Aluminium floor (320W).
- Built-in floor strengthening ribs for super rigidity.
- Battery protection with strap located at the back.
- Inflatable and reinforced keel cuts through the waves and keeps the nose on course.
- One-way multi point inflation valves.
- Safety overpressure valve.



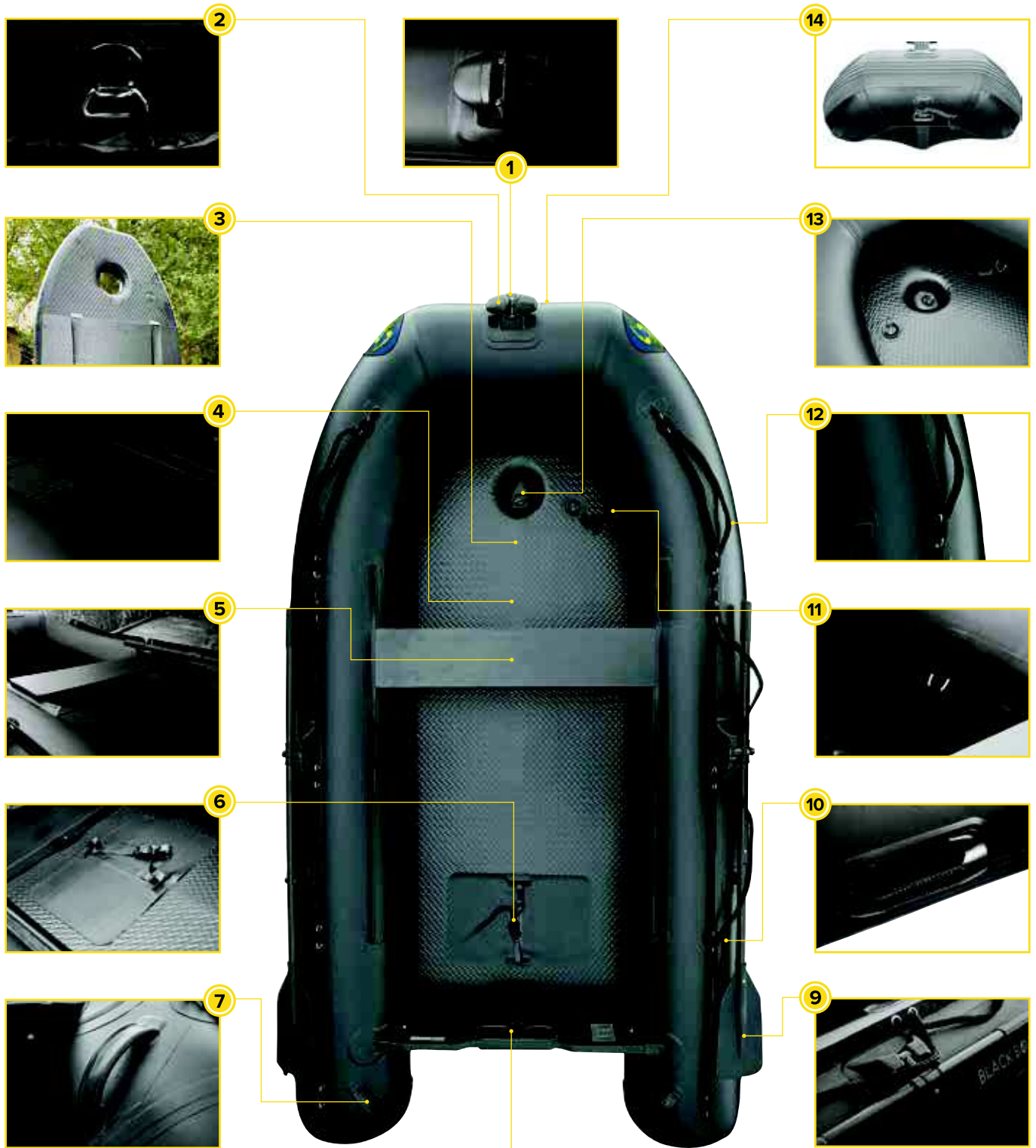

*270WI / 300WI / 320WI

THE DETAIL

- ① Cleat at the front to stabilise the boat, even with one hand.
- ② Stainless steel ring at the front.
- ③ Inflatable floor (240WI, 270WI & 300WI).
- ④ Black Aluminium floor for stability (320W model only).
- ⑤ Removable and adjustable seats.
- ⑥ Battery protection with strap.
- ⑦ Extra strong grab handle on the rear.*
- ⑧ Extra strong transom with motor support plate.
- ⑨ Removable black oars with secure fixing screws.
- ⑩ Side multi-use handles.
- ⑪ Internal stainless ring with fixing cord included.
- ⑫ Side rope.
- ⑬ Floor inflation valve with anti-return.
- ⑭ Inflatable and reinforced keel.



Heavy duty 0.9mm canvas with re-enforced side and base for extra protection.



Storage bag, large volume foot pump and repair kit included.

BLACK BOAT 320W

An extreme boat for the most extreme conditions, the 320W is built for the most demanding of situations. With its additional pair of moulded front handles, an Aluminium floor, 2 seats and with an engine rating power of up to 15HP, this boat is the perfect tool for any big lake, huge rivers, or even giant catfish fishing. Perfect to move all your equipment from one side of the lake to the other at a moment's notice, whatever the weather; it is even big enough to sleep in.

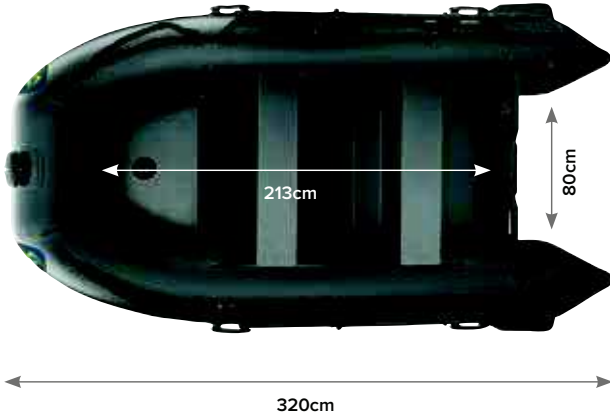

DETAIL

- Side tubes diameter – 42cm
- Side tubes maximum pressure 5PSI / 0.34BAR

CODE	WEIGHT (KG)	MAX POWER (HP)	MAX LOAD (KG)	MAX PERSON	GENCOD	TRADE PACK	RRP (€)
BLACK BOAT 320W							
ACS780026	55	15	566	4		1	1549.99

BLACK BOAT 300WI

With its huge internal space, the 300WI boat is dedicated to large waters and can easily transport an angler and enough equipment for the longest of endurance sessions.

*Inflatable floor.

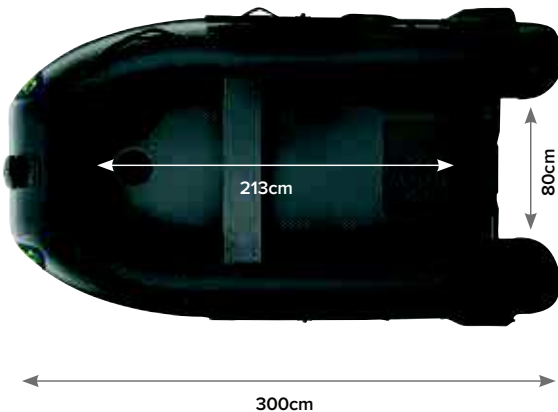

DETAIL

- Side tubes diameter – 42cm
- Side tubes maximum pressure 5PSI / 0.34BAR
- Mat maximum pressure 12PSI / 0.82BAR

CODE	WEIGHT (KG)	MAX POWER (HP)	MAX LOAD (KG)	MAX PERSON	GENCOD	TRADE PACK	RRP (€)
BLACK BOAT 300WI							
ACS780025	44	12	525	4		1	1449.99

BLACK BOAT 270_{WI}

The most versatile size of all, very capable in big waters and strong waves, yet still retains excellent manoeuvrability.

*Inflatable floor.

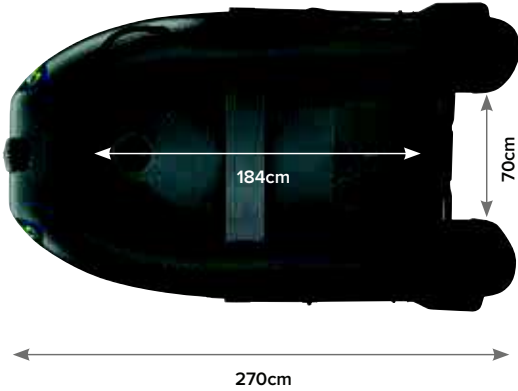

DETAIL

- Side tubes diameter – 42cm
- Side tubes maximum pressure 5PSI / 0.34BAR
- Mat maximum pressure 12PSI / 0.82BAR

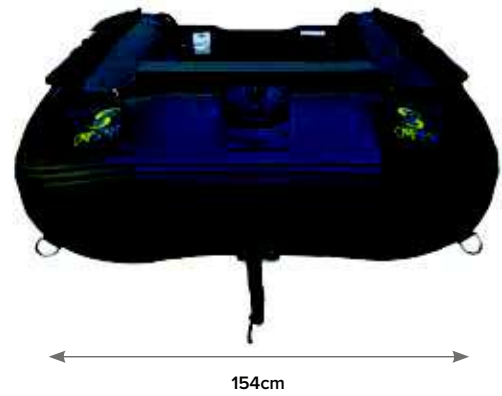

CODE	WEIGHT (KG)	MAX POWER (HP)	MAX LOAD (KG)	MAX PERSON	GENCOD	TRADE PACK	RRP (€)
BLACK BOAT 270WI							
ACS780024	41	10	484	3		1	1319.99

BLACK BOAT 240_{WI}

Light enough to be moved by 1 person, perfect for baiting, dropping rigs, playing fish with 2 people on board. Shaped to offer great stability – even in bad weather, the 240WI does it all.

*Inflatable floor.

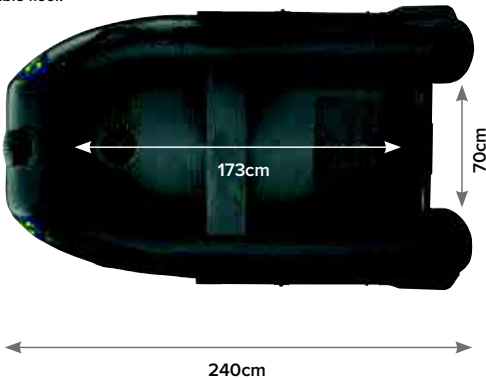

DETAIL

- Side tubes diameter – 36cm
- Side tubes maximum pressure 5PSI / 0.34BAR
- Mat maximum pressure 12PSI / 0.82BAR



CODE	WEIGHT (KG)	MAX POWER (HP)	MAX LOAD (KG)	MAX PERSON	GENCOD	TRADE PACK	RRP (€)
BLACK BOAT 240WI							
ACS780023	35	4	350	2		1	1049.99



BLACK BOAT ALU 270 NEW 2025

- Black aluminium floor for better stability.
- Inflatable chamber 3+1.
- A unique interior volume walk through the back of the transom.
- Cutting the wave and staying the course with its protected Inflatable keel.
- Cleat at the front to stabilize the boat even with one hand.
- Canvas 0.9mm with side and bottom protections for durability.
- Rope around the edge.
- Stainless steel ring at the front.
- Side multi-use handles.
- Removable black oars with secure fixing screws.
- Transom with motor support plate.
- Inflation valves two positions with anti-return.
- Bag for flooring and boat.
- Foot pump large volume and repair kit included.

DETAIL

- Side tubes maximum pressure **5PSI / 0.34BAR**
- Mat maximum pressure **12PSI / 0.82BAR**



CODE	WEIGHT (KG)	MAX POWER (HP)	MAX LOAD (KG)	MAX PERSON	GENCOD	TRADE PACK	RRP (€)
BLACK BOAT ALU 270							
ACS780032	52.7	10	484	3		1	1399.99

BLACK BOAT ALU 230 NEW 2025

- Black aluminium floor for better stability.
- Inflatable chamber 3+1.
- A unique interior volume walk through the back of the transom.
- Cutting the wave and staying the course with its protected Inflatable keel.
- Cleat at the front to stabilize the boat even with one hand.
- Canvas 0.9mm with side and bottom protections for durability.
- Rope around the edge.
- Stainless steel ring at the front.
- Side multi-use handles.
- Removable black oars with secure fixing screws.
- Transom with motor support plate.
- Inflation valves two positions with anti-return.
- Bag for flooring and boat.
- Foot pump large volume and repair kit included.

DETAIL

- Side tubes maximum pressure **5PSI / 0.34BAR**
- Mat maximum pressure **12PSI / 0.82BAR**

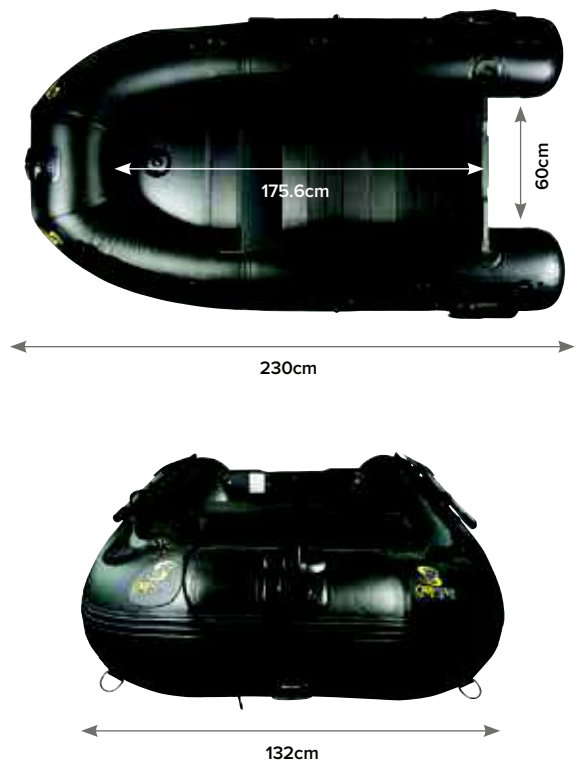

CODE	WEIGHT (KG)	MAX POWER (HP)	MAX LOAD (KG)	MAX PERSON	GENCOD	TRADE PACK	RRP (€)
BLACK BOAT ALU 230							
ACS780031	43.8	4	350	2		1	999.99

BLACK BOAT ONE

Our entry level offering for the inflatable boat range. Featuring 2 models (180 and 230), the Black Boat One is the perfect option for smaller waters and the introductory step into fishing with a boat. The feature packed models include:

- Inflatable chamber system (180: 2 chambers, and 230: 3 chambers).
- Heavy duty 0.7mm canvas with re-enforced side and base for extra protection.
- Slatted floor (width of slat 20cm).
- Removable and adjustable seat.
- Side rope.
- Removable black oars with secure fixing screws.
- Transom with motor support plate.
- Anti- return inflation valves.

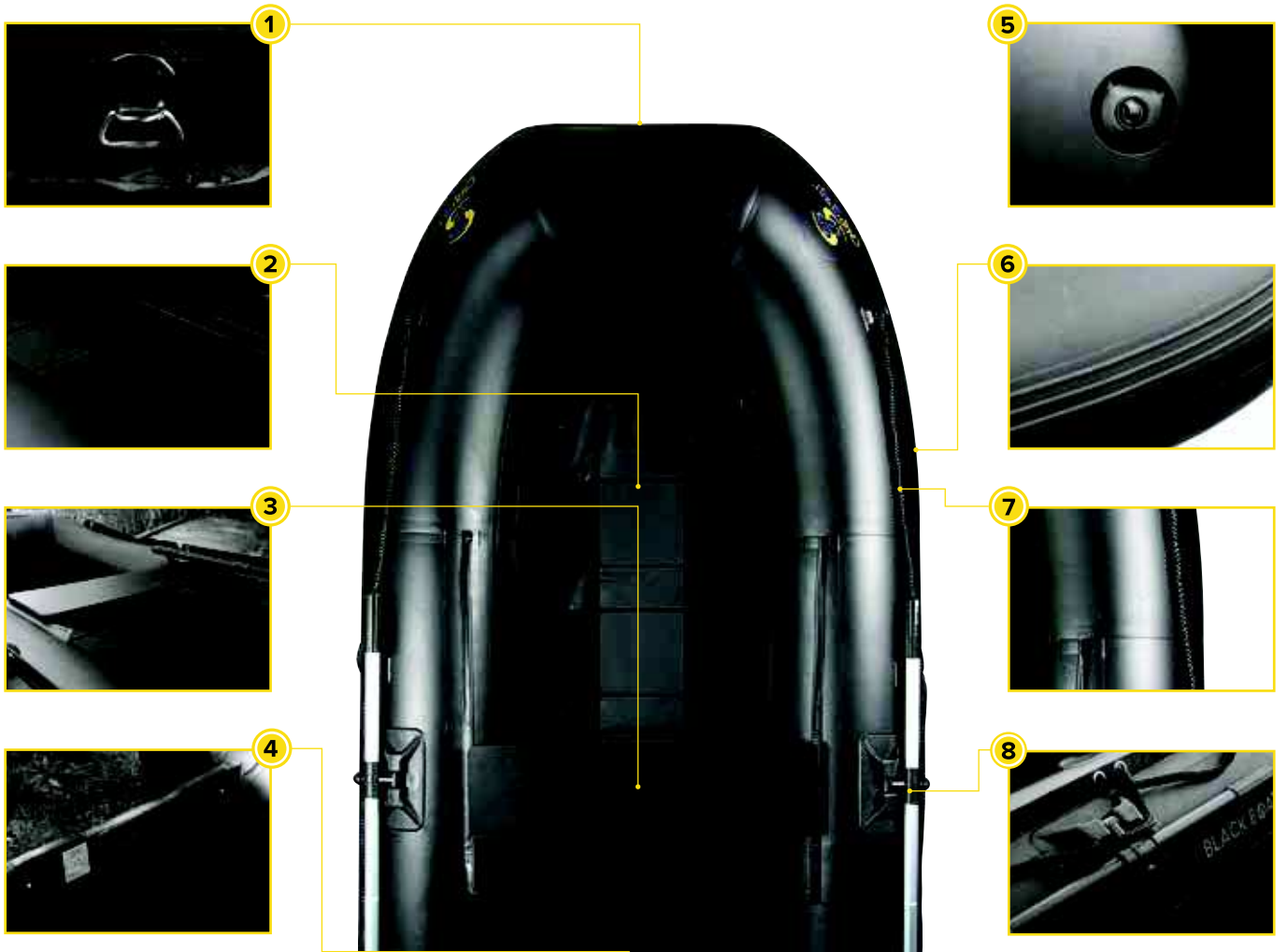

THE DETAIL

- ① Stainless steel ring at the front.
- ② Slatted floor (width of slat 20cm).
- ③ Removable and adjustable seat.
- ④ Transom with motor support plate.
- ⑤ Inflation valves with anti-return.
- ⑥ Heavy duty 0.7mm canvas with re-enforced side and base for extra protection.
- ⑦ Side rope.
- ⑧ Removable black oars with secure fixing screws.



Storage bag, large volume foot pump and repair kit included.



BLACK BOAT ONE 230

DETAIL

- Side tubes diameter – 36cm
- Side tubes maximum pressure 5PSI / 0.34BAR



230cm

132cm

CODE	WEIGHT (KG)	MAX POWER (HP)	MAX LOAD (KG)	MAX PERSON	GENCOD	TRADE PACK	RRP (€)
BLACK BOAT ONE 230							
ACS780005	29	4	350	2		1	769.99

BLACK BOAT ONE 180

DETAIL

- Side tubes diameter – 32cm
- Side tubes maximum pressure 5PSI / 0.34BAR

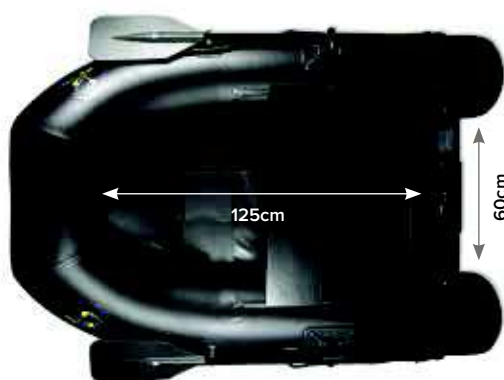

180cm

124cm

CODE	WEIGHT (KG)	MAX POWER (HP)	MAX LOAD (KG)	MAX PERSON	GENCOD	TRADE PACK	RRP (€)
BLACK BOAT ONE 180							
ACS780004	25	2	170	1		1	669.99

PUMP BOAT & FLOAT TUBE

- Pump for the Black Boat and Black Boat One range.



CODE	DIMENSIONS (CM)	BOAT VERSION	GENCOD	TRADE PACK	RRP (€)
PUMP BOAT & FLOAT TUBE					
ACS780009	—	All		1	41.99

REPAIRING KIT BOAT & FLOAT TUBE

- Repair Kit for the Black Boat and Black Boat One range.
- Includes: 2 patch strips (22x12cm), tube of glue, wrench for valve, instructions for use.



CODE	DIMENSIONS (CM)	BOAT VERSION	GENCOD	TRADE PACK	RRP (€)
REPAIRING KIT BOAT & FLOAT TUBE					
ACS780010	—	All		1	10.49

QUICK RELEASE BOAT CLIP

- 1.35m long heavy-duty bungee.
- One hand operation quick release system.
- Hi-Viz puller float.
- Oversize sliding main float – self adjusts.
- Stainless steel construction quick clip.



CODE	DIMENSIONS (CM)	BOAT VERSION	GENCOD	TRADE PACK	RRP (€)
QUICK RELEASE BOAT CLIP					
ACS010403	135	All		1	26.49

CORD 15M

- Multi-use cord (15m long / 10mm diameter).
- Rot-proof polypropylene.
- Ideal for holding down bulky items, mooring boats and much more.



CODE	WEIGHT (KG)	GENCOD	TRADE PACK	RRP (€)
CORD 15M				
ACS010117	0.45		1	9.49

BLACK BOAT OARS

- Spare Oars for the the Black Boat and Black Boat One range.



CODE	LENGTH (CM)	BOAT VERSION	GENCOD	TRADE PACK	RRP (€)
BLACK BOAT OARS					
ACS780007	131	All		1	46.99
ACS780008	161	All		1	54.49

CARRY BAG BLACK BOAT

- Carry bag for the Black Boat range.



CODE	BOAT VERSION	GENCOD	TRADE PACK	RRP (€)
CARRY BAG BLACK BOAT				
ACS780011	All Black Boat Models		1	65.99
ACS780012	All Black Boat One Models		1	54.99



VALVE & FLOAT TUBE

- Valve for the Black Boat and Black Boat One range.



CODE	DIMENSIONS (CM)	BOAT VERSION	GENCOD	TRADE PACK	RRP (€)
VALVE & FLOAT TUBE					
ACS780015	—	All		1	6.19

SAFETY TUBE & FLOAT TUBE

- Safety Valve for the Black Boat and Black Boat One range.



CODE	DIMENSIONS (CM)	BOAT VERSION	GENCOD	TRADE PACK	RRP (€)
SAFETY TUBE & FLOAT TUBE					
ACS780016	—	All		1	7.29

SEAT

- Seat for the Black Boat.



CODE	DIMENSIONS (CM)	BOAT VERSION	GENCOD	TRADE PACK	RRP (€)
SEAT					
ACS780021	90 x 20	240WI/270WI		1	31.99
ACS780022	100 x 20	300WI/320W		1	34.49



**INFLATABLE
FLOOR MATT**



CODE	BOAT VERSION	GENCOD	TRADE PACK	RRP (€)
INFLATABLE FLOOR MATT				
ACS780029	300WI		1	124.99
ACS780028	270WI		1	120.49
ACS780027	240WI		1	114.99



WATER SCANNER

- Perfect for clear waters; helps identify the nature of the bottom and any key features.
- 2 side handles.
- Foldable for space saving and storage.
- Supplied in transport bag.



CODE	DIMENSIONS	GENCOD	TRADE PACK	RRP (€)
WATER SCANNER				
ACS010208	Transport case – 28cm x 31cm		1	89.99

PRODDING STICK

- 4.5m three section (1.5m each) pole.
- Help determine the nature of the bottom.
- Supplied with transport bag.

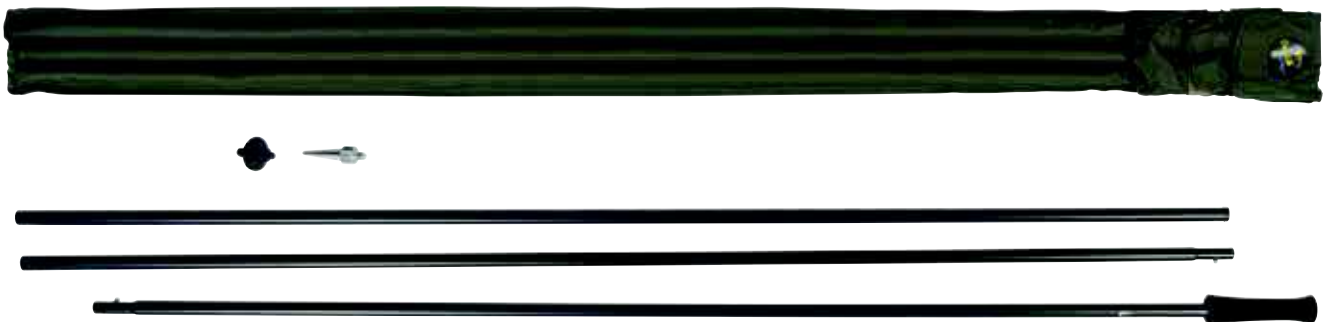

CODE	DIMENSIONS	GENCOD	TRADE PACK	RRP (€)
PRODDING STICK				
ACS010019	4.5m		1	53.99

HOOKS & READY RIGS



RAZOR point

Since their Launch, Razor point hooks have become a firm favourite with Carp Anglers from around the World. With thousands of Carp hooked and safely landed on them, it's easy to see why so many anglers trust and finish their rigs off with our Razor point hooks. Designed from scratch, and tested to the extreme in both in the laboratory and in real world fishing situations by our Global team, you can be confident that whichever Razor Point hook you choose it won't let you down. Attention to detail is everything; each Razor point hook is made to ultra-fine tolerances, carefully tempered using a computer controlled process and chemically sharpened using Durapoint technology. The comprehensive range ensures that whatever angling situation you're faced with, there's a perfect hook pattern for it. We believe our range of Razor point carp hooks are the most technically advanced on the market today – Something we are extremely proud of.

Now with 80% less plastic packaging.

- **Dura-Point Technology** – The sharpest, longest, most durable hooks points in the carp hook World – Even after multiple uses.
- **High Carbon Steel** – Raw material choice is critical, and we only use the best quality high carbon steel available to produce our Razor point carp hooks, providing the very best strength, durability and reliability.
- **PTFE Finish** – The smooth PTFE finish not only reduces glare to avoid spooking wary carp, but also reduces friction, therefore aiding penetration speed by up to 50%.
- **Closed Eye** – Each hook eye is precisely formed to ensure it's truly 'closed' to ensure that zero damage occurs to your hook link, particularly when using the 'knotless knot' and perfect for low diameter hook links or braid.
- **Micro Barb** – Ultra small Micro barbs are designed to offer an extraordinary hook hold during the fight yet minimise mouth damage during unhooking.

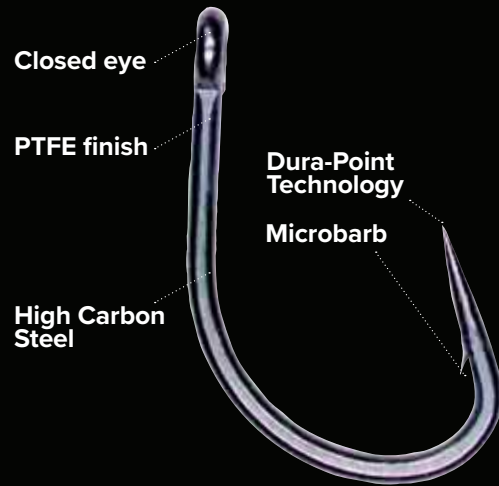

"Sharpest hooks, straight from the packet."

Ian Russell



Round-Curve



V-Curve



V-Curve XS



Long Shank



Boilie Beak Point



Medium Curve Shank



Continental Xtra Strong



Short Curve Shank

HOOKS

RAZOR ROUND-CURVE NEW 2025

● The most recent addition to the Razor Point range of hooks is the Round-Curve. Perfect for all kinds of rigs from Waffer rigs to the more modern favourite Ronnie Rig. When you are playing a fish, this shape hook hold just gets better under pressure. Several very large Carp have already fallen for the Round-Curve whilst being field-tested.

- Super strong & incredibly sharp.
- PTFE coating.
- Available in both barbed and barbless in sizes 2, 4 and 6.



CODE	HOOK SIZE	HOOK TYPE	QUANTITY	GENCOD	TRADE PACK	RRP (€)
ROUND-CURVE						
ACS350099	2	Micro Barbed	10		5	5.69
ACS350100	4	Micro Barbed	10		5	5.69
ACS350101	6	Micro Barbed	10		5	5.69
ACS350102	2	Barbless	10		5	5.69
ACS350103	4	Barbless	10		5	5.69
ACS350104	6	Barbless	10		5	5.69

RAZOR V-CURVE

- Distinct 'V' shaped bend that results in less hook movement and hook pulls.
- The ultrawide gape and short shank provides ultimate penetration.
- In-turned points are perfect for fishing over stones and gravel.

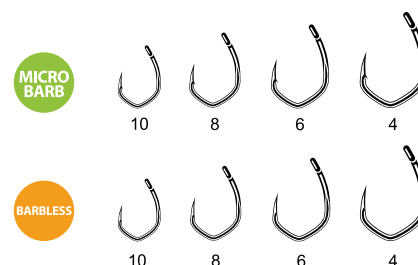

CODE	HOOK SIZE	HOOK TYPE	QUANTITY	GENCOD	TRADE PACK	RRP (€)
V-CURVE						
ACS350089	4	Micro Barbed	10		5	5.69
ACS350088	6	Micro Barbed	10		5	5.69
ACS350087	8	Micro Barbed	10		5	5.69
ACS350086	10	Micro Barbed	10		5	5.69
ACS350098	4	Barbless	10		5	5.69
ACS350097	6	Barbless	10		5	5.69
ACS350096	8	Barbless	10		5	5.69
ACS350095	10	Barbless	10		5	5.69

RAZOR V-CURVE XS

- Features a thicker wire gauge than the standard versions, making it 30% stronger, ideal for massive carp or heavy-duty snag fishing.

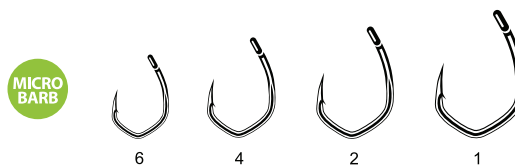

CODE	HOOK SIZE	HOOK TYPE	QUANTITY	GENCOD	TRADE PACK	RRP (€)
V-CURVE XS						
ACS350093	1	Micro Barbed	10		5	5.69
ACS350092	2	Micro Barbed	10		5	5.69
ACS350091	4	Micro Barbed	10		5	5.69
ACS350090	6	Micro Barbed	10		5	5.69

RAZOR LONG SHANK

- Versatile, strong, and reliable, the LS pattern has been designed to cope with a wide variety of carp fishing situations.
- The in-turned eye, straight point and forged shank makes the LS pattern perfectly suited for both hair-rigged bottom baits and pop-up boilies. It is the perfect choice for sliding ring anti-eject rigs.

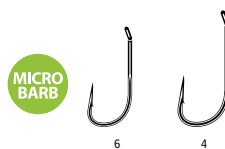

CODE	HOOK SIZE	HOOK TYPE	QUANTITY	GENCOD	TRADE PACK	RRP (€)
LONG SHANK						
ACS350030	4	Barbed	10		5	5.69
ACS350032	6	Barbed	10		5	5.69

RAZOR BOILIE BEAK POINT

- With its in-turned beaked point, the BBP is an excellent hook choice when fishing over gravel or rocky bottoms as there is less chance of the hook point becoming damaged.
- The short shank and straight eye has a slight in-turn, making it ideal for a huge array of presentations including snowman rigs, bottom baits or pop-up boilies.

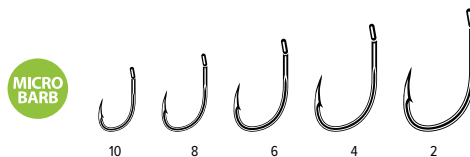

CODE	HOOK SIZE	HOOK TYPE	QUANTITY	GENCOD	TRADE PACK	RRP (€)
BOILIE BEAK POINT						
ACS350040	2	Barbed	10		5	5.69
ACS350041	4	Barbed	10		5	5.69
ACS350043	6	Barbed	10		5	5.69
ACS350045	8	Barbed	10		5	5.69
ACS350046	10	Barbed	10		5	5.69

RAZOR MEDIUM CURVE SHANK

- The MCS has been created by combining the benefits of a long shank with the aggressive hooking of a curved style pattern. The slightly downturned eye ensures the hook turns instantly, ready for maximum penetration.
- Suitable for a wide degree of presentations, including the popular '360' and 'Ronnie' style rigs.

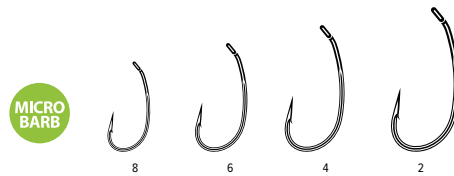

CODE	HOOK SIZE	HOOK TYPE	QUANTITY	GENCOD	TRADE PACK	RRP (€)
MEDIUM CURVE SHANK						
ACS350051	2	Barbed	10		5	5.69
ACS350052	4	Barbed	10		5	5.69
ACS350054	6	Barbed	10		5	5.69
ACS350056	8	Barbed	10		5	5.69

RAZOR CONTINENTAL XS

- The thicker wire gauge of the CXS provides a much stronger hook than normal for the most demanding of situations and has accounted for some of the biggest Carp landed in the World, it is also a great choice for heavy duty snag fishing.
- The short shank and wide gape, makes it ideal for most hair-rig presentations.

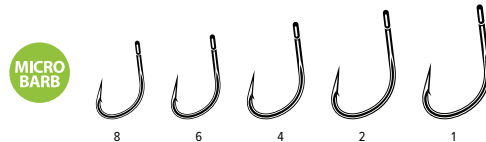

CODE	HOOK SIZE	HOOK TYPE	QUANTITY	GENCOD	TRADE PACK	RRP (€)
CONTINENTAL XS						
ACS350081	1	Barbed	10		5	5.69
ACS350082	2	Barbed	10		5	5.69
ACS350083	4	Barbed	10		5	5.69
ACS350084	6	Barbed	10		5	5.69
ACS350085	8	Barbed	10		5	5.69

RAZOR SHORT CURVE SHANK

- Our most popular Razor point hook pattern – The SCS is robust, ultra-sharp and incredibly strong. It is also the most versatile, which means it can be used to create a wealth of presentations including hair-rigged bottom baits or pop-up boilies.
- It is the perfect choice for snowman style presentations, Withy pool or a KD style rig.

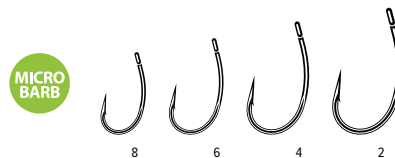

CODE	HOOK SIZE	HOOK TYPE	QUANTITY	GENCOD	TRADE PACK	RRP (€)
SHORT CURVE SHANK						
ACS350065	2	Barbed	10		5	5.69
ACS350066	4	Barbed	10		5	5.69
ACS350068	6	Barbed	10		5	5.69
ACS350070	8	Barbed	10		5	5.69

READY RIGS

RAZOR SPINNER RIG

- One of the most efficient rigs to present a low-lying pop-up. A big advantage of this rig, is the possibility to change the hook quickly and easily.
- Made using a CS Medium Curve Shank barbed hook, with a stop and micro-rig swivel mounted on it, spinner swivel covered in shrink tube, tied to 15cm of 0.55mm fluorocarbon hooklink.
- Available in sizes 4 & 6, in packs of two.



CODE	LENGTH (CM)	FLUOROCARBON DIAMETER (MM)	HOOK SIZE	PACK QUANTITY	GENCOD	TRADE PACK	RRP (€)
SPINNER RIG							
ACS340085	15	0.55	4	2		5	5.75
ACS340086	15	0.55	6	2		5	5.75

RAZOR CHOD RIG

- Constructed using super stiff 25lb Riga-Mortis hooklink, to ensure the shape is retained as much as possible.
- Available in size 4, 6 and 8 barbed versions, at long and short lengths, in packets of three.



THE DETAIL

- 1 Razor Point Stiff Rig/Chod Hook.
- 2 25lb Riga-Mortis Hooklink.
- 3 Size 11 Ring Swivel.

CODE	LENGTH (CM)	BREAKING STRAIN (LB)	HOOK SIZE	SWIVEL SIZE	PACK QUANTITY	GENCOD	TRADE PACK	RRP (€)
CHOD RIG								
ACS340023	8.25	25	4	11	3		5	5.19
ACS340025	8.25	25	6	11	3		5	5.19
ACS340027	8.25	25	8	11	3		5	5.19

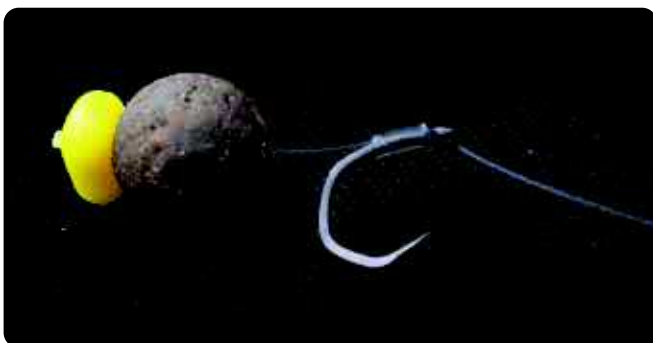

RAZOR 360 RIG

- The 360 Rig is regarded as one of the ultimate big fish pop-up rigs.
- The name is derived from the hooks ability to spin a full 360 degrees within the swivel loop, increasing the chances of the hook point getting a hold from whatever angle the fish takes the bait from.

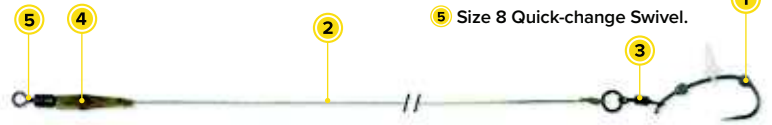

MICRO BARB

THE DETAIL

- 1 Razor Point Medium Curve Hook.
- 2 Camo Core Hooklink.
- 3 Rolling swivel with ring.
- 4 Mini Anti-tangle Sleeve.
- 5 Size 8 Quick-change Swivel.

CODE	LENGTH (CM)	BREAKING STRAIN (LB)	HOOK SIZE	SWIVEL SIZE	PACK QUANTITY	GENCOD	TRADE PACK	RRP (€)
360 RIG								
ACS340087	—	25	4	8	2		5	8.39
ACS340088	—	20	6	8	2		5	8.39
ACS340089	—	20	8	8	2		5	8.39

RAZOR BLOW BACK RIG

- The long shank pattern is perfect for the micro ring to slide along when the fish tries to eject the bait leaving the hook point clear and increasing the chances of finding a hold.
- A Carp Spirit Kicker line aligner is also added to the rig to aid rapid turning of the hook point.
- This versatile rig is perfect for use with both bottom baits and pop-ups.

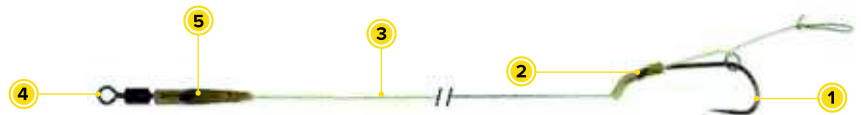

MICRO BARB

THE DETAIL

- 1 Razor Point Long Shank Hook.
- 2 Kicker Line Aligner.
- 3 Camo Core Hooklink.
- 4 Size 8 Quick-change Swivel.
- 5 Mini Anti-tangle Sleeve.

CODE	LENGTH (CM)	BREAKING STRAIN (LB)	HOOK SIZE	SWIVEL SIZE	PACK QUANTITY	GENCOD	TRADE PACK	RRP (€)
BLOW BACK RIG								
ACS340090	—	25	4	8	2		5	7.29
ACS340091	—	20	6	8	2		5	7.29
ACS340092	—	20	8	8	2		5	7.29



RAZOR FLUOROCARBON 'D' RIG

- With Fluorocarbon having similar light refractive properties to water and no tubing present, the rig almost disappears when immersed in water.
- The Fluorocarbon 'D' rig is perfect for bottom baits, slow sinkers or snowman style setups.



THE DETAIL

- ① Razor Point Short Curve Shank Hook.
- ② Fluorocarbon.
- ③ Size 8 Quick-change Swivel.
- ④ Mini Anti-tangle Sleeve.



CODE	LENGTH (CM)	BREAKING STRAIN (LB)	HOOK SIZE	SWIVEL SIZE	PACK QUANTITY	GENCOD	TRADE PACK	RRP (€)
FLUOROCARBON 'D' RIG								
ACS340093	—	25	4	8	2		5	5.19
ACS340094	—	25	6	8	2		5	5.19
ACS340095	—	25	8	8	2		5	5.19

RAZOR PVA BAG HAIR RIG

- PVA Bag Rigs are short, braided rigs specifically designed for use with PVA Bags.
- Can easily be dropped directly into solid PVA bags or can be used in conjunction with PVA Mesh systems.



THE DETAIL

- ① Razor Point Boilie Beak Point Hook.
- ② Re-Action Braid.
- ③ Size 8 Quick-change Swivel.
- ④ Mini Anti-tangle Sleeve.



CODE	LENGTH (CM)	BREAKING STRAIN (LB)	HOOK SIZE	SWIVEL SIZE	PACK QUANTITY	GENCOD	TRADE PACK	RRP (€)
PVA BAG HAIR RIG								
ACS340058	—	20	4	8	2		5	5.19
ACS340059	—	20	6	8	2		5	5.19
ACS340060	—	20	8	8	2		5	5.19

RAZOR KD RIG

- Best fished with slow sinking critically balanced baits or a pop-up with a small split shot directly under the bait to act as a counterbalance.
- The hook retains an incredible amount of free movement making this a very effective rig that is renowned for good hook holds.



THE DETAIL

- ① Razor Point Short Curve Shank Hook.
- ② Camo Core Braid.
- ③ Size 8 Quick-change Swivel.
- ④ Mini Anti-tangle Sleeve.



CODE	LENGTH (CM)	BREAKING STRAIN (LB)	HOOK SIZE	SWIVEL SIZE	PACK QUANTITY	GENCOD	TRADE PACK	RRP (€)
KD RIG								
ACS340096	—	20	4	8	2		5	6.29
ACS340097	—	20	6	8	2		5	6.29
ACS340098	—	20	8	8	2		5	6.29

REACTION™ RIG

- A simple but highly effective rig tied using our fast-sinking Re-Action Braid.
- The soft and supple make up of Re-Action Braid make this the perfect choice rig for when using PVA bags.
- It can be fished with either bottom baits, pop-ups or snowman presentations by simply adding Tungsten Putty or a split shot onto the braid to counterbalance the bait.



CODE	LENGTH (CM)	BREAKING STRAIN (LB)	HOOK SIZE	SWIVEL SIZE	PACK QUANTITY	GENCOD	TRADE PACK	RRP (€)
REACTION RIG								
ACS340099	20	25	2	8	2		5	4.79
ACS340100	20	25	4	8	2		5	4.79
ACS340101	20	25	6	8	2		5	4.79

HERCULINE™ RIG

- Tied using our ultra soft and supple slow sinking Herculine™ Braid, this the perfect choice rig for when using PVA bags.
- The angled shrink tube over the hook eye also aids rapid turning of the hook point.
- It can be fished with either bottom baits, pop-ups or snowman presentations by simply adding Tungsten Putty or a split shot onto the braid to counterbalance the bait.

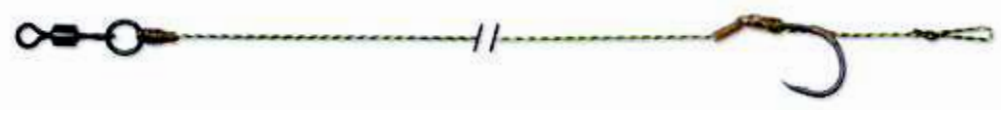

CODE	LENGTH (CM)	BREAKING STRAIN (LB)	HOOK SIZE	SWIVEL SIZE	PACK QUANTITY	GENCOD	TRADE PACK	RRP (€)
HERCULINE RIG								
ACS340102	20	25	2	8	2		5	4.79
ACS340103	20	25	4	8	2		5	4.79
ACS340104	20	25	6	8	2		5	4.79

OPTI-MEX™ RIG

- Pre-tied using the highest quality 100% Fluorocarbon Opti-Mex hooklink.
- The light refractive properties of fluorocarbon are very similar to that of water making them almost invisible.
- Excellent anti-tangle properties, they feature a slightly in-turned hook point design, ideal for fishing over gravel and particularly well suited to bottom baits or snowman style set ups.



CODE	LENGTH (CM)	BREAKING STRAIN (LB)	HOOK SIZE	SWIVEL SIZE	PACK QUANTITY	GENCOD	TRADE PACK	RRP (€)
OPTI-MEX RIG								
ACS340105	20	37.5	2	8	2		5	4.79
ACS340106	20	37.5	4	8	2		5	4.79
ACS340107	20	32.5	6	8	2		5	4.79

CLASSIC HAIR RIG

- Set of 2 hair rigs.
- Available in braided or fluorocarbon version.



CODE	LENGTH (CM)	BREAKING STRAIN (LB)	HOOK SIZE	SWIVEL SIZE	PACK QUANTITY	GENCOD	TRADE PACK	RRP (€)
CLASSIC HAIR RIG								
155400361	—	25	2	—	2		10	2.99
155500361	—	25	4	—	2		10	2.99
155600361	—	25	6	—	2		10	2.99

CLASSIC FLUORO RIG

- Tied using our ultra soft and supple slow sinking Herculine™ Braid, this the perfect choice rig for when using PVA bags.
- The angled shrink tube over the hook eye also aids rapid turning of the hook point.



CODE	LENGTH (CM)	BREAKING STRAIN (LB)	HOOK SIZE	SWIVEL SIZE	PACK QUANTITY	GENCOD	TRADE PACK	RRP (€)
CLASSIC FLUORO RIG								
157400361	—	25	4	—	2		10	2.99
157500361	—	25	6	—	2		10	2.99

CLASSIC DISTANCE RIG

- Available in 2 sizes (70g and 90g).
- Lead core 100cm.
- Trilobe lead.
- Plastic lead clip.
- Rolling swivel.



CODE	BREAKING STRAIN (LB)	HOOK SIZE	WEIGHT (G)	PACK QUANTITY	GENCOD	TRADE PACK	RRP (€)
DISTANCE RIG							
ACC090002	25	2	70	1		5	6.99
ACC090003	25	4	70	1		5	6.99
ACC090004	25	6	70	1		5	6.99
ACC090006	25	2	90	1		5	7.69
ACC090007	25	4	90	1		5	7.69

MAINLINE, LEADERS & HOOKLINKS

MAINLINE,
LEADERS &
HOOKLINKS



MONOFILAMENT MAINLINE

VELOCITY™ XS

- Our highest quality, extra-strong, premium monofilament designed and developed specifically for carp fishing.
- The unique co-polymer formulation results in excellent abrasion resistance yet still retains a high breaking strain to diameter ratio.
- Soft, supple line that sinks fast.



5000m



CODE	LENGTH (M)	DIAMETER (MM)	BREAKING STRAIN (KG)	BREAKING STRAIN (LB)	GENCOD	TRADE PACK	RRP (€)
VELOCITY™ XS LO-VIS GREEN							
ACS470035	1200	0.27	5.9	13.0		3	26.49
ACS470036	1200	0.30	7.0	15.5		3	26.49
ACS470037	1200	0.35	8.5	19.0		3	27.49
ACS470038	1200	0.40	11.8	26.0		3	28.49
ACS470086	5000	0.30	7.0	15.5		1	61.99
ACS470087	5000	0.35	8.5	19.0		1	71.99
ACS470088	5000	0.40	11.8	26.0		1	81.99
VELOCITY™ XS LO-VIS CAMO							
ACS470075	1200	0.27	5.9	13.0		3	28.49
ACS470076	1200	0.30	7.0	15.5		3	28.49
ACS470077	1200	0.35	8.5	19.0		3	29.49
ACS470078	1200	0.40	11.8	26.0		3	31.49

CELT-2X™

- Carp Spirit Celt-2X™ mainline is incredibly smooth and supple.
- Featuring a unique lo-friction silicone-based coating to aid casting distance; this also improves line lay on the reel.
- The proven formula has remained unchanged, resulting in controlled elasticity and stretch, excellent abrasion resistance and superb knot strength.



CODE	LENGTH (M)	DIAMETER (MM)	BREAKING STRAIN (KG)	BREAKING STRAIN (LB)	GENCOD	TRADE PACK	RRP (€)
CELT-2X™ HI-VIS GREEN							
ACS470016	1600	0.26	7.0	15.5		3	26.49
ACS470017	1400	0.285	6.45	14.0		3	26.49
ACS470018	1200	0.31	7.60	16.5		3	26.49
ACS470019	1000	0.35	10.65	23.5		3	26.49

MAINLINE GREEN

- Good quality, low-viz green monofilament, which is also excellent value. Tried and tested, it features a super smooth finish for enhanced abrasion resistance and high knot strength. A great multi-purpose line to suit a range of fishing situations.
- Available in diameters 30, 35 and 40mm, on 1000m spools.



CODE	LENGTH (M)	DIAMETER (MM)	BREAKING STRAIN (KG)	BREAKING STRAIN (LB)	GENCOD	TRADE PACK	RRP (€)
CLASSIC MAINLINE GREEN							
ACS470083	1000	0.30	7.0	15.5		3	10.49
ACS470084	1000	0.35	9.5	21.0		3	12.49
ACS470085	1000	0.40	10.5	23.0		3	13.69

LINE REMOVER

- Perfect tool for quickly and effortlessly emptying high-capacity big pit reel spools.
- Removes line at up to 4 m/sec.
- High speed 2,700 rpm motor.
- Requires 4 x AA batteries (not included).



CODE	LENGTH (M)	BREAKING STRAIN (KG)	BREAKING STRAIN (LB)	GENCOD	TRADE PACK	RRP (€)
LINE REMOVER						
ACS010378	—	—	—		1	24.99



MT-X™

- M-TX™ is a good quality monofilament that's also excellent value.
- Features a super smooth finish for enhanced abrasion resistance and high knot strength.
- M-TX™ is available in both Green and Black colours to suit a range of fishing conditions.

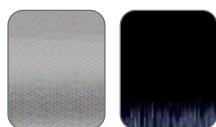

CODE	LENGTH (M)	DIAMETER (MM)	BREAKING STRAIN (KG)	BREAKING STRAIN (LB)	GENCOD	TRADE PACK	RRP (€)
MT-X™ BLACK							
ACS470058	1410	0.25	4.9	9.5		3	10.49
ACS470059	1410	0.28	5.9	11.0		3	10.49
ACS470060	1410	0.30	7.0	15.5		3	10.49
ACS470061	1020	0.35	9.5	21.0		3	10.49
ACS470062	790	0.40	10.5	23.0		3	10.49
NEW 2025 ACS470092	300	0.28	5.9	11.0		3	4.99
NEW 2025 ACS470093	300	0.30	7.0	15.5		3	4.99
NEW 2025 ACS470094	300	0.35	9.5	21.0		3	4.99
MT-X™ GREEN							
ACS470063	1410	0.30	7.0	15.5		3	10.49
ACS470064	1020	0.35	9.5	21.0		3	10.49
ACS470065	790	0.40	10.5	23.0		3	10.49

BRAIDED MAINLINE

4D – CAMO BRAID

- Made from Dyneema® / polyester blend resulting in a tremendous balance of value and performance.
- The 4 camouflage colours along its length help break up the shape to blend into the lakebed.
- Fast sinking, durable and highly abrasion resistant, the special twist construction provides exceptional sensitivity making 4D™ Camo Braid perfect for carp fishing.



CODE	LENGTH (M)	DIAMETER (MM)	BREAKING STRAIN (KG)	BREAKING STRAIN (LB)	GENCOD	TRADE PACK	RRP (€)
4D CAMO BRAID							
ACS640018	300	0.26	15.0	33.0		1	31.69
ACS640019	300	0.30	17.0	37.5		1	31.69
ACS640020	300	0.35	18.4	40.5		1	31.69
ACS640021	1000	0.26	15.0	33.0		1	91.99
ACS640022	1000	0.30	17.0	37.5		1	91.99
ACS640023	1000	0.35	18.4	40.5		1	91.99
ACS640095	3200	0.21	11.5	25.35		1	259.99
ACS640096	3200	0.26	15.0	33.0		1	259.99

SPOD & MARKER – BRAID

- Excellent value Hi-Viz braid, that is tough and durable to withstand the repetitive casting that spoding and feature finding requires.
- Zero stretch reduces 'springs back' when a spool line clip is used, and feedback is greatly enhanced when using a feature finding lead to map out the lake bed.



CODE	LENGTH (M)	DIAMETER (MM)	BREAKING STRAIN (KG)	BREAKING STRAIN (LB)	GENCOD	TRADE PACK	RRP (€)
SPOD & MARKER X4 – ORANGE							
ACS640097	300	0.16	11	24.25		1	36.49
SPOD & MARKER X4 – GREEN							
ACS640098	300	0.16	11	24.25		1	36.49

SHOCK LEADER

DRESSEN-X – SHOCKLEADER

- Made from a special polyamide copolymer, Dressen-X™ offers outstanding abrasion resistance against mussels, rocks, and gravel bars.
- It also retains a degree of stretch to help absorb the lunges during the crucial time of the when the fish is under the rod tip.



CODE	LENGTH (M)	DIAMETER (MM)	BREAKING STRAIN (KG)	BREAKING STRAIN (LB)	GENCOD	TRADE PACK	RRP (€)
DRESSEN-X – GREEN							
ACS470032	100	0.40	10.34	23.0		3	8.49
550048015	100	0.50	15.73	35.0		3	8.49
560048015	100	0.60	22.00	48.5		3	8.49
570048015	100	0.70	27.50	60.5		3	8.49
580048015	100	0.80	34.00	75.0		3	8.49
DRESSEN-X – CLEAR							
ACS470089	100	0.50	15.73	35.0		3	8.49
ACS470090	100	0.60	22.00	48.5		3	8.49
ACS470091	100	0.70	27.00	60.5		3	8.49

CASTING GLOVE – RIGHT HAND

- Made from thin and flexible neoprene making it exceptionally comfortable to wear.



CODE	LENGTH (M)	BREAKING STRAIN (KG)	BREAKING STRAIN (LB)	GENCOD	TRADE PACK	RRP (€)
CASTING GLOVE – RIGHT HAND						
ACS010381	—	—	—		1	12.49

BALLISTIC CAMO

NEW 2025

- Ballistic™ is an extremely strong and supple braid with neutral buoyancy and ultra-high abrasion resistance.
- Perfect for shock and snag leaders when fishing in extreme snaggy conditions.



CARP SPIRIT
MAINLINE
LEADERS &
HOOKLINKS

CODE	LENGTH (M)	BREAKING STRAIN (KG)	BREAKING STRAIN (LB)	GENCOD	TRADE PACK	RRP (€)
BALLISTIC CAMO						
ACS640100	100	11.30	25		3	29.99
ACS640101	100	15.90	35		3	29.99
ACS640102	100	20.40	45		3	29.99

4D-CAMO BRAIDED LINE SHOCK LEADER

NEW 2025

- Made from Dyneema®/polyester blend resulting in a tremendous balance of value and performance.
- The 4 camouflage colours along its length helps break-up the shape to blend into the lakebed.
- Fast sinking, durable and highly abrasion resistant, the special twist construction provides exceptional sensitivity making 4D™ Camo Braid perfect for carp fishing.



CODE	LENGTH (M)	DIAMETER (MM)	BREAKING STRAIN (KG)	BREAKING STRAIN (LB)	GENCOD	TRADE PACK	RRP (€)
4D-CAMO BRAIDED LINE SHOCK LEADER							
ACS640099	50	35	18.4	40.5		3	9.99

LEADCORE

GRAVITY UHL – HEAVY LEADCORE

- Gravity™ UHL is our heaviest leadcore leader.
- Perfect for fishing chod rigs, its super dense properties mean that there is no need for additional rig putty to ensure the leader is pinned down tight to the bottom.
- Easy to splice.







CODE	LENGTH (M)	BREAKING STRAIN (KG)	BREAKING STRAIN (LB)	GENCOD	TRADE PACK	RRP (€)
GRAVITY UHL CAMO GREEN						
ACS640045	10	20.40	45.0		3	15.79

GRAVITY – SPLICED LEADCORE LEADERS

- A full range of readymade Leadcore Leaders.
- Individually tested and carefully hand spliced.
- Made with our Gravity™ UHL leadcore.
- 3 per pack.



CODE	TYPE	LENGTH	BREAKING STRAIN (KG)	BREAKING STRAIN (LB)	GENCOD	TRADE PACK	RRP (€)
GRAVITY SPLICED LEADCORE LEADERS							
ACS010148	Loop to Swivel	90cm	—	—		5	5.49
ACS010149	Lead Clip	90cm	—	—		5	9.99
ACS010150	Metallic Lead Clip	90cm	—	—		5	9.49
ACS010151	Helicopter	90cm	—	—		5	9.99

HOOKLINKS

REACTION CAMO

NEW 2025

- Re-Action™ braid is a fast sinking, super soft, supple braid for hook lengths and particularly ideal for PVA bag presentation.
- Made from a blend of dyneema and polyester Re-Action™ has superb knot strength and abrasion resistance.



CODE	LENGTH (M)	BREAKING STRAIN (KG)	BREAKING STRAIN (LB)	GENCOD	TRADE PACK	RRP (€)
REACTION CAMO						
ACS640103	20	6.80	15		3	9.99
ACS640104	20	9.10	20		3	9.99
ACS640105	20	11.30	25		3	9.99
ACS640106	20	15.90	35		3	9.99

HERCULINE CAMO

NEW 2025

- Herculine™ blend is a slow sinking braid.
- This extremely soft hooklink is perfect for all rig presentations including super supple rigs to be used in solid PVA bags.



CODE	LENGTH (M)	BREAKING STRAIN (KG)	BREAKING STRAIN (LB)	GENCOD	TRADE PACK	RRP (€)
HERCULINE CAMO						
ACS640107	20	6.80	15		3	10.99
ACS640108	20	9.10	20		3	10.99
ACS640109	20	11.30	25		3	10.99

COMBI STIFF CAMO

NEW 2025

- A fast sinking, stiff coated braid, Combi-Stiff™ is particularly well suited to clean lake beds.
- Simply use a strip-eaze tool to remove the desired amount of coating to make the perfect combi or hinge style rigs.



CODE	LENGTH (M)	BREAKING STRAIN (KG)	BREAKING STRAIN (LB)	GENCOD	TRADE PACK	RRP (€)
COMBI-STIFF CAMO						
ACS640110	20	6.80	15		3	18.99
ACS640111	20	11.30	25		3	18.99

COMBI SOFT CAMO

NEW 2025

- A fast sinking, soft coated braid, ideal for combi link rigs or can be used un-stripped to create a semi rigid hooklink.
- Simply use a strip-eaze tool to remove the desired amount of coating to make the perfect combi or hinge style rigs.



CODE	LENGTH (M)	BREAKING STRAIN (KG)	BREAKING STRAIN (LB)	GENCOD	TRADE PACK	RRP (€)
COMBI-SOFT CAMO						
ACS640112	20	9.10	20		3	18.99
ACS640113	20	11.30	25		3	18.99
ACS640114	20	15.90	35		3	18.99



HOOKLINK BRAID

NEW 2025

- A great value braid made from 100% polyester.
- Ultra strong construction.
- Black/green fibre blend providing great camouflage.
- 25lb/11.3kg Breaking strain supplied a on 10m spool.



CODE	LENGTH (M)	BREAKING STRAIN (KG)	BREAKING STRAIN (LB)	GENCOD	TRADE PACK	RRP (€)
HOOKLINK BRAID						
ACS640115	10	11.30	25		3	4.99

OPTI-MEX – FLUOROCARBON HOOKLINK

- Opti-Mex™ is made from 100% fluorocarbon which due to its light refractive properties is virtually invisible in water and sinks 4 times faster compared to standard nylon line.
- With its low stretch and incredible abrasion resistance, Opti-Mex™ is the perfect choice for the most demanding of fishing situations that require the best possible presentation.



CODE	TYPE	LENGTH	BREAKING STRAIN (KG)	BREAKING STRAIN (LB)	GENCOD	TRADE PACK	RRP (€)
OPTI-MEX FLUOROCARBON							
ACS640039	—	20m	8.20	18.0		3	8.99
ACS640040	—	20m	10.50	23.0		3	9.99
ACS640041	—	20m	14.80	32.5		3	10.49
ACS640042	—	20m	17.00	37.5		3	12.99

CRIMPLING PLIERS

- Carbon steel pliers with comfortable grips, to finish Spinner or Fluoro rigs with crimps.
- Three diameter jaw options with markings to tighten double crimps - 0.6/0.7/0.8mm.



CODE	GENCOD	TRADE PACK	RRP (€)
CRIMPLING PLIERS			
ACS010406		5	15.59

DOUBLE CRIMPS

- Double crimps with a non-glare finish, designed to be used with the CS Crimping Pliers. Ideal for use with stiff booms.
- A choice of three diameters 0.6/0.7/0.8mm.

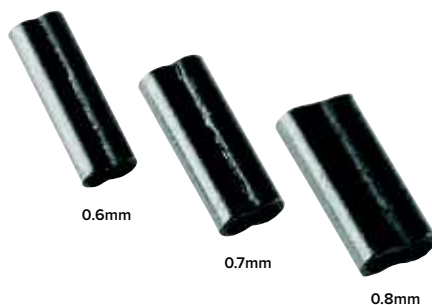

CODE	INNER DIAMETER (MM)	QUANTITY	GENCOD	TRADE PACK	RRP (€)
DOUBLE CRIMPS					
ACS010407	0.6	25		5	3.09
ACS010408	0.7	25		5	3.09
ACS010409	0.8	25		5	3.09

RIG TOOLS



HEAVY LIP CLOSE NEEDLE

- This 'all round' needle is suitable for most particle and boilie baits.
- The hinged gate securely holds the hair whilst sliding the bait up into position and is also a great little tool for tying small loops in short hairs.



CODE	GENCOD	TRADE PACK	RRP (€)
HEAVY LIP CLOSE NEEDLE			
ACS010264		5	4.69

FINE LIP CLOSE NEEDLE

- Designed for use with small boilies or soft baits, the fine wire hook greatly reduces the chance of splitting the bait.
- Also ideal for splicing leadcore or threading on fine silicone tubing onto braid.



CODE	GENCOD	TRADE PACK	RRP (€)
FINE LIP CLOSE NEEDLE			
ACS010265		5	4.69

STICK & STRING NEEDLE

- Designed primarily for threading hooklinks through PVA mesh sticks, the hinged gate closes to ensure that the hook does not catch or damage the mesh whilst pulling the needle through.
- Also perfect for making PVA stringers.



CODE	GENCOD	TRADE PACK	RRP (€)
STICK & STRING NEEDLE			
ACS010266		5	5.75



MAGGOT & ULTRA FINE BAIT NEEDLE

- Ideal for use with fine line or braided hairs, the ultra-fine pointed and hardened stainless steel needle reduces the chances of splitting fragile baits such as maggots or corn.



CODE	GENCOD	TRADE PACK	RRP (€)
MAGGOT & ULTRA FINE BAIT NEEDLE			
ACS010267		5	5.75

BAIT FLOSS

- Bait floss – An essential item that is perfect for tying on pop-ups.
- Perfect for tying on smooth and hard pop-ups.
- Flat profile and wax finish to grip baits securely.



CODE	LENGTH (M)	BREAKING STRAIN (KG)	BREAKING STRAIN (LB)	GENCOD	TRADE PACK	RRP (€)
BAIT FLOSS						
ACS010390	50	—	—		3	8.39

BAIT DRILL

- 1.2mm stainless steel drill
- Perfect for drilling out hard baits such as air-dried boilies or pellets.



CODE	DIAMETER (MM)	GENCOD	TRADE PACK	RRP (€)
BAIT DRILL				
ACS010268	1.2		5	5.75



BOILIE STOP

- Designed to fit snugly against the curved surface of any size of boilie, these discreet buoyant bait stops will securely hold the hair in place.

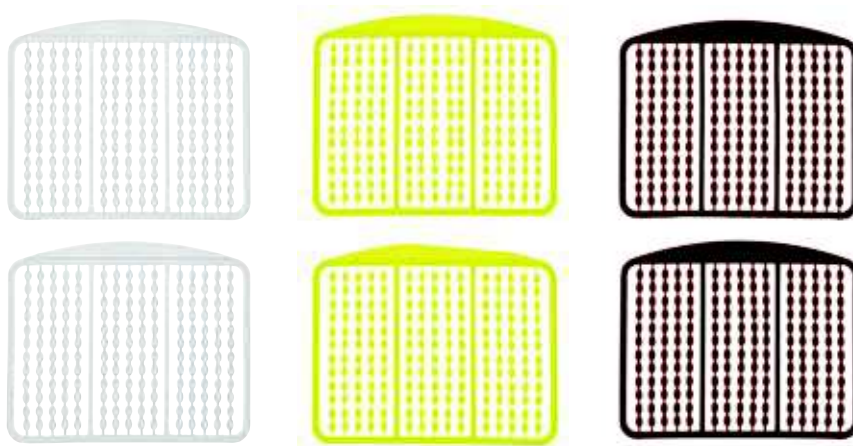

CODE	DIAMETER (MM)	COLOUR	QUANTITY	GENCOD	TRADE PACK	RRP (€)
BOILIE STOP						
ACS010278	—	Clear	180		5	3.65
ACS010279	—	Fluorescent Yellow	180		5	3.65
ACS010283	—	Brown	180		5	3.65

CORN BOILIE STOPS

- Floating imitation Corn Bait Stops provide an excellent visual aid when used with a boilie.
- The 2 hook lengths allow for that diameter of the boilie to be changed without having to change the length of the hair.



CODE	DIAMETER (MM)	COLOUR	QUANTITY	GENCOD	TRADE PACK	RRP (€)
CORN BOILIE STOPS						
ACS010011	—	Yellow	10 + 10		5	4.69

FLURO FLOATING CORN

- Floating imitation corn can be used either on its own or with real baits.
- Can also be soaked in liquid flavours for enhanced attraction.

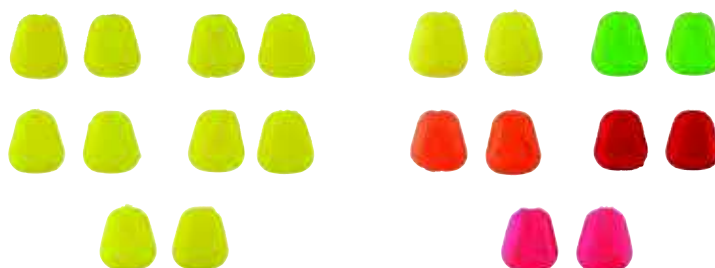

CODE	DIAMETER (MM)	COLOUR	QUANTITY	GENCOD	TRADE PACK	RRP (€)
FLURO FLOATING CORN						
ACS010096	—	Yellow	10		5	2.05
ACS010099	—	Assorted	10		5	2.05

BOILIE HAIR EXTENDER

- Designed to allow you to increase your hair length in seconds, perfect for fishing bigger baits or snowman style presentations without the need to re-tie your rig.
- Supplied on frames in 3 different lengths (4, 8, 12mm) for maximum versatility.



CODE	DIAMETER (MM)	COLOUR	QUANTITY	GENCOD	TRADE PACK	RRP (€)
BOILIE HAIR EXTENDER						
ACS010290	—	Clear	—		5	3.65

HAIR EXTENDER STOP

- Bait stop available in 3 different lengths to suit to different boilies diameters, without changing the hair length.

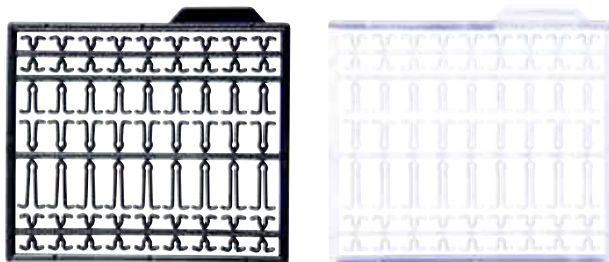

CODE	DIAMETER (MM)	COLOUR	QUANTITY	GENCOD	TRADE PACK	RRP (€)
HAIR EXTENDER STOP						
ACS010109	—	Black	—		5	3.65
ACS010110	—	Clear	—		5	3.65

BOILIE STOP CAPS

- These specially shaped Boilie Stop Caps are a discreet and neat alternative to traditional style stops hair stops.



CODE	DIAMETER (MM)	COLOUR	QUANTITY	GENCOD	TRADE PACK	RRP (€)
BOILIE STOP CAPS						
926000361	—	Assorted	—		5	3.65

STRIP-EAZE TOOL

- Ergonomically designed to fit comfortably between thumb and forefinger.
- The Strip-Eaze Tool has been designed to remove the outer coating safely and easily on combi style hooklinks without damaging the inner braid.



CODE	GENCOD	TRADE PACK	RRP (€)
STRIP-EAZE TOOL			
ACS010220		5	3.99



TERMINAL TACKLE, SWIVELS & LEADS

CARP SPIRIT | TERMINAL
TACKLE, SWIVELS
& LEADS

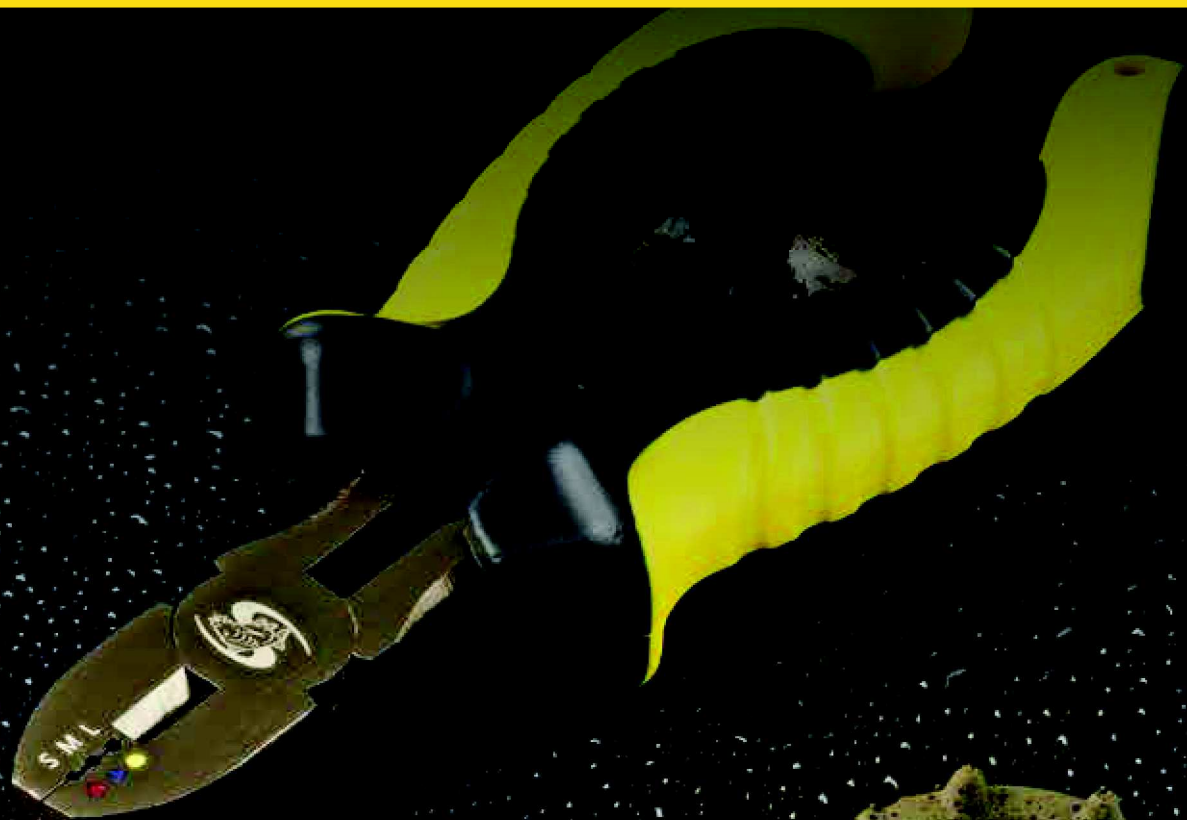

TERMINAL TACKLE

LEAD CLIPS PACK CAMO

- Probably the most popular method for attaching a lead with safety in mind.
- The force required to 'ditch' the lead is pre-determined by how far the tail rubber is pushed onto the clip.
- Each clip features a hole to accept the small pin to lock the swivel securely into the body (which is essential for the clip to work properly) but can be removed by using the supplied tool.



CODE	COLOUR	DIAMETER (MM)	QUANTITY	GENCOD	TRADE PACK	RRP (€)
LEAD CLIPS PACK CAMO						
ACS010410	Camo	—	10		5	6.75

METAL LEAD CLIPS CAMO PACK

NEW 2025

- Metal lead clip design to be used with a size 8 swivel.
- Ultra-resistant up to 350g for extreme fishing.
- Camouflage colouration.
- Pack includes: 10 metal lead clips and 10 tail rubbers.



CODE	COLOUR	DIAMETER (MM)	QUANTITY	GENCOD	TRADE PACK	RRP (€)
METAL LEAD CLIPS CAMO PACK						
ACS010446	Camo	—	10		5	7.89

LEAD CLIP TAIL RUBBERS CAMO

- Designed for to be used in conjunction with our Lead Clips and Rig Tube to create a neat and streamlined connection reducing tangles.



CODE	COLOUR	DIAMETER (MM)	QUANTITY	GENCOD	TRADE PACK	RRP (€)
LEAD CLIP TAIL RUBBERS CAMO						
ACS010412	Camo	—	10		5	4.49



SHRINK TUBE

- 3:1 shrink ratio, perfect for covering and protecting hook knots.
- Excellent shrink memory; you can create a range of shaped hook extensions and improve hooking efficiency.

Weed Green



CODE	COLOUR	DIAMETER (MM)	LENGTH	QUANTITY	GENCOD	TRADE PACK	RRP (€)
SHRINK TUBE							
ACS010254	Weed Green	1.2	5cm	10		5	2.49
ACS010255	Weed Green	1.6	5cm	10		5	2.49
ACS010256	Weed Green	2.4	5cm	10		5	2.49

SILICONE TUBE

- Essential for holding the hair securely in place on the hook shank, Silicone Tube will also help reduce tangles and aid hooking efficiency.

Weed Green



CODE	COLOUR	DIAMETER (MM)	LENGTH	QUANTITY	GENCOD	TRADE PACK	RRP (€)
SILICONE TUBE							
ACS010257	Weed Green	0.5	1.5m	—		5	2.49

LINE ALIGNER

- These pre-formed hook sleeves create the perfect Line Aligner every time.
- By having the hooklink exit the front of the hook, the turning effect and efficiency of the rig is increased.
- A more aggressive hook angle is also created, making the rig harder to eject.

Camfusion®



Weed Green



ACS010364 - 6/8
ACS010365 - 2/4
ACS010126 - 6/8
ACS010127 - 2/4

CODE	COLOUR	DIAMETER (MM)	LENGTH	QUANTITY	GENCOD	TRADE PACK	RRP (€)
LINE ALIGNER							
ACS010364	Camfusion	—	—	15		5	4.89
ACS010365	Camfusion	—	—	15		5	4.89
ACS010126	Weed Green	—	—	15		5	4.89
ACS010127	Weed Green	—	—	15		5	4.89

TUNGSTEN HOOKLINK WEIGHTS

- Tungsten Hooklink Weights are perfect pinning down the hooklink to improve rig presentation.

Khaki



CODE	COLOUR	DIAMETER (MM)	LENGTH	QUANTITY	GENCOD	TRADE PACK	RRP (€)
TUNGSTEN HOOKLINK WEIGHTS							
ACS010121 (Std)	Khaki	—	—	15		5	5.49

TUNGSTEN TUBE

- Extremely dense rig tube to keep the mainline pinned down tight to the lakebed.
- Length – 2m
- Internal Diameter – 0.6mm
- External Diameter – 1.85mm



CODE	COLOUR	DIAMETER (MM)	LENGTH	QUANTITY	GENCOD	TRADE PACK	RRP (€)
TUNGSTEN TUBE							
ACS010045	Please see product for specification					5	12.09

TUNGSTEN PUTTY

- High quality Tungsten Putty that can be moulded directly onto hooklinks to counterbalance pop-ups or to make critically balanced baits.
- Top Tip: to make application and shaping easy, simply roll a small piece of putty between the hands to soften.
- Weight – 20g.



CODE	COLOUR	DIAMETER (MM)	LENGTH	QUANTITY	GENCOD	TRADE PACK	RRP (€)
TUNGSTEN PUTTY							
ACS010051	Dark Green	—	—	—		5	13.19
ACS010052	Dark Brown	—	—	—		5	13.19

MAGGOT CLIP

- Maggots have long been one of the most effective baits for carp and this bait clip is the perfect solution to fish them on a hair rig.
- Quick and simple to use, simply unclip the point, thread the maggots on and close the clip.



CODE	COLOUR	QUANTITY	GENCOD	TRADE PACK	RRP (€)
MAGGOT CLIP					
ACS010152	—	20		10	6.49

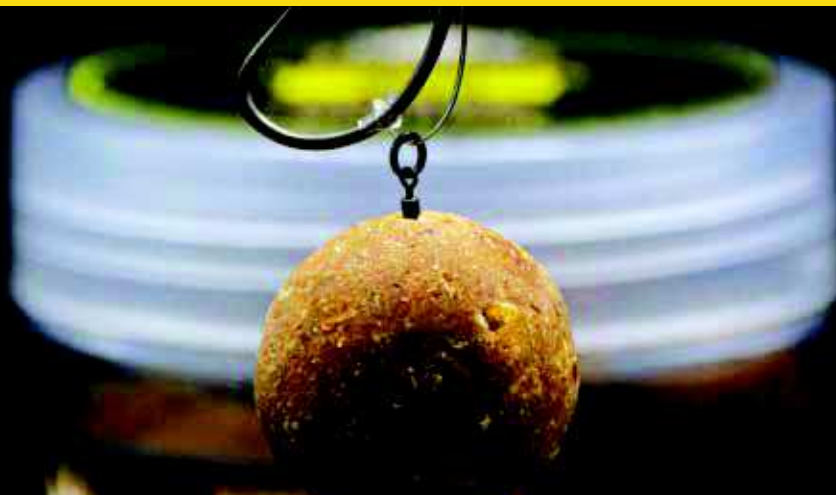

HOOK RIG STOP

- Designed to create various anti-eject, sliding and 360 rigs by easily be sliding onto the hook shank.
- The rubber used is hard enough to stay put on the cast but will move easily when the hook point penetrates the mouth of a fish.
- Use in conjunction with our Pop-Up Pegs to create a very easy but awesome Pop-Up Rig.



CODE	COLOUR	QUANTITY	GENCOD	TRADE PACK	RRP (€)
HOOK RIG STOP					
ACS010297	—	50		5	5.59

RIG RING STOP

- Rig Ring Stops are silicone beads that can be threaded onto the hook shank either side of a rig ring to secure it in place, perfect for making 'D' rigs.
- The special shape ensures the ring does not get trapped and is free to move along the hook shank.

Clear



Khaki



CODE	COLOUR	QUANTITY	GENCOD	TRADE PACK	RRP (€)
RIG RING STOP					
ACS010056	Clear	10		5	2.79
ACS010177	Khaki	10		5	2.79

ASSORTED BAIT BAND

- Bait Bands have a variety of uses and are useful to mount hard baits such as pellets and mixers directly onto the hook shank or for making 'D' rigs.



CODE	COLOUR	QUANTITY	GENCOD	TRADE PACK	RRP (€)
ASSORTED BAIT BANDS					
ACS010101	Clear & Brown	45		5	2.79



D-RIG POP-UP PIN

- These stainless-steel pins are perfect for making 'D' Rigs.
- Simply insert the pin into the boilie, the barb will ensure the bait stays on even during long casts and the ring can be secured on the hook shank with a rig stop either side.
- Recommended for hard or air-dried baits.



CODE	COLOUR	QUANTITY	GENCOD	TRADE PACK	RRP (€)
D-RIG POP-UP PIN					
ACS010422	—	10		5	5.15

POP-UP PEGS

- Quick and simple to use, simply screw on your pop-up.
- The base ensures water does not penetrate the pop-up and prevent the bait from swelling up over the ring.
- The screw thread provides exceptional grip to ensure the bait does not come off during the cast.



CODE	COLOUR	QUANTITY	GENCOD	TRADE PACK	RRP (€)
POP-UP PEGS					
ACS010284	Clear	20		5	5.19



VLAD PAVLOVICI 

BOILIE NEEDLE



CODE	COLOUR	QUANTITY	GENCOD	TRADE PACK	RRP (€)
BOILIE NEEDLE					
140900360	—	1		5	1.89

SEED NEEDLE

- Short reinforced shaft to hook hard baits.



CODE	COLOUR	QUANTITY	GENCOD	TRADE PACK	RRP (€)
BOILIE NEEDLE					
141000360	—	1		5	1.99

NEEDLE KIT

- Pack of 3 needles including: 1 x Boilie Needle, 1 x PVA Needle and 1 x Seed Needle.

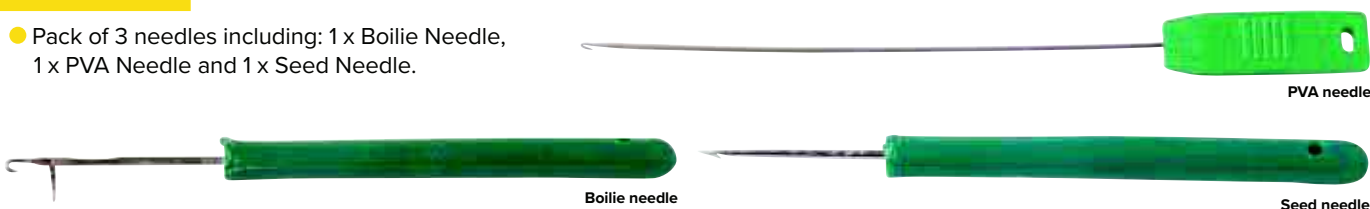

CODE	COLOUR	QUANTITY	GENCOD	TRADE PACK	RRP (€)
NEEDLE KIT					
ACC100000	—	1		5	5.19

BOILIE STOPS

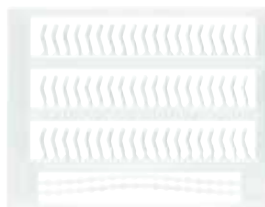

CODE	COLOUR	QUANTITY	GENCOD	TRADE PACK	RRP (€)
BOILIE STOPS					
141700360	Clear	1		5	1.59

BOILIE STOPS PACK

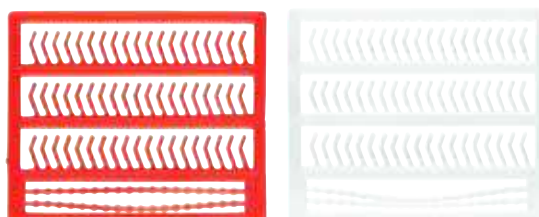

CODE	COLOUR	QUANTITY	GENCOD	TRADE PACK	RRP (€)
BOILIE STOPS PACK					
141800360	Orange & Clear	1		5	2.49

ANTI-TANGLE RIGID BENT



CODE	COLOUR	QUANTITY	GENCOD	TRADE PACK	RRP (€)
ANTI-TANGLE RIGID BENT					
139200360	Black	3		5	1.85

ANTI-TANGLE CLIPS

- Its rigid and flexible anti-tangles will release the lead if the carp is hooked in the branches.



CODE	COLOUR	LENGTH (CM)	QUANTITY	GENCOD	TRADE PACK	RRP (€)
ANTI-TANGLE CLIPS						
ACC010027	Black	7	3		5	1.95
ACC010028	Black	25	3		5	1.95
ACC010029	Black	40	3		5	2.25

SPRING CAGE FEEDER XL

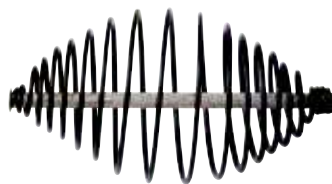

CODE	COLOUR	QUANTITY	GENCOD	TRADE PACK	RRP (€)
SPRING CAGE FEEDER XL					
141900360	Black	1		5	2.59

SPRING CAGE FEEDER



CODE	COLOUR	QUANTITY	GENCOD	TRADE PACK	RRP (€)
SPRING CAGE FEEDER					
142000360	Black	1		5	2.59

SPRING CAGE FEEDER WITH LEAD



CODE	COLOUR	QUANTITY	GENCOD	TRADE PACK	RRP (€)
SPRING CAGE FEEDER WITH LEAD					
142100360	Black	1		5	3.09

SWIVELS

ROLLING SWIVEL

- Available in a range of sizes, they are perfectly formed and have a dull, non-reflective, matt-black finish to prevent spooking the fish.



No. 8



No. 11

CODE	SIZE NO.	DIAMETER (MM)	SHAPE	QUANTITY	GENCOD	TRADE PACK	RRP (€)
ROLLING SWIVEL							
ACS290004	08	—	—	10		5	2.79
ACS290003	11	—	—	10		5	2.79

MICRO ROLLING SWIVEL

- Micro rolling in size 20 for the realization of D-Rig.
- These practical swivels have a dull, non-reflective, matt-black finish to prevent spooking the fish.



No. 20

CODE	SIZE NO.	DIAMETER (MM)	SHAPE	QUANTITY	GENCOD	TRADE PACK	RRP (€)
MICRO ROLLING SWIVEL							
ACS290023	20	—	—	10		5	2.29

ROLLING SWIVEL WITH RING

- Originally designed for creating the highest degree of flexibility between your mainline and hook link, they are incredibly versatile, allowing you to create a multitude of bottom, pop-up and zig rigs.



No. 8



No. 11

CODE	SIZE NO.	DIAMETER (MM)	SHAPE	QUANTITY	GENCOD	TRADE PACK	RRP (€)
ROLLING SWIVEL WITH RING							
ACS290007	08	—	—	10		5	4.15
ACS290006	11	—	—	10		5	4.15

MICRO ROLLING SWIVEL WITH RING

- Micro rolling in size 20 for the realization of D-Rig.
- These practical swivels have a dull, non-reflective, matt-black finish to prevent spooking the fish.



No. 20

CODE	SIZE NO.	DIAMETER (MM)	SHAPE	QUANTITY	GENCOD	TRADE PACK	RRP (€)
MICRO ROLLING SWIVEL WITH RING							
ACS290024	20	—	—	10		5	3.95

ROLLING SWIVEL WITH SPEED LINK

- High quality swivels with a pre fitted speed link for quick change of terminal tackle and hooklinks.
- Perfectly formed featuring a dull, non-reflective, matt-black finish to prevent spooking the fish.



CODE	SIZE NO.	DIAMETER (MM)	SHAPE	QUANTITY	GENCOD	TRADE PACK	RRP (€)
ROLLING SWIVEL WITH SPEED LINK							
ACS290013	—	—	—	10		5	4.49

QC ROLLING SWIVEL

- QC Swivels are designed for a quick change of hook links without having to cut line and re-tie knots.
- Perfect when fishing with PVA sticks, when the hook link needs to be drawn through the stick and then clipped on to the swivel, simply slide over a tail rubber to keep everything neat.



CODE	SIZE NO.	DIAMETER (MM)	SHAPE	QUANTITY	GENCOD	TRADE PACK	RRP (€)
QC ROLLING SWIVEL							
ACS290011	08	—	—	10		5	4.49

QC ROLLING SWIVEL WITH RING

- Instantly replace a hook link or lead without having to re-tie rigs, these swivels also feature an additional ring that makes them incredibly flexible.
- Perfect swivels to use when fishing hinged stiff rigs.



CODE	SIZE NO.	DIAMETER (MM)	SHAPE	QUANTITY	GENCOD	TRADE PACK	RRP (€)
QC ROLLING SWIVEL WITH RING							
ACS290012	08	—	—	10		5	4.49

QUICK LOCK SWIVEL

- Quick Lock Swivels are quick and easy to use.
- Looped hooklinks can be attached and removed quickly and effortlessly, ideal for PVA sticks and PVA bags where the hooklink needs to be removed.



CODE	SIZE NO.	DIAMETER (MM)	SHAPE	QUANTITY	GENCOD	TRADE PACK	RRP (€)
QUICK LOCK SWIVEL							
ACS290002	—	—	—	5		5	5.49

SPINNER RIG SWIVEL + RING

- A quick change purposely designed swivel to create the Spinner rig/Ronnie rig.
- Use a small piece of shrink tube to cover the connection and to keep the hook at the correct angle.
- Each swivel has a dull, non-glare, matt black finish to prevent the fish being spooked.



CODE	SIZE NO.	DIAMETER (MM)	SHAPE	QUANTITY	GENCOD	TRADE PACK	RRP (€)
QUICK CLIP							
ACS290025	—	—	—	10		5	6.29

QUICK CLIP

- Quick Clips have a multitude of uses and are ideal for quick change of many terminal tackle parts and rigs.



CODE	SIZE NO.	DIAMETER (MM)	SHAPE	QUANTITY	GENCOD	TRADE PACK	RRP (€)
QUICK CLIP							
ACS290008	—	—	—	10		5	3.45

ROUND RINGS

- Perfect for creating 'D' rigs or 360 style rigs by threading onto the hook shank and securing in place with our hook rig stops.



CODE	SIZE NO.	DIAMETER (MM)	SHAPE	QUANTITY	GENCOD	TRADE PACK	RRP (€)
RINGS							
ACS290015	—	3.7	Round	10		5	2.39



LUCA HEUER
@luca_hh_offishal

LEADS

A range of leads with three different shapes to suit most angling situations. Super durable, matte, low visibility coating, combined matte swivels making them ideal for fishing in clear waters. The swivels also have an oversized eyelet for use with lead clips.



DISTANCE IN-LINE CAMO NEW 2025

- Inline design for maximum hooking potential.
- A great shape to reach maximum casting distance.
- Flat sides prevent roll in the current.
- Camouflage outer coating.
- Inner tube has the perfect diameter to accept a size 8 swivel.



CODE	QUANTITY	WEIGHT (G)	WEIGHT (OZ)	GENCOD	TRADE PACK	RRP (€)
DISTANCE IN-LINE CAMO						
ACS550204	Bulk	50	1.80		10	2.09
ACS550205	Bulk	70	2.45		10	2.69
ACS550206	Bulk	85	3.00		10	2.99
ACS550207	Bulk	100	3.50		10	3.29
ACS550208	Bulk	120	4.20		10	3.69



DISTANCE CAMO

- The perfect shape to reach the maximum casting distances.



CODE	QUANTITY	WEIGHT (G)	WEIGHT (OZ)	GENCOD	TRADE PACK	RRP (€)
DISTANCE CAMO						
ACS550186	Bulk	70	2.45		10	2.59
ACS550187	Bulk	85	3.00		10	2.89
ACS550188	Bulk	100	3.50		10	2.99
ACS550189	Bulk	115	4.05		10	3.19
ACS550190	Bulk	130	4.60		10	3.49
ACS550191	Bulk	150	5.30		10	3.79

RIVER CAMO

- Flat design with a hollow centre, finished with gripping nodules. Particularly suited to river fishing or when casting onto steep features.



CODE	QUANTITY	WEIGHT (G)	WEIGHT (OZ)	GENCOD	TRADE PACK	RRP (€)
RIVER CAMO						
ACS550192	Bulk	110	3.90		10	3.09
ACS550193	Bulk	145	5.10		10	3.69
ACS550194	Bulk	180	6.30		10	4.19
ACS550195	Bulk	215	7.55		10	4.69
ACS550196	Bulk	250	8.80		10	5.49

PEAR CAMO

- Multiple application shape for many different fishing situations.

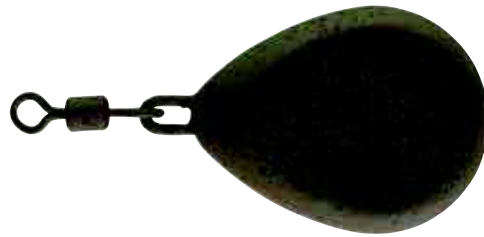

CODE	QUANTITY	WEIGHT (G)	WEIGHT (OZ)	GENCOD	TRADE PACK	RRP (€)
PEAR CAMO						
ACS550197	Bulk	55	1.90		10	2.29
ACS550198	Bulk	70	2.45		10	2.59
ACS550199	Bulk	85	3.00		10	2.89
ACS550200	Bulk	100	3.50		10	3.09
ACS550201	Bulk	115	4.05		10	3.19

DISTANCE

- These torpedo shaped leads are ideal for long range casting and provide extreme accuracy to.
- Coated with impact resistant rubber and pad printed to easily identify the weight.



CODE	QUANTITY	WEIGHT (G)	WEIGHT (OZ)	GENCOD	TRADE PACK	RRP (€)
DISTANCE						
ACS550030	Bulk	50	1.80		12	1.99
115960361	Bulk	60	2.10		12	1.99
257070361	Bulk	70	2.45		12	1.99
ACS550032	Bulk	80	2.80		12	1.99
258090361	Bulk	90	3.15		12	2.59
259100361	Bulk	100	3.50		12	2.59
260110361	Bulk	110	3.90		12	2.59
261130361	Bulk	130	4.60		12	3.19
262150361	Bulk	150	5.30		12	3.19

TRILOBE

- Excellent for distance, the special flat sides and grooves help prevent rolling off and will help rapid rising to the surface during retrieval.
- Coated with impact resistant rubber and pad printed to easily identify the weight.



CODE	QUANTITY	WEIGHT (G)	WEIGHT (OZ)	GENCOD	TRADE PACK	RRP (€)
TRILOBE						
ACS550034	Bulk	50	1.80		12	1.99
116060361	Bulk	60	2.10		12	1.99
269070361	Bulk	70	2.45		12	1.99
ACS550036	Bulk	80	2.80		12	1.99
270090361	Bulk	90	3.15		12	2.59
271100361	Bulk	100	3.50		12	2.59
272110361	Bulk	110	3.90		12	2.59

FEATURE FINDING LEAD

- These specialist leads feature four 'probes' which when dragged back along the bottom help to transmit feeling and vibration through the rod tip.



CODE	WEIGHT (G)	WEIGHT (OZ)	QUANTITY	GENCOD	TRADE PACK	RRP (€)
FEATURE FINDING LEAD						
ACS550101	112	4	1		3	5.09
ACS550102	140	5	1		3	6.19

BACK LEAD

- Flat based and cone shaped, these Back Leads are perfect for sinking your mainline under the rod tip. Supplied with a low friction clip.



CODE	WEIGHT (G)	WEIGHT (OZ)	QUANTITY	GENCOD	TRADE PACK	RRP (€)
BACK LEAD						
ACS550000	20	0.70	1		5	2.19
ACS550021	40	1.40	1		5	2.69

BACK LEAD CLIPS

- Perfect for use with our Back Lead Discs.
- Simply hook onto the Back Lead Disc and slide the sleeve over.
- The large loop then can be clipped onto the mainline to sink your mainline under the rod tip.



CODE	WEIGHT (G)	WEIGHT (OZ)	QUANTITY	GENCOD	TRADE PACK	RRP (€)
BACK LEAD CLIPS						
ACS010130	—	—	5		5	2.99

METHOD FEEDER

- High quality moulded Method Feeder.
- The 3-fin design features a weight on one side only so that the hook bait can be positioned on the opposite side to ensure the bait is presented perfectly every time.



CODE	WEIGHT (G)	WEIGHT (OZ)	QUANTITY	GENCOD	TRADE PACK	RRP (€)
METHOD FEEDER						
130040360	40	1.40	1		5	4.39
ACS550202	60	2.10	1		5	5.19
ACS550203	80	2.8	1		5	6.19

SOLURON PVA



SOLURON PVA TUBE

- The tube features a tight, anti-ladder mesh construction and the flared funnel loader makes loading of bait quick and simple with reduced spillages.
- Soluron PVA tube is perfect for stick mixes, chopped boilies, ground bait, maggots and more.
- Once empty, tube re-filler spools can be purchased separately.
- 7m PVA tube on a pre-loaded flared funnel.
- 1x plunger included, 1x sealed storage tube.
- Breakdown time approx. 2 minutes in water at 20°C.
- Available in three sizes: 30mm, 22mm and 14mm.



CODE	LENGTH (M)	DIAMETER (MM)	SIZE	QUANTITY	GENCOD	TRADE PACK	RRP (€)
SOLURON PVA TUBE							
ACS010423	7	14	—	1		5	11.49
ACS010424	7	22	—	1		5	11.49
ACS010425	7	30	—	1		5	11.49

SOLURON PVA TUBE REFILL

- Soluron PVA tube refill spools are perfect for anglers who already have Soluron plungers and funnels.
- Breakdown time approx. 2 minutes in water at 20°C
- Refill spools are available in 5m and in the following sizes: 30mm, 22mm and 14mm.



CODE	LENGTH (M)	DIAMETER (MM)	SIZE	QUANTITY	GENCOD	TRADE PACK	RRP (€)
SOLURON PVA TUBE REFILL							
ACS010058	5	14	—	1		5	8.49
ACS010059	5	22	—	1		5	8.49
ACS010060	5	30	—	1		5	8.49

SOLURON PVA STRING

- Soluron PVA String is incredibly versatile.
- Perfect for tying off PVA Bags, stringing boilies or even tying back rigs for distance casting.



CODE	LENGTH (M)	DIAMETER (MM)	SIZE	QUANTITY	GENCOD	TRADE PACK	RRP (€)
SOLURON PVA STRING							
151500361	20	—	L	1		5	2.65

SOLURON PVA BAG FAST

- Made from high quality PVA film, these bags are tough and not likely to tear or split. Low residue formula for improved presentation.
- Two version with different dissolving times:
- Fast Melt - for cold water conditions, ideal for late Autumn, Winter and early Spring use.



CODE	DIMENSIONS (MM) (W x H)	QUANTITY	GENCOD	TRADE PACK	RRP (€)
SOLURON PVA BAG FAST					
ACS010426	60 x 120	15		5	3.09
ACS010427	70 x 150	15		5	3.09
ACS010428	85 x 150	15		5	3.09

SOLURON PVA BAG SLOW

- Made from high quality PVA film, these bags are tough and not likely to tear or split. Low residue formula for improved presentation.
- Two version with different dissolving times:
- Slow Melt - for warm water conditions, best used from late Spring to early Autumn. Also ideal for use in deeper waters, to avoid the bag melting before it hits the lake or river bed.



CODE	DIMENSIONS (MM) (W x H)	QUANTITY	GENCOD	TRADE PACK	RRP (€)
SOLURON PVA BAG SLOW					
ACS010429	60 x 120	15		5	3.09
ACS010430	70 x 150	15		5	3.09
ACS010431	85 x 150	15		5	3.09

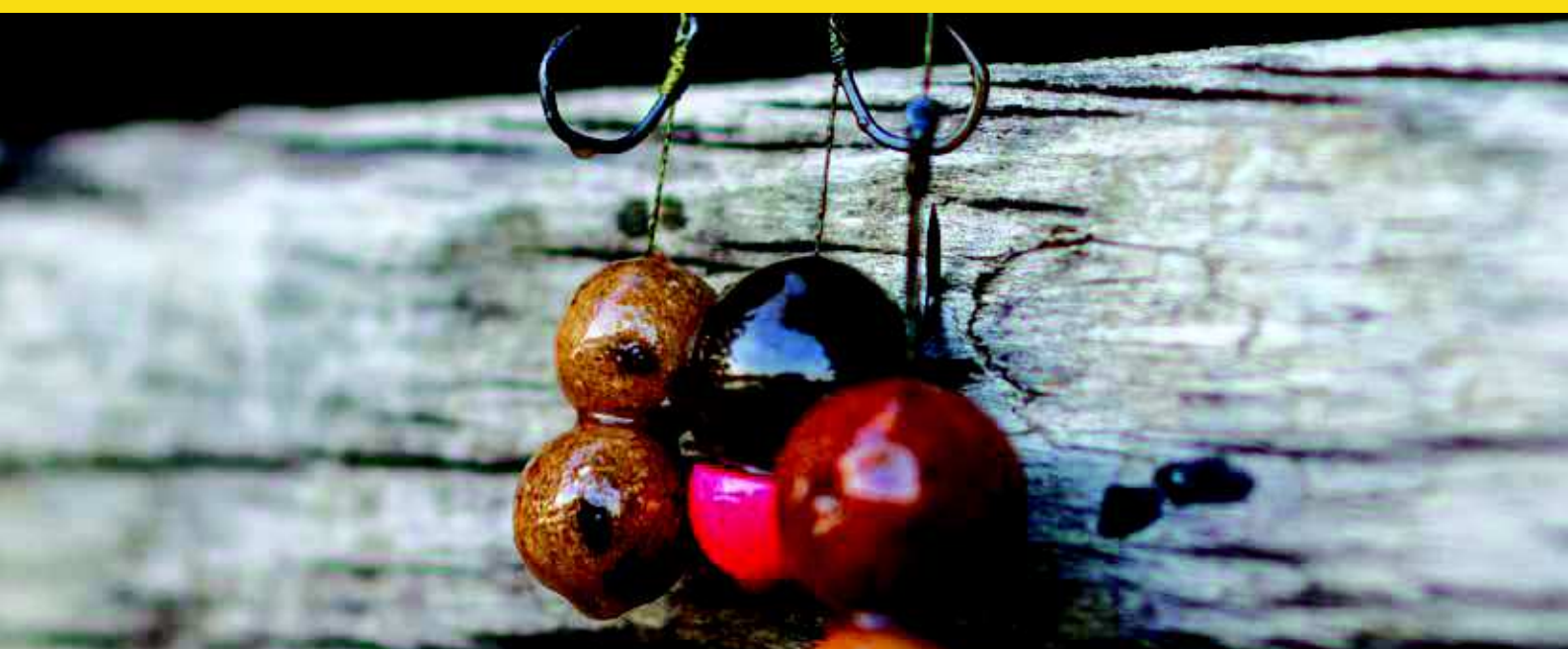

SOLURON PVA LOADER STARTER PACK

- 2 sizes of loader, and closing rings supplied.
- Matching PVA bags included.
- Perfect fit and easy loading every time.
- Spare Bags to match available: Size 1 x 10 and Size 2 x 10.



CODE	LENGTH (MM)	WIDTH (MM)	SIZE	QUANTITY	GENCOD	TRADE PACK	RRP (€)
SOLURON PVA LOADER STARTER PACK							
ACS010215	—	—	M+L Shovel	20		5	7.99

SOLURON LOADER BAGS

- Spare Bags to match with the PVA Loader.



CODE	LENGTH (MM)	WIDTH (MM)	SIZE	QUANTITY	GENCOD	TRADE PACK	RRP (€)
LOADER BAGS							
ACS010216	—	—	1	20		5	4.15
ACS010217	—	—	2	20		5	4.15

SOLURON PVA BAG FUNNEL LOADER

- This funnel loader makes the task of loading up PVA bags quick and simple with a large open top to reduce spillage.
- It features a full length slit down the side so that the hooklink can easily be removed after loading.
- Hi-Viz Yellow colour.



CODE	LENGTH (MM)	WIDTH (MM)	SIZE	QUANTITY	GENCOD	TRADE PACK	RRP (€)
SOLURON PVA BAG FUNNEL LOADER							
ACS010159	—	—	—	—		3	4.15



SHRINK WRAP BOILIE GUARD

- Simply place a piece of protector over the boilie and then shrink down tight using kettle steam.
- The premade holes still allow the flavour to leak out from the hookbait.
- Available in 2 sizes: 15/20mm and 20/25mm.



CODE	LENGTH (MM)	WIDTH (MM)	SIZE	QUANTITY	GENCOD	TRADE PACK	RRP (€)
SHRINK WRAP BOILIE GUARD							
845000361	—	15 & 20	—	10		5	5.19
846000361	—	20 & 25	—	10		5	5.69



BAITING UP

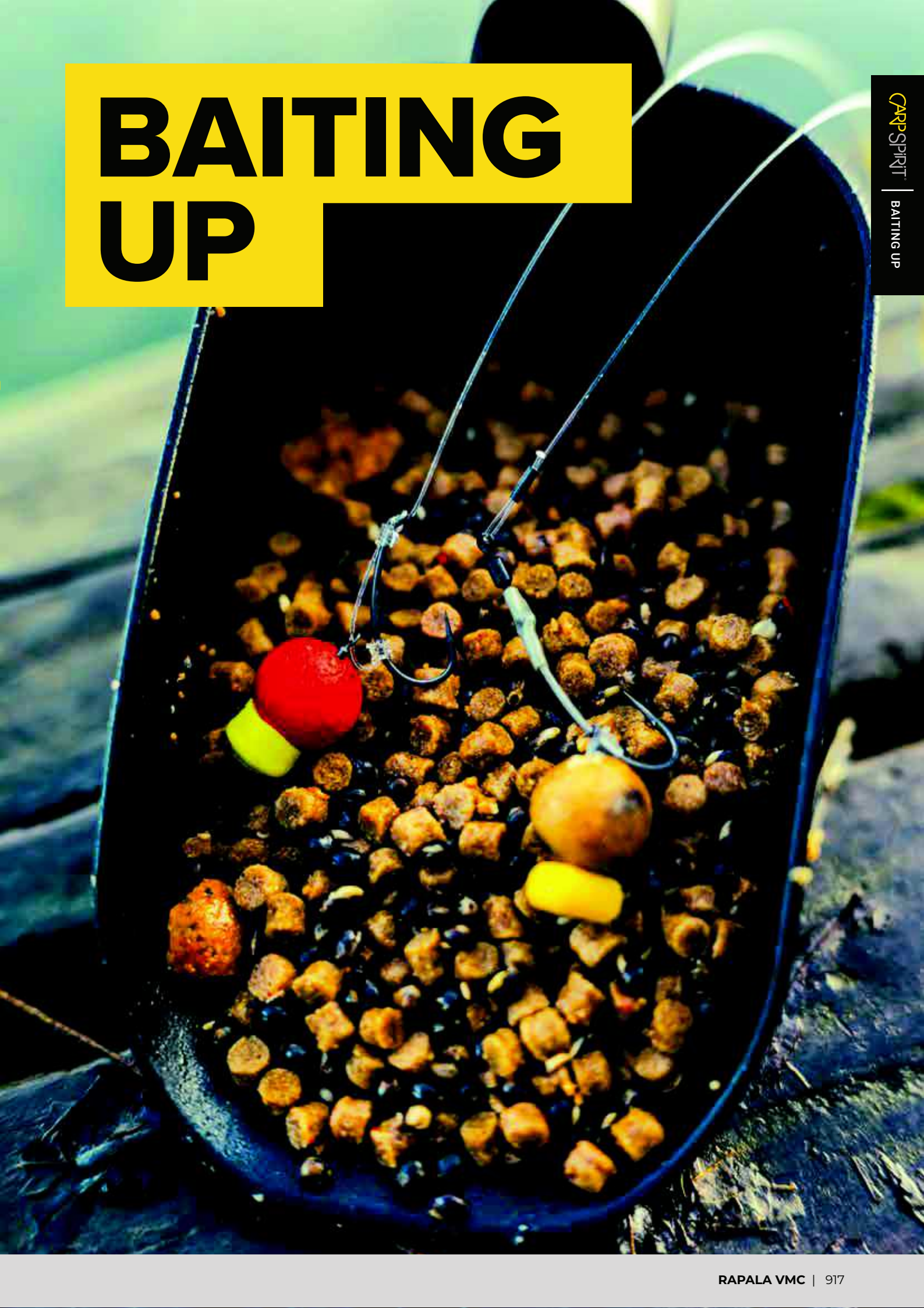

MAGNUM THROWING STICK

- Made from 3K carbon fibre, not only is it extremely accurate, but with its ultra-light construction helps avoid arm and shoulder strain, particularly when baiting heavily. Easy grip handle to avoid the throwing stick twisting whilst in use and finished with a wrist retaining strap. Supplied in a Neoprene case.

Available in 3 sizes:

- The XLarge, Long Distance version is designed for long distances or larger baits and is 35% longer than the existing model. This extra length helps to propel the boilies up to 20m further than a standard length throwing stick.
- XLarge - For boilies up to 26mm.
- Large - For boilies up to 22mm.



Long Distance Version

CODE	WEIGHT (GR)	FOR BAITS UP TO (MM)	GENCOD	TRADE PACK	RRP (€)
MAGNUM THROWING STICK					
NEW 2025 ACS010447 (Long Distance)	135	26		1	109.99
ACS010433 (XL)	122	26		1	98.99
ACS010432 (L)	118	22		1	93.99

BLAX ALUMINIUM THROWING STICK

NEW 2025

- Aluminium construction.
- Designed for boilies up to 22mm.
- Handle with a secure strap.



CODE	WEIGHT (GR)	FOR BAITS UP TO (MM)	GENCOD	TRADE PACK	RRP (€)
BLAX ALUMINIUM THROWING STICK					
ACS010448	142	22		1	14.99

BLAX PVC THROWING STICK

NEW 2025

- PVC construction.
- Designed for boilies up to 22mm.
- Handle with a secure strap.



CODE	WEIGHT (GR)	FOR BAITS UP TO (MM)	GENCOD	TRADE PACK	RRP (€)
BLAX PVC THROWING STICK					
ACS010449	155	22		1	12.99

CATAPULT

CODE	GENCOD	TRADE PACK	RRP (€)
CATAPULT			
142300360		3	7.09

DISTANCE STICKS

- Designed to easily measure your fishing distance, aiding consistent accurate casting.
- Comprises of two black anodized aluminium 60cm banksticks, with very strong tops so they can be hammered into the ground or you can utilise the auger points so they can be screwed-in instead. An additional practical feature is the reflective tape around the top, making them very easy to be used at night.
- Supplied with a spacing cord and carrying bag.

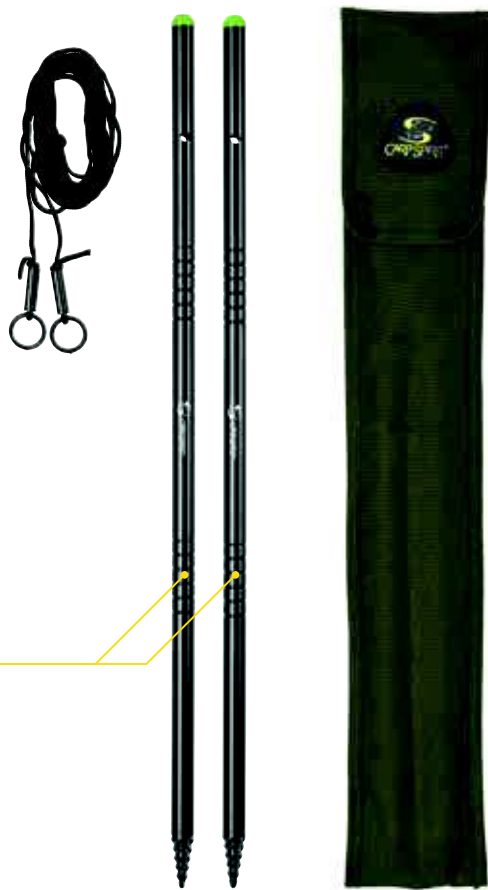

Grooves

CODE	WEIGHT (KG)	LENGTH (CM)	GENCOD	TRADE PACK	RRP (€)
DISTANCE STICKS					
ACS010441	0.30	60		1	17.99



BAITING SHOVEL

- Lightweight baiting shovel with carbon sleeve.
- Screwed-head for space-saving.
- Reinforced handle EVA.



CODE	WEIGHT (G / KG)	FOR BAITS UP TO (MM)	LENGTH (CM)	COLOUR	GENCOD	TRADE PACK	RRP (€)
BAITING SHOVEL							
ACS010161	—	—	—	—		1	23.29

BAITING HANDLE + SCOOP

NEW 2025

- Perfect for baiting from the bank or from the boat.
- Handle: made from ultra-strong fibreglass featuring dual grips.
- Scoop: made from ultra-strong moulded ABS.



CODE	WEIGHT (G / KG)	FOR BAITS UP TO (MM)	LENGTH (CM)	COLOUR	GENCOD	TRADE PACK	RRP (€)
BAITING HANDLE + SCOOP							
ACS010450	—	—	35	Black		1	12.99

ONE PIECE SCOOP

- Made from ultra-strong moulded ABS this simple and economical one-piece scoop is perfect for baiting up from the boat.



CODE	WEIGHT (G / KG)	FOR BAITS UP TO (MM)	LENGTH (CM)	COLOUR	GENCOD	TRADE PACK	RRP (€)
ONE PIECE SCOOP							
ACS010438	—	—	—	Black		5	6.29



SQUARE BUCKET

- Square shaped moulded bait bucket that helps maximise space. Perfect for transporting boilies, seeds, and pellets in both wet or dry states.
- Transparent cover to see the baits and a strong handle complete with grip.
- Two models - 10L and 17L.



CODE	CAPACITY (L)	DIAMETER (MM)	DIMENSIONS (CM)	GENCOD	TRADE PACK	RRP (€)
SQUARE BUCKET						
ACS010442	10	—	—		1	13.49
ACS010443	17	—	—		1	15.59

TRIPOD SQUARE BUCKET STAND

- Designed for use when spodding, particularly useful when applying large quantities of bait. The design also aids accuracy, helping to avoid constantly moving position when reloading the spod. Best used with square or rectangular bucket.
- Made from a black coated steel frame, combined with adjustable legs and a support for a rod, shovel or towel. Supplied in its own carry case.
- The ideal partner for the Carp Spirit 10 and 17L Square Buckets.



CODE	DIMENSIONS (CM)	GENCOD	TRADE PACK	RRP (€)
TRIPOD SQUARE BUCKET STAND				
ACS010444	31x27.5		1	62.99

BUCKET

- High quality moulded bait bucket, perfect for transporting boilies, seeds, and pellets in both wet and dry states.
- 18 litre capacity.



CODE	CAPACITY (L)	DIAMETER (MM)	DIMENSIONS (CM)	GENCOD	TRADE PACK	RRP (€)
BUCKET						
ACS010372	18	—	—		1	11.49

TRIPOD BUCKET STAND

- Fully adjustable height from 0.9 to 1.3 meters.
- Removable legs.
- Lightweight Aluminium.
- Sold without bucket.
- Weight - 1.75kg.



CODE	CAPACITY (L)	DIAMETER (MM)	DIMENSIONS (CM)	GENCOD	TRADE PACK	RRP (€)
TRIPOD BUCKET STAND						
ACS010373	—	32.5	—		1	69.99

FOLDABLE BUCKET

- Very practical bucket in waterproof PVC.
- Foldable for space saving.



CODE	CAPACITY (L)	DIAMETER (MM)	DIMENSIONS (CM)	GENCOD	TRADE PACK	RRP (€)
FOLDABLE BUCKET						
ACS140008	6	—	—		1	13.99

SET OF 4 POP-UP/DIP POTS

- Perfect for storing Pop-Ups and liquid soaked hook baits.
- The lid features an integrated 'O' ring to create a tight seal and prevent liquid escaping during transportation.



CODE	CAPACITY (L)	DIAMETER (MM)	DIMENSIONS (CM)	GENCOD	TRADE PACK	RRP (€)
SET OF 4 POP-UP/DIP POTS						
ACS140006	—	—	—		5	8.39



A.L.S MARKER

- Water sensors and Light Dependant Resistors (LDR's) work together so that the Hi-Viz red LEDs will automatically turn on only when the marker is placed in water and when it's dark.
- Accepts 2x AA Batteries.
- Up to 100 hours run time.

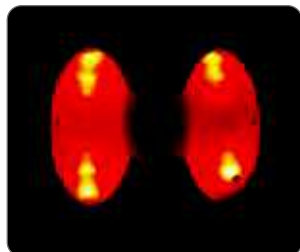

CODE	COLOUR	GENCOD	TRADE PACK	RRP (€)
A.L.S MARKER				
ACS010385	Orange		1	31.49

STATIC MARKER

- Made from a high buoyancy and Hi-Viz material, simply clip a large weight onto the snap link and drop over the edge of the boat to mark a spot.



CODE	DIMENSIONS (CM)	COLOUR	GENCOD	TRADE PACK	RRP (€)
STATIC MARKER					
ACS010382	12x10.8	Orange		3	7.09

BOILIE ROLLING TABLE

- Non-slip base.
- For making baits in sizes 14, 16, 18, 20 and 24mm.

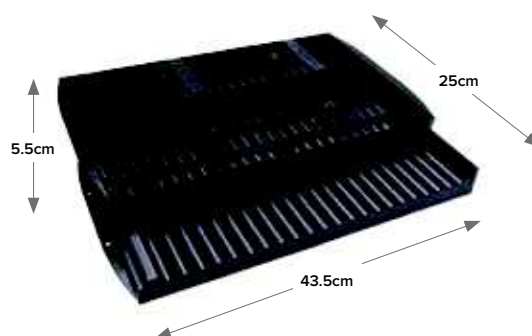
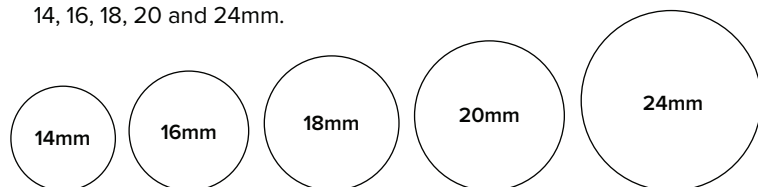

CODE	DIAMETER (MM)	GENCOD	TRADE PACK	RRP (€)
BOILIE ROLLING TABLE				
938000361	14		1	40.99
939000361	16		1	40.99
940000361	18		1	40.99
941000361	20		1	40.99
ACS010451	24		1	40.99

NEW 2025

PNEUMATIC ALUMINIUM BAIT GUN

- Strong & lightweight aluminium cylinder construction.
- Adjustable pressure valve.
- Supplied with nozzle that can be cut to any desired size – additional nozzles sold separately.
- Capacity 0.75L with a maximum input pressure of 145psi.



CODE	CAPACITY (L)	DIAMETER (MM)	DIMENSIONS (CM)	GENCOD	TRADE PACK	RRP (€)
PNEUMATIC ALUMINIUM BAIT GUN						
945000361	0.6	—	—		1	146.99

MANUAL ALUMINIUM BAIT GUN

- Features a 0.7l tube for injecting bait.
- Strong & lightweight aluminium cylinder construction.
- Supplied with nozzle that can be cut to any desired size – additional nozzles sold separately.



CODE	CAPACITY (L)	DIAMETER (MM)	DIMENSIONS (CM)	GENCOD	TRADE PACK	RRP (€)
MANUAL ALUMINIUM BAIT GUN						
944000361	0.7	—	—		1	57.49

BAIT GUN NOZZLE

- Graduated nozzle to ease the cutting to the desired diameter.



CODE	GENCOD	TRADE PACK	RRP (€)
BAIT GUN NOZZLE			
946000361		5	4.19

BAIT CRUSHER

- This version of the Bait Crusher features reinforced metal teeth, which will make light work of even hard baits such as nuts and seeds.



CODE	WEIGHT (G / KG)	FOR BAITS UP TO (MM)	LENGTH (CM)	COLOUR	GENCOD	TRADE PACK	RRP (€)
BAIT CRUSHER							
ACS010437	—	—	—	—		1	25.99

SINGLE / DOUBLE TERMINAL TACKLE BOX

- Rigid box to store terminal tackles.
- Tinted cover.

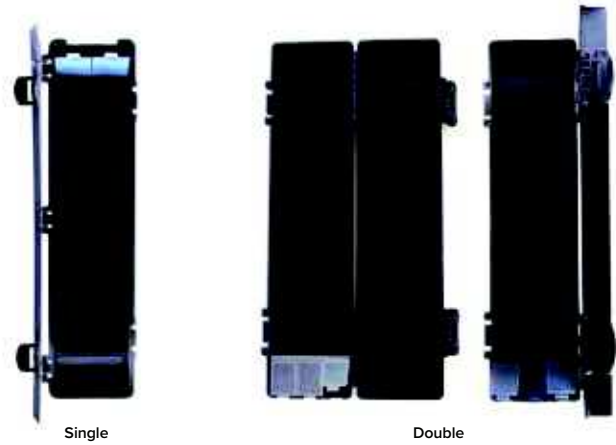

Single

Double

CODE	COLOUR	DIAMETER (MM)	DIMENSIONS (CM) LxWxD	SIZE (MM)	QUANTITY	GENCOD	TRADE PACK	RRP (€)
TERMINAL TACKLE BOX								
ACS140005 (S)	—	—	34 x 9.5 x 2.5	—	—		1	8.99
126000360 (D)	—	—	34 x 9.5 x 4.5	—	—		1	14.99

TACKLE BOX SET

- Tackle box to store all your accessories, braids, terminal tackle and is composed of:
 - x1 – large main tackle box with adjustable dividers.
 - x1 – rig storage box with foam inserts and pins x1.
 - x1 – small 2 section box.
 - x2 – small 3 section box.
 - x2 – small 4 section box.
- Tinted cover to protect your accessories from the sun.



x1 – small 2 section box

x2 – small 3 section boxes



x2 – small 4 section boxes



Large main tackle box with adjustable dividers x1

CODE	COLOUR	DIAMETER (MM)	DIMENSIONS (CM) LxWxD	SIZE (MM)	QUANTITY	GENCOD	TRADE PACK	RRP (€)
TACKLE BOX SET								
ACS140002	—	—	36 x 30	—	—		1	32.99

CLOTHING & WADERS



T-SHIRT

- Lightweight & cool
- Green T-shirt - 100% Cotton.
- Charcoal T-shirt - 60% Polyester/40% Cotton. 180gs T-Shirt.
- Printed front logo (Green & Charcoal). Printed back logo (Green Only).
- Woven sleeve logo.
- Available in sizes S/M/L/XL/XXL.



CODE	COLOUR	SIZE	GENCOD	TRADE PACK	RRP (€)
T-SHIRTS					
ACS680085	Green	S		1	17.99
ACS680072	Green	M		1	17.99
ACS680073	Green	L		1	17.99
ACS680074	Green	XL		1	17.99
ACS680086	Green	XXL		1	17.99
ACS680081	Charcoal	S		1	17.99
ACS680066	Charcoal	M		1	17.99
ACS680067	Charcoal	L		1	17.99
ACS680068	Charcoal	XL		1	17.99
ACS680082	Charcoal	XXL		1	17.99

HOODIE

- 60% Polyester/40% Cotton.
- 280gsm.
- Printed front logo (Green & Charcoal).
- Printed back logo (Green Only).
- Fully lined hood with drawstring adjustment.
- Moulded rubber sleeve badge.
- Elasticated waist & cuffs.
- Generous length to reduce 'rising up' whilst casting.
- Available in sizes S/M/L/XL/XXL.



CODE	COLOUR	SIZE	GENCOD	TRADE PACK	RRP (€)
HOODIES					
ACS680087	Green	S		1	39.99
ACS680075	Green	M		1	39.99
ACS680076	Green	L		1	39.99
ACS680077	Green	XL		1	39.99
ACS680088	Green	XXL		1	39.99
ACS680083	Charcoal	S		1	39.99
ACS680069	Charcoal	M		1	39.99
ACS680070	Charcoal	L		1	39.99
ACS680071	Charcoal	XL		1	39.99
ACS680084	Charcoal	XXL		1	39.99

JOGGERS

- 60% Polyester/40% Cotton.
- 280gsm.
- 2x zipped front pockets.
- 1x zipped rear pocket.
- Elasticated waist with drawstring adjustment.
- Elasticated ankles.
- Embroidered logo on rear pocket.
- Moulded rubber logo on leg.
- Available in sizes S/M/L/XL/XXL.



CODE	DESCRIPTION	COLOUR	SIZE	GENCOD	TRADE PACK	RRP (€)
JOGGERS						
ACS680089	Joggers	Green	S		1	36.99
ACS680078	Joggers	Green	M		1	36.99
ACS680079	Joggers	Green	L		1	36.99
ACS680080	Joggers	Green	XL		1	36.99
ACS680090	Joggers	Green	XXL		1	36.99



BERTRAND AMILIEN
 @amilien_bertrand_carplife

CAP

- 100% Cotton.



CODE	DESCRIPTION	COLOUR	SIZE	GENCOD	TRADE PACK	RRP (€)
CAPS						
ACS680058	Baseball	Black	One Size		1	7.99

SUNGLASSES NEW 2025

- Polarized sunglasses with 100% UVA and UVB protection.
- Polarized brown lens.
- Matte black+yellow rubber frame.
- Floating strap.
- Highly protective rigid case.
- Cleaning cloth included.



CODE	COLOUR	GENCOD	TRADE PACK	RRP (€)
SUNGLASSES				
ACS680101	Black		1	24.99

BOOTS

NEW 2025

- Carp Spirit neoprene boots combine comfort and protection in all weather and all seasons. They are very easy to put on and take off with optimal comfort, keeping your feet dry and warm during your fishing sessions. Thanks to its non-slip sole you can walk safely on uneven terrain along the banks.
- 5mm Neoprene boots.
- Moulded rubber sole.
- Steel reinforcement in the sole to protect the feet.
- Delivered in a cardboard box.
- Sizes 40 to 46.



CODE	MATERIAL	SIZE	GENCOD	TRADE PACK	RRP (€)
BOOTS					
ACS680103	Neoprene	40		1	89.99
ACS680104	Neoprene	41		1	89.99
ACS680105	Neoprene	42		1	89.99
ACS680106	Neoprene	43		1	89.99
ACS680107	Neoprene	44		1	89.99
ACS680108	Neoprene	45		1	89.99
ACS680109	Neoprene	46		1	89.99

